



2022 Product Catalog

RAIN[®]

Table of Contents

THE K-RAIN® STORY	01	ELECTRIC VALVES	48
		Valve Comparison Chart	49
ROTORS	02	ProSeries 100 Valves	50
Rotor Comparison Chart	03	ProSeries 150 Valves	52
MiniPro®	04	ProSeries 200 Valves	54
RPS™ 50	06	Valve Accessories	55
RPS™ 75	08		
RPS™ 75i	10	CONTROLLERS	56
RPS™ Select	14	Controller Comparison Chart	57
ProPlus®	16	SiteMaster	58
SuperPro®	18	PRO EX 2.0	60
ProSport®	22	PRO-LC	63
Rotor Accessories	24	RPS™ 46	64
		BLUE	65
SPRAYS	26	Rain Sensor	66
Spray Body Comparison Chart	27	Controller Accessories	67
Pro-S™	28		
NP Sprays	30	PUMP START RELAYS	68
K-Sprays	31		
Spray Accessories	32	SINGLE STATION CONTROLLER	69
NOZZLES	34	INDEXING VALVES	
Nozzle Comparison Chart	35	4000 Series Indexing Valve	70
Rotary Nozzle Series	36	6000 Series Indexing Valve	71
Fully Adjustable Rotary Nozzles	38		
High Efficiency KVF Nozzles	40	RECLAIMED WATER (RCW)	72
KV Nozzles	42		
Fixed Nozzles	44	Custom Products	74
		Premier Contractor Program	75
DRIP, BUBBLERS		Design Resources	76
Drip Irrigation	46	Charts	77
Bubblers	47	Warranty	88

Incorporated in 1972, K-Rain® Manufacturing started on the path to become one of the largest manufacturers of irrigation rotors, sprays, valves and controllers in the world.

The Early Years

As a young man, Carl Kah excelled in physics and chemistry and had a keen interest in electronics and aerodynamic design. While still in high school, he designed and built an early version of a cyclone vacuum cleaner. It would be the first of many inventions to come.

From Rockets to Rotors

With a degree in Chemical Engineering and after graduating first in his class from the U.S. Army Artillery Corps Guided Missile School, Carl began work in the Applied Research and Propulsion Division of Pratt & Whitney. His contribution there helped develop the early reusable rocket engines – a technology that is still used by NASA today.

In the evenings, out of concern for his own residential lawn, he used a lathe in his garage to design and machine a valve that cycled from zone to zone thus eliminating the need for multiple valves. Carl patented the valve in 1966.

In 1970, he invented and patented the Modulated Pressure Control. This allowed for the control of the entire irrigation system of a golf course without wires or tubes. The patent was later sold to a manufacturer of golf course irrigation systems. That patent sale was the catalyst to founding K-Rain® Manufacturing.

Expansion

Twelve years later in 1986, Chip Kah joined the business and led the development and growth of indexing valves for the wastewater disposal industry. And as early as 1991, K-Rain® introduced its first gear drive sprinkler. By 1993, Chip would be at the helm as president of the company.

1995 was a new turning point for the company. K-Rain® began expanded their products to retail and Carl's two daughters, Gretchen and Deborah Kah joined the business. Gretchen Kah would eventually lead the west coast sales division. Deborah Kah, an attorney, would be managing intellectual property and human resources.

Christopher Kah, Chip's oldest son, joined the business in 2016 and as recently as 2017 son Trevor officially came on board making it three generations driving the company.



A young Carl Kah working with a lathe

Engineering First

K-Rain® has always been an "engineering first" environment, continually seeking to pair ease-of-use with industry-leading technology. The commitment to quality has led the company to an ISO9001 quality certification in 2006. ISO is the quality standard for manufacturing and process control.

Carl himself holds over 80 patents specific to the irrigation industry including the three-spring reversing mechanism still used today in most gear driven sprinklers. He continues to use his engineering expertise and creativity to further develop innovative technology.

Sustainability is one of the top priorities at the company with a full range of products for reclaimed/recycled water. "Doing our part for a greener future is just part of our DNA," says Adrian Toribio, Director of Operations and Quality. "We're environmentally conscious about the materials we select and ensuring our manufacturing processes are highly energy efficient as well."

K-Rain® persists in leading the industry globally with new developments in rotor and nozzle engineering. "Our RPS™ 75i with Intelligent Flow Technology® is the only rotor of its type to significantly reduce water waste by regulating flow and distance proportionately and simultaneously," notes Chip. "Also, the RPS™ Select is another unique rotor with 4 built-in nozzles—select the pattern and select the equivalent nozzle for matched precipitation. And in the past few years, we've introduced new items such as blue tooth controllers for use with smart phones and WiFi enabled controllers."

Today

Over 400 men and women make up the K-Rain® team, serving customers in the United States and more than 60 countries worldwide. Beyond any technical advancement, people are at the heart of all we do. Every day we go to work with one thought: Make it better.

rotors



Rotor Comparison Chart

From small landscapes to sports stadiums, K-Rain has a rotor for every landscape. Designed and built to provide year after year high performance and low maintenance, K-Rain rotors deliver outstanding coverage on any terrain. Enjoy a comprehensive range of innovative features and exceptional functionality.

	MiniPro	RPS50	RPS75	RPS75i	RPS Select	ProPlus	SuperPro	ProSport
Specifications								
Inlet Size	1/2"	1/2"	3/4"	3/4"	3/4"	3/4"	3/4"	1"
Radius	17'-30'	17'-30'	22'-51'	26'-48'	33'-46'	22'-50'	26'-46'	43'-77'
Flow Range (GPM)	0.8-3.3	0.8-3.3	0.7-8.3	0.9-9.7	1.3-6.8	0.5-10.0	1.1-11.1	5.1-32.5
Features								
Pressure Rating (PSI)	20-70	20-70	20-70	20-70	20-70	20-70	20-70	40-90
Nozzle Trajectory	25°	25°	26°	26°	24°	26°	26°	26°
Pre-installed Nozzles	#1.5	#1.5	#3.0	#2.5	4 built-in selectable	#2.5	#2.5	#10
Low Angle Nozzle Choices			•	•		•	•	
Non-Strippable Drive (arc memory clutch)						•	•	•
Arc Adjustment Range	40°-360°	40°-360°	40°-360°	40°-360°	40°-360°	40° to cont. 360°	40° to cont. 360°	40° to cont. 360°
Top Arc Set Indication	•				•	•	•	•
Intelligent Flow Technology®				•			•	
Reclaimed Water Available	•		•	•	•	•	•	•
Stainless Steel Available			•	•				•
Optional or Factory Installed CV	•	•	•	•	•	•	•	Standard
Warranty	5 years	5 years	5 years	5 years	5 years	5 years	5 years	5 years

MiniPro®

Perfect for small lawn and landscape areas.

Features

- Revolutionary Patented Top Arc Set – Simplified arc set allows for wet or dry adjustment in seconds
- 1/2" Inlet – Replaces all standard mini rotors and pop-up sprays
- Adjustable to 360° – Full range of adjustment from 40° to 360°
- Patented Top Arc Set Degree Markings – Clearly indicates the current watering pattern and simplifies arc set adjustment
- Time Proven Patented Reversing Mechanism – Assures continuous reverse and return...over a 35 year history
- Rubber Cover – Seals out dirt and increases product durability
- Optional Check Valve – Prevents low head drainage

Specifications

- Arc Adjustment Range: 40° – 360°
- Flow Range: 0.8 – 3.3 GPM (3,0 – 12,5 LPM)
- Pressure Rating: 20 – 70 PSI (1,4 – 4,8 bar)
- Precipitation Rate: .26 – .60 in/hr (6,6 – 15,2 mm/hr) (depending on spacing and nozzle used)
- Recommended Spacing: 17' – 28' (5,2 – 9,1 m)
- Radius: 17' – 30' (5,2 – 9,2 m)
- Nozzle Trajectory: 25°

Easy Arc Setting

Arc Selection: 40° to 360°
Adjust from left start



Model

13003 4" (10,2 cm) MiniPro®

13006 6" (15,2 cm) MiniPro®

13012 12" (30,5 cm) MiniPro®

Accessories

See page 24-25

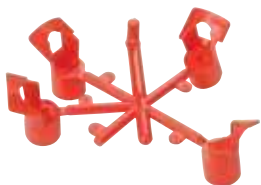

Fast Facts

All	Inlet: 1/2" (1,3 cm) female thread NPT
4"	Retracted height: 6" (15,2 cm) Riser height: 4" (10,2 cm)
6"	Retracted height: 8 3/8" (21,3 cm) Riser height: 6" (15,2 cm)
12"	Retracted height: 15 1/4" (38,7 cm) Riser height: 12" (30,5 cm)



Performance Data

NOZZLE	PRESSURE PSI	RADIUS Feet	FLOW GPM	PRECIP in/hr	
				■	▲
#0.75	30	17	0.8	.45	.51
	40	17	0.8	.43	.49
	50	18	0.9	.43	.50
#1.0	30	20	0.9	.26	.30
	40	21	1.2	.32	.37
	50	21	1.3	.34	.40
#1.5 Pre- installed	30	23	1.4	.34	.40
	40	24	1.7	.32	.37
	50	24	1.9	.34	.39
#2.0	30	25	1.8	.39	.44
	40	27	2.1	.42	.49
	50	27	2.4	.42	.49
#3.0	30	28	2.7	.48	.55
	40	30	3.0	.45	.51
	50	30	3.3	.52	.60

Performance Data, Metric

NOZZLE	PRESSURE Bar	RADIUS Meters	FLOW L/M	PRECIP mm/hr	
				■	▲
#0.75	2,07	5,2	2,8	11	13
	2,76	5,2	3,0	11	12
	3,45	5,5	3,4	11	13
#1.0	2,07	6,1	3,4	7	8
	2,76	6,4	4,5	8	9
	3,45	6,4	4,9	9	10
#1.5 Pre- installed	2,07	7,0	5,3	9	10
	2,76	7,3	6,4	8	9
	3,45	7,3	7,2	9	10
#2.0	2,07	7,6	6,8	10	11
	2,76	8,2	7,9	11	12
	3,45	8,2	9,1	11	12
#3.0	2,07	8,5	10,2	12	14
	2,76	9,1	11,4	11	13
	3,45	9,1	12,5	13	15

*All precipitation rates calculated for 180° operation.
For the precipitation rate for a 360° sprinkler, divide by 2.

How to Specify with Options

MODEL	OPTION
13003	-CV Check valve
13006	-NN No nozzle
13012	-RCW Reclaimed water use

Examples: 13003-NN, 13006-RCW-CV



RPS™ 50

Designed for smaller landscape areas.

Features

- Right Position Start
- Patented Reversing Mechanism – Continuous reverse and return
- Ideal for use in tandem with larger rotors
- Rubber Cover – Seals out dirt and increases product durability
- Comes with 5 Nozzles for system flexibility
- Optional Check Valve – Prevents low head drainage

Specifications

- Arc Adjustment Range: 40° – 360°
- Flow Range: .8 – 3.8 GPM (3,0 – 14,4 LPM)
- Pressure Rating: 20 – 70 PSI (1,4 – 4,8 bar)
- Precipitation Rate: .26 – .60 in/hr (6,6 – 15,2 mm/hr)
(depending on spacing and nozzle used)
- Recommended Spacing: 17' – 30' (5,2 – 9,2 m)
- Radius: 18' – 33' (5,5 – 10,1 m)
- Nozzle Trajectory: 25°

Easy Arc Setting

Arc Selection: 40° to 360°
Adjust from right start



Model

RPS50 RPS™ 50

Accessories

See page 24-25

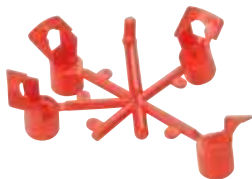

Fast Facts

Inlet: 1/2" (1,3 cm) female thread NPT

Retracted height: 6" (15,2 cm)

Riser height: 4" (10,2 cm)



Performance Data

NOZZLE	PRESSURE PSI	RADIUS Feet	FLOW GPM	PRECIP in/hr	
				■	▲
#0.75	30	17	0.8	.45	.51
	40	17	0.8	.43	.49
	50	18	0.9	.43	.50
#1.0	30	20	0.9	.26	.30
	40	21	1.2	.32	.37
	50	21	1.3	.34	.40
#1.5 Pre- installed	30	23	1.4	.34	.40
	40	24	1.7	.32	.37
	50	24	1.9	.34	.39
#2.0	30	25	1.8	.39	.44
	40	27	2.1	.42	.49
	50	27	2.4	.42	.49
#3.0	30	28	2.7	.48	.55
	40	30	3.0	.45	.51
	50	30	3.3	.52	.60

**All precipitation rates calculated for 180° operation.
For the precipitation rate for a 360° sprinkler, divide by 2.*

Performance Data, Metric

NOZZLE	PRESSURE Bar	RADIUS Meters	FLOW L/M	PRECIP mm/hr	
				■	▲
#0.75	2,07	5,2	2,8	11	13
	2,76	5,2	3,0	11	12
	3,45	5,5	3,4	11	13
#1.0	2,07	6,1	3,4	7	8
	2,76	6,4	4,5	8	9
	3,45	6,4	4,9	9	10
#1.5 Pre- installed	2,07	7,0	5,3	9	10
	2,76	7,3	6,4	8	9
	3,45	7,3	7,2	9	10
#2.0	2,07	7,6	6,8	10	11
	2,76	8,2	7,9	11	12
	3,45	8,2	9,1	11	12
#3.0	2,07	8,5	10,2	12	14
	2,76	9,1	11,4	11	13
	3,45	9,1	12,5	13	15

How to Specify with Options

MODEL	OPTION
RPS50	-CV Check valve
	-RCW Reclaimed Water Use

Example: RPS50-CV



RPS™ 75

Sets the standard for 3/4" gear-driven rotors.

Features

- Right Position Start
- Patented reversing mechanism feature ensures continuous reverse and return
- Full and Part Circle Rotation – Provides a full range of adjustment from 40° to 360°
- Non-flushing Wiper Seal – Reduces leaks caused by debris trapped under seal
- 3/4" (1,9 cm) Inlet – Replaces all standard rotors
- Ideal for Low Flow Applications
- Rubber Cover – Seals out dirt and increases durability
- Wide Selection of Nozzles – Including standard and low angle for flexibility in system design
- Includes 5 Free Check Valve Assemblies Per Box
- Universal Riser Assembly – Fits into existing Hunter® PGP® and PGP® Ultra cans

Specifications

- Arc Adjustment Range: 40° – 360°
- Flow Range: 0.7 – 8.3 GPM (2,6 – 31 LPM)
- Pressure Rating: 20 – 70 PSI (1,4 – 4,8 bar)
- Precipitation Rate: .16 – 1.0 in/hr (4 – 25,4 mm/hr) (depending on spacing and nozzle used)
- Recommended Spacing: 25' – 45' (7,6 – 13,7 m)
- Radius: 22' – 51' (6,7 – 15,5 m)
- Nozzle Trajectory: 26°
- Low Angle Nozzle Trajectory: 11°
- 8 Standard and 4 Low Angle Nozzles Included

Easy Arc Setting

Arc Selection: 40° to 360°
Adjust from right start



Accessories

See page 24-25

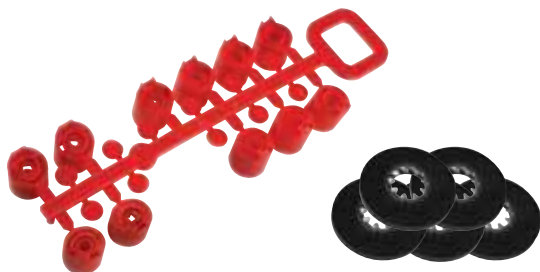

Fast Facts

All	Inlet: 3/4" (1,9 cm) female thread NPT
4"	Retracted height: 7 3/8" (19,7 cm) Riser height: 4 3/8" (11,1 cm)
6"	Retracted height: 9 1/2" (24,1 cm) Riser height: 6 3/8" (16,2 cm)
Shrub	Height: 7 1/2" (19,1 cm)



Models

RPS75	RPS™ 75 Rotor
RPS75-360°	RPS™ 75 Rotor, 360°
RPS75-SH	RPS™ 75 Rotor, Shrub
RPS75-360°-SH	RPS™ 75 Rotor, 360°, Shrub
RPS75-6INCH	6" (15,2 cm) RPS™ 75 Rotor

How to Specify with Options

MODEL	OPTION
RPS75	-SS Stainless Steel
RPS75-360°	-CV Check valve
RPS75-SH	-NN No nozzle
RPS75-360°-SH	-RCW Reclaimed water use
RPS75-6INCH	-PR Pressure Regulation (6" only)



Examples: RPS75-SS, RPS75-360°-RCW-CV

Performance Data

NOZZLE	PRESSURE PSI	RADIUS Feet	FLOW GPM	PRECIP in/hr	
				■	▲
#0.75	30	29	0.7	.16	.19
	40	30	0.8	.17	.20
	50	30	0.9	.19	.22
	60	31	1.0	.20	.23
#1.0	30	30	0.9	.19	.22
	40	31	1.0	.20	.23
	50	31	1.2	.24	.28
	60	32	1.3	.24	.28
#1.5	30	32	1.2	.23	.26
	40	33	1.4	.25	.29
	50	34	1.6	.27	.31
	60	34	1.8	.30	.35
#2.0	30	34	1.6	.27	.31
	40	36	1.8	.27	.31
	50	38	2.0	.27	.31
	60	38	2.2	.29	.34
#3.0 Pre- installed	30	36	2.0	.30	.34
	40	38	2.4	.32	.37
	50	40	2.7	.32	.38
	60	40	2.9	.35	.40
#4.0	30	36	2.6	.39	.45
	40	40	3.0	.36	.42
	50	42	3.4	.37	.43
	60	42	3.7	.40	.47
#6.0	40	38	4.2	.56	.65
	50	43	4.9	.51	.59
	60	46	5.5	.50	.58
	70	47	6.0	.52	.60
#8.0	40	45	6.0	.57	.66
	50	48	6.8	.57	.66
	60	49	7.6	.61	.70
	70	51	8.2	.61	.70

Performance Data, Metric

NOZZLE	PRESSURE Bar	RADIUS Meters	FLOW L/M	PRECIP mm/hr	
				■	▲
#0.75	2,1	8,8	2,6	4	5
	2,8	9,1	3,0	4	5
	3,4	9,1	3,4	5	6
	4,1	9,4	3,8	5	6
#1.0	2,1	9,1	3,4	5	6
	2,8	9,4	3,8	5	6
	3,4	9,4	4,5	6	7
	4,1	9,8	4,9	6	7
#1.5	2,1	9,8	4,5	5	7
	2,8	10,1	5,3	6	7
	3,4	10,4	6,1	7	8
	4,1	10,4	6,8	8	9
#2.0	2,1	10,4	6,1	7	8
	2,8	11,0	6,8	7	8
	3,4	11,6	7,6	7	8
	4,1	11,6	8,3	7	9
#3.0 Pre- installed	2,1	11,0	7,6	8	9
	2,8	11,6	9,1	8	9
	3,4	12,2	10,2	8	10
	4,1	12,2	11,0	9	10
#4.0	2,1	11,0	9,8	10	11
	2,8	12,2	11,4	9	11
	3,4	12,8	12,9	9	11
	4,1	12,8	14,0	10	12
#6.0	2,8	11,6	15,9	14	17
	3,4	13,1	18,5	13	15
	4,1	14,0	20,8	13	15
	4,8	14,3	22,7	13	15
#8.0	2,8	13,7	22,7	14	17
	3,4	14,6	25,7	14	17
	4,1	14,9	28,8	15	18
	4,8	15,5	31,0	15	18

Low Angle Performance Data

NOZZLE	PRESSURE PSI	RADIUS Feet	FLOW GPM	PRECIP in/hr	
				■	▲
#1.0	30	22	1.2	.48	.55
	40	24	1.7	.57	.66
	50	26	1.8	.51	.59
	60	28	2.0	.49	.57
#3.0	30	29	3.0	.69	.79
	40	32	3.1	.58	.67
	50	35	3.5	.55	.64
	60	37	3.8	.53	.62
#4.0	30	31	3.4	.68	.79
	40	34	3.9	.65	.75
	50	37	4.4	.62	.71
	60	38	4.7	.63	.72
#6.0	40	38	6.5	.87	1.00
	50	40	7.3	.88	1.01
	60	42	8.0	.87	1.01
	70	44	8.3	.86	0.99

Low Angle Performance Data, Metric

NOZZLE	PRESSURE Bar	RADIUS Meters	FLOW L/M	PRECIP mm/hr	
				■	▲
#1.0	2,1	6,7	4,5	12	14
	2,8	7,3	6,4	14	17
	3,4	7,9	6,8	13	15
	4,1	8,5	7,6	12	14
#3.0	2,1	8,8	11,4	18	20
	2,8	9,8	11,7	15	17
	3,4	10,7	13,2	14	16
	4,1	11,3	14,4	13	16
#4.0	2,1	9,4	12,9	17	20
	2,8	10,4	14,8	17	19
	3,4	11,3	16,7	16	18
	4,1	11,6	17,8	16	18
#6.0	2,8	11,6	24,6	22	25
	3,4	12,2	27,6	22	26
	4,1	12,8	30,3	22	26
	4,8	13,4	32,6	22	25

Watch the video. Scan this code with your smartphone camera.



*All precipitation rates calculated for 180° operation
For the precipitation rate for a 360° sprinkler, divide by 2.

RPS™ 75i

With Patented Intelligent Flow Technology®.

Features

- Reduce Distance and Flow Rate Simultaneously and Proportionately up to 50%
- Rugged RPS Family Construction
- Superior Uniformity, Conserves Water, Fewer Zones Required
- Save Time on Every Project — New or retrofit
- Includes 5 Free Check Valve Assemblies Per Box
- Universal Riser Assembly – Fits into existing Hunter® PGP® and PGP® Ultra cans

Specifications

- Arc Adjustment Range: 40° – 360°
- Flow Range: 0.9 – 9.7 GPM (3,4 – 36,7 LPM)
- Pressure Rating: 20 – 70 PSI (1,4 – 4,8 bar)
- Precipitation Rate: .22 – .98 in/hr (6 – 24,9 mm/hr)
- Recommended Spacing: 17' – 45' (5,2 – 13,7 m)
- Radius: 26' – 48' (7,9 – 14,6 m)
- Nozzle Trajectory: 26°
- Low Angle Nozzle Trajectory: 11°
- Nozzles Included: 8 Standard, 4 Low Angle

Models

RPS 75i	RPS™ 75i Rotor
RPS75i-360°	RPS™ 75i Rotor, 360°
RPS75i-SH	RPS™ 75i Rotor, Shrub
RPS75i-360°-SH	RPS™ 75i Rotor, Shrub, 360°
RPS75i-6INCH	6" (15,2 cm) RPS™ 75i Rotor

Accessories

See page 24-25

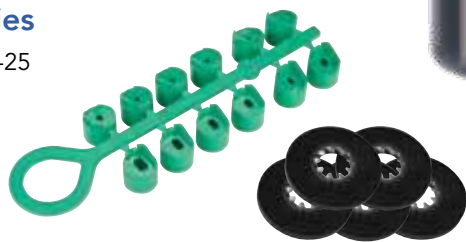

Fast Facts

All	Inlet: 3/4" (1,9 cm) female thread NPT
4"	Retracted height: 7 3/8" (19,7 cm) Riser height: 4 1/4" (10,8 cm)
6"	Retracted height: 9 1/2" (24,1 cm) Riser height: 6 1/4" (15,9 cm)
Shrub	Height: 7 1/2" (19,1 cm)



Performance Data

NOZZLE	PRESSURE PSI	NO ADJUSTMENT				-30% ADJUSTMENT			
		RADIUS Feet	FLOW GPM	PRECIP in/hr ■ ▲		RADIUS Feet	FLOW GPM	PRECIP in/hr ■ ▲	
#1.0	30	31	1.1	.22	.25	22	0.8	.31	.36
	40	32	1.4	.26	.30	22	1.0	.38	.43
	50	33	1.6	.28	.33	23	1.1	.40	.47
	60	34	1.8	.30	.35	24	1.3	.43	.49
#1.5	30	33	1.5	.27	.31	23	1.1	.38	.44
	40	35	1.8	.28	.33	25	1.3	.40	.47
	50	35	2.0	.31	.36	25	1.4	.45	.52
	60	36	2.2	.33	.38	25	1.5	.47	.54
#2.0	30	33	1.8	.32	.37	23	1.3	.45	.53
	40	34	2.1	.35	.40	24	1.5	.50	.58
	50	36	2.4	.36	.41	25	1.7	.51	.59
	60	38	2.7	.36	.42	27	1.9	.51	.59
#2.5 Pre- installed	30	35	2.2	.35	.40	25	1.5	.49	.57
	40	38	2.6	.35	.40	27	1.8	.50	.57
	50	39	3.0	.38	.44	27	2.1	.54	.63
	60	40	3.3	.40	.46	28	2.3	.57	.66
#3.0	30	38	2.7	.36	.42	27	1.9	.51	.59
	40	40	3.1	.37	.43	28	2.2	.53	.62
	50	41	3.5	.40	.46	29	2.5	.57	.66
	60	41	3.9	.45	.52	29	2.7	.64	.74
#4.0	30	38	3.5	.47	.54	27	2.5	.67	.77
	40	40	4.0	.48	.56	28	2.8	.69	.79
	50	43	4.4	.46	.53	30	3.1	.65	.76
	60	43	4.9	.51	.59	30	3.4	.73	.84
#5.0	30	43	4.4	.46	.53	30	3.1	.65	.76
	40	43	5.0	.52	.60	30	3.5	.74	.86
	50	44	5.5	.55	.63	31	3.9	.78	.90
	60	42	5.9	.64	.74	29	4.1	.92	1.06
#6.0	30	40	5.0	.60	.70	28	3.5	.86	.99
	40	43	5.9	.61	.71	30	4.1	.88	1.01
	50	43	6.6	.69	.79	30	4.6	.98	1.13
	60	44	7.3	.73	.84	31	5.1	1.04	1.20
#8.0	30	43	6.8	.71	.82	30	4.8	1.01	1.17
	40	47	7.9	.69	.80	33	5.5	.98	1.14
	50	48	8.8	.74	.85	34	6.2	1.05	1.21
	60	47	9.7	.85	.98	33	6.8	1.21	1.40

Low Angle Performance Data

NOZZLE	PRESSURE PSI	NO ADJUSTMENT				-30% ADJUSTMENT			
		RADIUS Feet	FLOW GPM	PRECIP in/hr ■ ▲		RADIUS Feet	FLOW GPM	PRECIP in/hr ■ ▲	
#1.0	30	26	0.9	.25	.29	18	0.6	.35	.41
	40	27	1.0	.26	.31	19	0.7	.38	.44
	50	27	1.2	.32	.37	19	0.8	.45	.52
	60	26	1.4	.40	.46	18	1.0	.57	.66
#1.5	30	28	1.3	.32	.37	20	0.9	.46	.53
	40	29	1.5	.34	.40	20	1.1	.49	.57
	50	30	1.7	.36	.42	21	1.2	.52	.60
	60	31	1.9	.38	.44	22	1.3	.54	.63
#2.0	30	29	1.9	.44	.50	20	1.3	.62	.72
	40	32	2.2	.41	.48	22	1.5	.59	.68
	50	33	2.5	.44	.51	23	1.8	.63	.73
	60	34	2.8	.47	.54	24	2.0	.67	.77
#3.0	30	32	2.5	.47	.54	22	1.8	.67	.78
	40	34	3.0	.50	.58	24	2.1	.71	.82
	50	35	3.5	.55	.64	25	2.5	.79	.91
	60	36	4.0	.59	.69	25	2.8	.85	.98

*All precipitation rates calculated for 180° operation.
For the precipitation rate for a 360° sprinkler, divide by 2.

Easy Arc Setting

Arc Selection: 40° to 360°
Adjust from right start



Intelligent Flow
Technology®

How to Specify with Options

MODEL	OPTION
RPS75i	-SS Stainless Steel
RPS75i-360°	-CV Check valve
RPS75i-SH	-NN No nozzle
RPS75i-360°-SH	-RCW Reclaimed water use
RPS75i-6INCH	-PR Pressure Regulation (6" only) NEW

Examples: RPS75i-NN, RPS75-360°-RCW



Watch the video. Scan this code
with your smartphone camera.

RPS™ 75i

Performance Data, Metric

NOZZLE	NO ADJUSTMENT						-30% ADJUSTMENT			
	PRESSURE		RADIUS	FLOW	PRECIP mm/hr		RADIUS	FLOW	PRECIP mm/hr	
	kPa	Bar	Meters	L/M	■	▲	Meters	L/M	■	▲
#1.0	207	2,1	9,4	4,2	6	6	7	3,0	8	9
	276	2,8	9,8	5,3	7	8	7	3,8	10	11
	345	3,4	10,1	6,1	7	8	7	4,1	10	12
	414	4,1	10,4	6,8	8	9	7	4,9	11	12
#1.5	207	2,1	10,1	5,7	7	8	7	4,1	10	11
	276	2,8	10,7	6,8	7	8	8	4,9	10	12
	345	3,4	10,7	7,6	8	9	8	5,3	11	13
	414	4,1	11,0	8,3	8	10	8	5,7	12	14
#2.0	207	2,1	10,1	6,8	8	9	7	4,9	11	13
	276	2,8	10,4	7,9	9	10	7	5,7	13	15
	345	3,4	11,0	9,1	9	10	8	6,4	13	15
	414	4,1	11,6	10,2	9	11	8	7,2	13	15
#2.5 Pre- installed	207	2,1	10,7	8,3	9	10	8	5,7	12	14
	276	2,8	11,6	9,8	9	10	8	6,8	13	14
	345	3,4	11,9	1,4	10	11	8	7,9	14	16
	414	4,1	12,2	2,5	10	12	9	8,7	14	17
#3.0	207	2,1	11,6	10,2	9	11	8	7,1	13	15
	276	2,8	12,2	11,7	9	11	9	8,3	13	16
	345	3,4	12,5	13,3	10	12	9	9,5	14	17
	414	4,1	12,5	14,8	11	13	9	10,2	16	19
#4.0	207	2,1	11,6	13,3	12	14	8	9,5	17	20
	276	2,8	12,2	15,1	12	14	9	10,6	18	20
	345	3,4	13,1	16,7	12	13	9	11,7	17	19
	414	4,1	13,1	18,6	13	15	9	12,9	19	21
#5.0	207	2,1	13,1	6,7	12	13	9	11,7	17	19
	276	2,8	13,1	18,9	13	15	9	13,3	19	22
	345	3,4	13,4	20,8	14	16	9	14,8	20	23
	414	4,1	12,8	22,3	16	19	9	15,5	23	27
#6.0	207	2,1	12,2	18,9	15	18	9	13,3	22	25
	276	2,8	13,1	22,3	15	18	9	15,5	22	26
	345	3,4	13,1	25,0	18	20	9	17,4	25	29
	414	4,1	13,4	27,6	19	21	9	19,3	26	30
#8.0	207	2,1	13,1	25,7	18	21	9	18,2	26	30
	276	2,8	14,3	29,9	18	20	10	20,8	25	29
	345	3,4	14,6	33,3	19	22	10	23,5	27	31
	414	4,1	14,3	36,7	22	25	10	25,7	31	35

Low Angle Performance Data, Metric

NOZZLE	NO ADJUSTMENT						-30% ADJUSTMENT			
	PRESSURE		RADIUS	FLOW	PRECIP mm/hr		RADIUS	FLOW	PRECIP mm/hr	
	kPa	Bar	Meters	L/M	■	▲	Meters	L/M	■	▲
#1.0	207	2,1	7,9	3,4	6	7	5	2,3	9	10
	276	2,8	8,2	3,8	7	8	6	2,7	10	11
	345	3,4	8,2	4,5	8	9	6	3,0	11	13
	414	4,1	7,9	5,3	10	12	5	3,8	14	17
#1.5	207	2,1	8,5	4,9	8	9	6	3,4	12	13
	276	2,8	8,8	5,7	9	10	6	4,2	12	14
	345	3,4	9,1	6,4	9	11	6	4,5	13	15
	414	4,1	9,4	7,2	10	11	7	4,9	14	16
#2.0	207	2,1	8,8	7,2	11	13	6	4,9	16	18
	276	2,8	9,8	8,3	10	12	7	5,7	15	17
	345	3,4	10,1	9,5	11	13	7	6,8	16	19
	414	4,1	10,4	10,6	12	14	7	7,6	17	20
#3.0	207	2,1	9,8	9,5	13	14	7	6,8	17	20
	276	2,8	10,4	11,4	14	15	7	7,9	18	21
	345	3,4	10,7	13,3	14	16	8	9,5	20	23
	414	4,1	11,0	15,1	15	18	8	10,6	22	25

*All precipitation rates calculated for 180° operation.
For the precipitation rate for a 360° sprinkler, divide by 2.





RPS™ Select

Four built-in selectable nozzles for the fastest nozzle change of any rotor.

Features

- All adjustments made from the top – wet or dry – including flow shutoff. No special tools needed
- Four Built-in Selectable Nozzles – Nozzles #1 through #4 match arc settings 90° through 360°
- Matched Precipitation Rates – When nozzle setting matched to arc
- Precision-Engineered Nozzles – Ensures water-saving efficiency
- Standard Rubber Cover
- Proven Water-lubricated Gear-drive Design – Common to the popular RPS™ 75 Series
- Low-pressure Operation
- Universal Riser Assembly – Fits into existing Hunter® PGP® and PGP® Ultra cans

Specifications

- Arc Adjustment Range: 40° – 360°
- Flow Range: 1.3 – 6.8 GPM (4,9 – 25,8 LPM)
- Pressure Rating: 20 – 70 PSI (1,4 – 4,8 bar)
- Precipitation Rate: .23 – .71 in/hr (6 – 20 mm/hr) (depending on spacing and nozzle used)
- Recommended Spacing: 31' – 44' (9,4 – 13,4 m)
- Radius: 33' – 46' (10 – 14 m)
- Nozzle Trajectory: 24°

Models

- 60003** RPS™ Select Rotor
60003-SH RPS™ Select Rotor, Shrub
60003-6INCH 6" (15,2 cm) RPS™ Select Rotor

Fast Facts

All	Inlet: 3/4" (1,9 cm) female thread NPT
4"	Retracted height: 7 3/8" (19,7 cm) Riser height: 4 3/8" (11,1 cm)
6"	Retracted height: 9 1/2" (24,1 cm) Riser height: 6 3/8" (16,2 cm)
Shrub	Height: 7 5/8" (16,8 cm)



Nozzle Selector

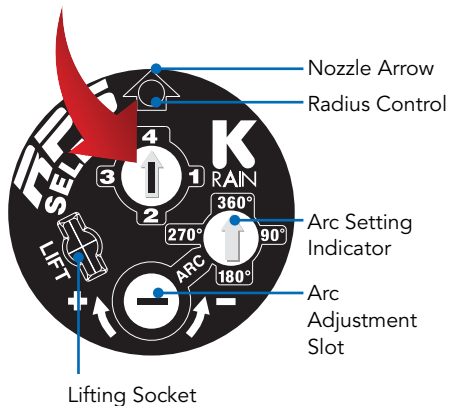

Performance Data

NOZZLE	PRESSURE PSI	RADIUS Feet	FLOW GPM	PRECIP in/hr	
				■	▲
#1.0	30	33'	1.3	.23	.24
	35	34'	1.4	.23	.27
	40	37'	1.5	.21	.29
	45	37'	1.6	.22	.26
	50	37'	1.8	.25	.29
#2.0	30	37'	2.6	.37	.42
	35	38'	2.8	.37	.43
	40	39'	3.0	.38	.44
	45	40'	3.2	.39	.44
	50	40'	3.6	.43	.50
#3.0	30	37'	3.8	.53	.62
	35	40'	4.1	.49	.57
	40	41'	4.5	.52	.60
	45	41'	4.7	.54	.62
	50	43'	4.9	.51	.59
#4.0	30	38'	5.2	.69	.80
	35	40'	5.7	.69	.79
	40	44'	6.0	.60	.69
	45	45'	6.4	.61	.70
	50	46'	6.8	.62	.71

Performance Data, Metric

NOZZLE	PRESSURE Bar	RADIUS Meters	FLOW L/M	PRECIP mm/hr	
				■	▲
#1.0	2,1	10,1	4,9	6	6
	2,4	10,4	5,3	6	7
	2,8	10,4	5,7	5	7
	3,1	11,3	6,1	6	7
	3,4	11,3	6,8	6	7
#2.0	2,1	11,3	9,8	9	11
	2,4	11,6	10,6	9	11
	2,8	11,9	11,4	10	11
	3,1	12,2	12,1	10	11
	3,4	12,2	13,6	11	13
#3.0	2,1	11,3	14,4	13	16
	2,4	12,2	15,5	12	14
	2,8	12,2	17,0	13	15
	3,1	12,5	17,8	14	16
	3,4	13,1	18,5	13	15
#4.0	2,1	11,6	19,6	18	20
	2,4	12,2	21,5	18	20
	2,8	13,4	22,7	15	18
	3,1	13,7	24,2	15	18
	3,4	14,0	25,7	16	18

*All precipitation rates calculated for 180° operation.
For the precipitation rate for a 360° sprinkler, divide by 2.

How to Specify with Options

MODEL	OPTION
60003	-CV Check valve
60003-SH	-RCW Reclaimed water use
60003-6INCH	

Examples: 60003-6INCH-CV, 60003-RCW

Accessories

See page 24-25



Watch the video. Scan this code with your smartphone camera.



ProPlus®

Tough, proven and advanced.

Features

- Patented Top Arc Set – Allows for wet or dry adjustment in seconds
- Full arc range adjustment from 40° to continuous 360°
- Patented Arc Set Degree Markings – Clearly indicates current watering pattern & simplifies arc set adjustment
- Arc Memory Clutch – Prevents internal gear damage and returns rotor to its prior setting automatically if nozzle turret is forced past its stop
- Patented Reversing Mechanism – Assures continuous reverse and return
- Ratcheting Riser – Allows for easy adjustment of the fixed starting position with a simple turn of the riser
- Rubber Cover – Seals out dirt, increases product durability
- Wide Selection of Nozzles – Including standard and low angle, provides flexibility in system design
- Replaces all standard rotors
- Optional Check Valve – Prevents low head drainage

Specifications

- Arc Adjustment Range: 40° to Continuous 360°
- Flow Range: .5 – 10.0 GPM (1,9 – 37,8 LPM)
- Pressure Rating: 20 – 70 PSI (1,4 – 4,8 bar)
- Precipitation Rate: .12 – 1.01 in/hr (3 – 25,7 mm/hr) (depending on spacing and nozzle used)
- Recommended Spacing: 28' – 44' (8,5 – 13,4 m)
- Radius: 22' – 50' (6,7 – 15,2 m)
- Nozzle Trajectory: 26°
- Low Angle Nozzle Trajectory: 12°
- Standard and Low Angle Nozzles Included

Model

11003 ProPlus®

Accessories

See page 24-25

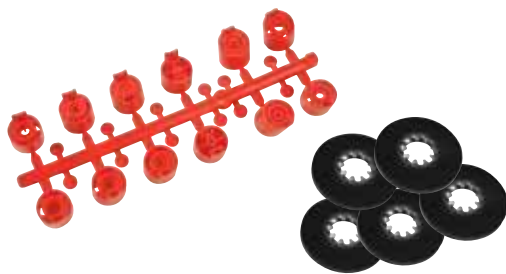

Fast Facts

Inlet:	3/4" (1,9 cm) female thread NPT
Retracted height:	7 1/2" (19 cm)
Riser height:	4 1/4" (10,8 cm)

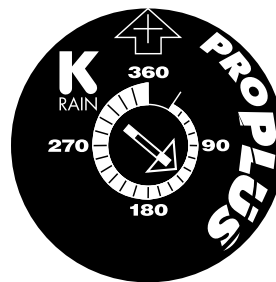

Easy Arc Setting

Arc Selection: 40° to continuous 360°
Adjust from left start



Performance Data

NOZZLE	PRESSURE PSI	RADIUS Feet	FLOW GPM	PRECIP in/hr	
				■	▲
#0.5	30	28	0.5	.12	.14
	40	29	0.6	.14	.16
	50	29	0.7	.16	.19
	60	30	0.8	.17	.20
#0.75	30	29	0.7	.16	.19
	40	30	0.8	.17	.20
	50	31	0.9	.18	.21
	60	32	1.0	.19	.22
#1.0	30	32	1.3	.24	.28
	40	33	1.5	.27	.31
	50	34	1.6	.27	.31
	60	35	1.8	.28	.33
#2.0	30	37	2.4	.34	.39
	40	40	2.5	.30	.35
	50	42	3.0	.33	.38
	60	43	3.3	.34	.36
#2.5 Pre- installed	30	38	2.5	.33	.38
	40	39	2.8	.35	.41
	50	40	3.2	.39	.44
	60	41	3.5	.40	.46
#3.0	30	38	3.6	.48	.55
	40	39	4.2	.53	.61
	50	41	4.6	.53	.61
	60	42	5.0	.55	.63
#4.0	30	43	4.4	.46	.53
	40	44	5.1	.51	.59
	50	46	5.6	.51	.59
	60	49	5.9	.47	.55
#6.0	40	45	5.9	.56	.65
	50	46	6.0	.55	.63
	60	48	6.3	.53	.61
	70	49	6.7	.54	.62
#8.0	40	42	8.0	.87	1.01
	50	45	8.5	.81	.93
	60	49	9.5	.76	.88
	70	50	10.0	.77	.89

Performance Data, Metric

NOZZLE	PRESSURE Bar	RADIUS Meters	FLOW L/M	PRECIP mm/hr	
				■	▲
#0.5	2,1	8,5	1,9	3	4
	2,8	8,8	2,3	4	4
	3,4	8,8	2,7	4	5
	4,1	9,1	3,0	5	5
#0.75	2,1	8,8	2,7	4	5
	2,8	9,1	3,0	4	5
	3,4	9,4	3,4	5	5
	4,1	9,8	3,8	5	6
#1.0	2,1	9,8	4,9	6	7
	2,8	10,1	5,7	7	8
	3,4	10,4	6,1	7	8
	4,1	10,7	6,8	7	8
#2.0	2,1	11,3	9,1	9	10
	2,8	12,2	9,5	8	9
	3,4	12,8	11,4	8	10
	4,1	13,1	11,4	8	9
#2.5 Pre- installed	2,1	11,6	9,5	8	10
	2,8	11,9	10,6	9	10
	3,4	12,2	12,1	10	11
	4,1	12,5	13,3	10	12
#3.0	2,1	11,6	13,6	12	14
	2,8	11,9	15,9	13	15
	3,4	12,5	17,4	13	15
	4,1	12,8	19,0	14	16
#4.0	2,1	13,1	16,7	12	13
	2,8	13,4	19,3	13	15
	3,4	14,0	21,2	13	15
	4,1	14,9	22,4	12	14
#6.0	2,8	13,7	22,4	14	17
	3,4	14,0	22,7	14	16
	4,1	14,6	23,9	13	15
	4,8	14,9	25,4	14	16
#8.0	2,8	12,8	30,3	22	26
	3,4	13,7	32,2	21	24
	4,1	14,9	36,0	19	22
	4,8	15,2	37,9	20	23

Low Angle Performance Data

NOZZLE	PRESSURE PSI	RADIUS Feet	FLOW GPM	PRECIP in/hr	
				■	▲
#1.0	30	22	1.2	.48	.55
	40	24	1.7	.57	.66
	50	26	1.8	.51	.59
	60	28	2.0	.49	.57
#3.0	30	29	3.0	.69	.79
	40	32	3.1	.58	.67
	50	35	3.5	.55	.64
	60	37	3.8	.53	.62
#4.0	30	31	3.4	.68	.79
	40	34	3.9	.65	.75
	50	37	4.4	.62	.71
	60	38	4.7	.63	.72
#6.0	40	38	6.5	.87	1.00
	50	40	7.3	.88	1.01
	60	42	8.0	.87	1.01
	70	44	8.3	.86	0.99

Low Angle Performance Data, Metric

NOZZLE	PRESSURE Bar	RADIUS Meters	FLOW L/M	PRECIP mm/hr	
				■	▲
#1.0	2,1	6,7	4,5	12	14
	2,8	7,3	6,4	14	17
	3,4	7,9	6,8	13	15
	4,1	8,5	7,6	12	14
#3.0	2,1	8,8	11,4	18	20
	2,8	9,8	11,7	15	17
	3,4	10,7	13,2	14	16
	4,1	11,3	14,4	14	16
#4.0	2,1	9,4	12,9	17	20
	2,8	10,4	14,8	17	19
	3,4	11,3	16,7	16	18
	4,1	11,6	17,8	16	18
#6.0	2,8	11,6	24,6	22	25
	3,4	12,2	27,7	22	26
	4,1	12,8	30,3	22	26
	4,8	13,4	32,6	22	25

*All precipitation rates calculated for 180° operation. For the precipitation rate for a 360° sprinkler, divide by 2.

How to Specify with Options

MODEL	OPTION
11003	-CV Check valve
	-LA Low angle nozzle
	-NN No nozzle
	-RCW Reclaimed water use

Example: 11003-RCW-CV

SuperPro®

All the best features in one rotor including Intelligent Flow Technology®.

Features

- Patented Intelligent Flow Technology® – Reduce distance and water flow simultaneously and proportionately up to 50%. Water savings of up to 30%
- Patented easy arc set – Simplified setting wet or dry. Water flow can be turned off or adjusted in the popped-up position
- Adjustable or continuous rotation – Provides a full range of adjustment from 40° to continuous 360°
- Patented arc set degree markings – Clearly indicates current watering pattern, simplifies arc set adjustment
- Arc memory clutch – Prevents internal gear damage and returns rotor to its prior setting automatically if nozzle turret is forced out of adjustment
- Patented reversing mechanism – Assures continuous reverse and return
- Ratcheting riser – Allows for easy adjustment of your left starting position with a simple turn of the riser
- Rubber cover – Seals out dirt and increases durability
- Optional check valve – Prevents low head drainage
- Rugged stainless steel spring – .093 gauge 302 stainless steel spring extends the life of the rotor

Specifications

- Arc adjustment range: 40° to continuous 360°
- Flow range: .8 – 11.1 GPM (3,0 – 42,0 LPM)
- Pressure rating: 20 – 70 PSI (1,4 – 4,8 bar)
- Precipitation rate: .21 – 1.17 in/hr (5,3 – 29,7 mm/hr) (depending on spacing and nozzle used)
- Recommended spacing: 28' – 44' (8,5 – 13,4 m)
- Radius: 26' – 46' (7,9 – 14,0 m)
- Nozzle trajectory: 26°
- Low angle nozzle trajectory: 12°
- Standard and low angle nozzles included
- #3 low angle nozzle pre-installed

Models

- 10003** SuperPro
- 10003-HP** SuperPro High Pop
- 10003-SH** SuperPro Shrub

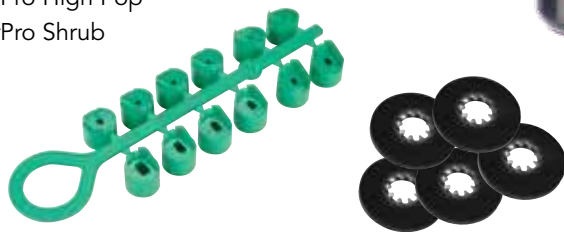

Fast Facts

All	Inlet: 3/4" (1,9 cm) female thread NPT
Standard	Retracted height: 7 1/2" (19,0 cm) Riser height: 4 3/4" (12,1 cm)
High pop	Retracted height: 17 (43,2 cm) Riser height: 11 1/2" (29,2 cm)
Shrub	Height: 7 3/4" (19,7 cm)



Performance Data

NOZZLE	PRESSURE PSI	NO ADJUSTMENT				-30% ADJUSTMENT			
		RADIUS Feet	FLOW GPM	PRECIP in/hr ■ ▲		RADIUS Feet	FLOW GPM	PRECIP in/hr ■ ▲	
#1.0	30	30	1.2	.21	.25	21	0.8	.30	.36
	40	31	1.3	.23	.27	22	0.9	.33	.39
	50	31	1.5	.27	.31	22	1.1	.39	.44
	60	32	1.8	.32	.37	22	1.3	.46	.53
#1.5	30	36	1.5	.22	.26	25	1.1	.31	.37
	40	37	1.8	.25	.29	26	1.3	.36	.41
	50	37	2.0	.28	.32	26	1.4	.40	.46
	60	38	2.2	.29	.34	27	1.5	.41	.49
#2.0	30	35	1.8	.28	.33	25	1.3	.40	.47
	40	35	2.2	.35	.40	25	1.5	.50	.57
	50	36	2.6	.39	.45	25	1.8	.56	.64
	60	38	2.9	.39	.45	27	2.0	.56	.64
#2.5 Pre- installed	30	37	2.5	.35	.41	26	1.8	.50	.59
	40	38	3.0	.40	.46	27	2.1	.57	.66
	50	40	3.4	.41	.47	28	2.4	.59	.67
	60	40	3.8	.46	.53	28	2.7	.66	.76
#3.0	30	36	3.0	.45	.51	25	2.1	.64	.73
	40	37	3.4	.48	.55	26	2.4	.69	.79
	50	38	4.0	.53	.62	27	2.8	.76	.89
	60	41	4.4	.50	.58	29	3.1	.71	.83
#4.0	30	37	4.0	.56	.65	26	2.8	.80	.93
	40	39	4.5	.57	.66	27	3.2	.81	.94
	50	39	5.2	.66	.76	27	3.6	.94	1.09
	60	40	5.6	.67	.78	28	3.9	.96	1.11
#5.0	30	37	4.8	.68	.78	26	3.4	.97	1.11
	40	38	5.6	.75	.86	27	3.9	1.07	1.23
	50	41	6.5	.74	.86	29	4.6	1.06	1.23
	60	43	7.2	.75	.87	30	5.0	1.07	1.24
#6.0	30	40	6.0	.72	.83	28	4.2	1.03	1.19
	40	41	6.8	.78	.90	29	4.8	1.11	1.29
	50	42	7.5	.82	.95	29	5.3	1.17	1.36
	60	44	8.4	.84	.96	31	5.9	1.20	1.37
#8.0	30	38	7.9	1.05	1.22	27	5.5	1.50	1.74
	40	44	9.2	.92	1.06	31	6.4	1.31	1.51
	50	45	10.4	.99	1.14	32	7.3	1.41	1.63
	60	46	11.1	1.01	1.17	32	7.8	1.44	1.67

Low Angle Performance Data

NOZZLE	PRESSURE PSI	NO ADJUSTMENT				-30% ADJUSTMENT			
		RADIUS Feet	FLOW GPM	PRECIP in/hr ■ ▲		RADIUS Feet	FLOW GPM	PRECIP in/hr ■ ▲	
#1.0	30	26	1.1	.31	.36	18	0.8	.44	.51
	40	30	1.3	.28	.32	21	0.9	.40	.46
	50	30	1.4	.30	.35	21	1.0	.43	.50
	60	30	1.6	.34	.40	21	1.1	.49	.57
#1.5	30	27	1.4	.37	.43	19	1.0	.53	.61
	40	28	1.7	.42	.48	20	1.2	.60	.69
	50	31	1.9	.38	.44	22	1.3	.54	.63
	60	30	2.1	.45	.52	21	1.5	.64	.74
#2.0	30	30	2.1	.45	.52	21	1.5	.64	.74
	40	31	2.4	.48	.56	22	1.7	.69	.80
	50	33	2.8	.50	.57	23	2.0	.71	.81
	60	31	3.1	.62	.72	22	2.2	.89	1.03
#3.0	30	32	3.0	.56	.65	22	2.1	.80	.93
	40	34	3.5	.58	.67	24	2.5	.83	.96
	50	35	3.9	.61	.71	25	2.7	.87	1.01
	60	35	4.3	.68	.78	25	3.0	.97	1.11

*All precipitation rates calculated for 180° operation.
For the precipitation rate for a 360° sprinkler, divide by 2.

Easy Arc Setting

Arc selection from 40° to continuous 360°. Adjust from left start.

- Reduces distance and flow rate simultaneously and proportionately

- Provides full on/off control

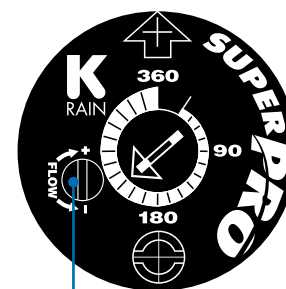

Intelligent Flow Technology®

How to Specify with Options

MODEL	OPTION
10003	-CV Check valve
10003-HP	-NN No nozzle
10003-SH	-RCW Reclaimed water use
	-OS On-site wastewater applications

Examples: 10003-RCW-CV

Accessories

See page 24-25

Performance Data, Metric

NOZZLE	NO ADJUSTMENT						-30% ADJUSTMENT			
	PRESSURE		RADIUS	FLOW	PRECIP mm/hr		RADIUS	FLOW	PRECIP mm/hr	
	kPa	Bar	Meters	L/M	■	▲	Meters	L/M	■	▲
#1.0	207	2,1	10,1	4,5	5	6	6,4	3,2	8	9
	276	2,8	10,1	4,9	6	7	6,6	3,4	8	10
	345	3,4	10,1	5,7	7	8	6,6	4,0	10	11
	414	4,1	10,1	6,8	8	9	6,8	4,8	12	13
#1.5	207	2,1	11,0	5,7	6	7	7,7	4,0	8	9
	276	2,8	11,3	6,8	6	7	7,9	4,8	9	11
	345	3,4	11,3	7,6	7	8	7,9	5,3	10	12
	414	4,1	11,6	8,3	7	9	8,1	5,8	11	12
#2.0	207	2,1	10,7	6,8	7	8	7,5	4,8	10	12
	276	2,8	10,7	8,3	9	10	7,5	5,8	13	15
	345	3,4	11,0	9,8	10	11	7,7	6,9	14	16
	414	4,1	11,6	11,0	10	11	8,1	7,7	14	16
#2.5 Pre- installed	207	2,1	11,3	9,5	9	10	7,9	6,6	13	15
	276	2,8	11,6	11,4	10	12	8,1	8,0	15	17
	345	3,4	12,2	12,9	10	12	8,5	9,0	15	17
	414	4,1	12,2	14,4	12	13	8,5	10,1	17	19
#3.0	207	2,1	11,0	11,4	11	13	7,7	8,0	16	19
	276	2,8	11,3	12,9	12	14	7,9	9,0	17	20
	345	3,4	11,6	15,1	13	16	8,1	10,6	19	22
	414	4,1	12,5	16,7	13	15	8,8	11,7	18	21
#4.0	207	2,1	11,3	15,1	14	17	7,9	10,6	20	24
	276	2,8	11,9	17,0	14	17	8,3	11,9	21	24
	345	3,4	11,9	19,7	17	19	8,3	13,8	24	28
	414	4,1	12,2	21,2	17	20	8,5	14,9	24	28
#5.0	207	2,1	11,3	18,2	17	20	7,9	12,7	25	28
	276	2,8	11,6	21,2	19	22	8,1	14,9	27	31
	345	3,4	12,5	24,6	19	22	8,8	17,2	27	31
	414	4,1	13,1	27,3	19	22	9,2	19,1	27	32
#6.0	207	2,1	12,2	22,7	18	21	8,5	15,9	26	30
	276	2,8	12,5	25,7	20	23	8,8	18,0	28	33
	345	3,4	12,8	28,4	21	24	9,0	19,9	30	34
	414	4,1	13,4	31,8	21	24	9,4	22,3	30	35
#8.0	207	2,1	11,6	29,9	27	31	8,1	21,0	38	44
	276	2,8	13,4	34,8	23	27	9,4	24,4	33	38
	345	3,4	13,7	39,4	25	29	9,6	27,6	36	41
	414	4,1	14,0	42,0	26	30	9,8	29,4	37	42

Low Angle Performance Data, Metric

NOZZLE	NO ADJUSTMENT						-30% ADJUSTMENT			
	PRESSURE		RADIUS	FLOW	PRECIP mm/hr		RADIUS	FLOW	PRECIP mm/hr	
	kPa	Bar	Meters	L/M	■	▲	Meters	L/M	■	▲
#1.0	207	2,1	7,9	4,2	8	9	5,6	2,9	11	13
	276	2,8	9,1	4,9	7	8	6,4	3,4	10	12
	345	3,4	9,1	5,3	8	9	6,4	3,7	11	13
	414	4,1	9,1	6,1	9	10	6,4	4,2	12	15
#1.5	207	2,1	8,2	5,3	9	11	5,8	3,7	13	16
	276	2,8	8,5	6,4	11	12	6,0	4,5	15	17
	345	3,4	9,4	7,2	10	11	6,6	5,0	14	16
	414	4,1	9,1	7,9	11	13	6,4	5,6	16	19
#2.0	207	2,1	9,1	7,9	11	13	6,4	5,6	16	19
	276	2,8	9,4	9,1	12	14	6,6	6,4	17	20
	345	3,4	10,1	10,6	13	14	7,0	7,4	18	21
	414	4,1	9,4	11,7	16	18	6,6	8,2	22	26
#3.0	207	2,1	9,8	11,4	14	17	6,8	8,0	20	24
	276	2,8	10,4	13,2	15	17	7,3	9,3	21	24
	345	3,4	10,7	14,8	15	18	7,5	10,3	22	26
	414	4,1	10,7	16,3	17	20	7,5	11,4	25	28

*All precipitation rates calculated for 180° operation.

For the precipitation rate for a 360° sprinkler, divide by 2.





Watch the video. Scan this code with your smartphone camera.



ProSport®

Designed for sports turf and commercial applications.

Features

- Patented Top Arc Set – Allows for wet or dry adjustment in seconds
- Triple Nozzle Configuration – Ensures even distribution of water
- Arc adjustment from 40° to a continuous 360°
- Top Arc Set Degree Markings – Clearly indicates the current watering pattern and simplifies arc set adjustment
- Arc Memory Clutch – Prevents internal gear damage and returns rotor to its prior setting automatically if nozzle turret is forced past stop
- Patented Reversing Mechanism – Assures continuous reverse and return
- Heavy Duty Rubber Cover and Mud Guard – Protects against physical injury and allows sprinkler to be installed below grade
- Factory Installed Check Valve – Prevents low head drainage

Specifications

- Arc Adjustment Range: 40° to Continuous 360°
- Flow Range: 5.1 – 32.5 GPM (19,3 – 123 LPM)
- Pressure Rating: 40 – 90 PSI (2,8 – 6,2 bar)
- Precipitation Rate: .48 – 1.56 in/hr (12,2 – 39,6 mm/hr) (depending on spacing and nozzle used)
- Recommended Spacing: 40' – 65' (12,2 – 19,8 m)
- Radius: 43' – 77' (13,1 – 23,5 m)
- Nozzle Trajectory: 26°

Model

- 14003** ProSport® Plastic
- 14003-6INCH** ProSport® 6 inch
- 14053** ProSport® High Speed Plastic

Easy Arc Setting

Arc Selection: 40° to continuous 360°
Adjust from left start



Accessories







See page 24-25

Fast Facts







ALL	Inlet: 1" (2,5 cm) female thread NPT
4"	Retracted height: 7 1/2" (19 cm) Riser height: 4 1/2" (11,4 cm)
6"	Retracted height: 12" (30,5 cm) Riser height: 6 1/4" (15,9 cm)









14003 Performance Data

NOZZLE	PRESSURE PSI	RADIUS Feet	FLOW GPM	PRECIP in/hr	
				■	▲
	40	45	5.1	.48	.58
	50	47	5.9	.51	.62
	60	47	6.5	.57	.68
	70	49	7.1	.57	.68
	50	53	10.6	.73	.87
	60	53	11.8	.81	.97
	70	53	12.6	.86	1.04
	80	55	13.5	.86	1.03
	50	57	13.0	.77	.92
	60	59	14.2	.79	.94
	70	59	15.4	.85	1.02
	80	63	16.5	.80	.96
	60	65	18.9	.86	1.03
	70	67	20.5	.88	1.06
	80	69	21.9	.89	1.06
	90	71	23.2	.89	1.06
	60	67	22.8	.98	1.17
	70	71	24.8	.95	1.14
	80	75	26.5	.91	1.09
	90	77	26.8	.87	1.04
	60	67	23.7	1.02	1.22
	70	69	25.6	1.04	1.24
	80	69	27.5	1.11	1.33
	90	71	29.2	1.12	1.34







14003 Performance Data, Metric

NOZZLE	PRESSURE Bar	RADIUS Meters	FLOW L/M	PRECIP mm/hr	
				■	▲
	2,8	13,7	19,3	12	15
	3,5	14,3	22,3	13	16
	4,1	14,3	24,6	14	17
	4,8	14,9	26,9	14	17
	3,5	16,2	40,1	18	22
	4,1	15,9	44,7	21	25
	4,8	16,2	47,7	22	26
	5,5	16,8	51,1	22	26
	3,5	17,4	49,2	20	23
	4,1	18,0	53,8	20	24
	4,8	18,0	58,3	22	26
	5,5	19,2	62,5	20	24
	4,1	19,8	71,5	22	26
	4,8	20,4	77,6	22	27
	5,5	21,0	82,9	23	27
	6,2	21,6	87,8	23	27
	4,1	20,4	86,3	25	30
	4,8	21,6	93,9	24	29
	5,5	22,9	100,3	23	28
	6,2	23,5	101,4	22	26
	4,1	20,4	89,7	26	31
	4,8	21,0	96,9	26	31
	6,2	21,0	104,1	28	34
	6,2	21,6	110,5	28	34

14053 Performance Data

NOZZLE	PRESSURE PSI	RADIUS Feet	FLOW GPM	PRECIP in/hr	
				■	▲
	40	43	5.9	.61	.71
	50	44	6.2	.62	.71
	60	45	6.4	.61	.70
	70	45	7.6	.72	.83
	50	49	10.6	.85	.98
	60	53	11.5	.79	.91
	70	53	13.3	.91	1.05
	80	54	14.0	.92	1.07
	50	52	12.4	.88	1.02
	60	54	13.6	.90	1.04
	70	56	14.6	.90	1.03
	80	58	15.9	.91	1.05
	60	56	19.8	1.22	1.40
	70	58	21.2	1.21	1.40
	80	59	22.8	1.26	1.46
	90	60	24.4	1.30	1.51
	60	59	22.4	1.24	1.43
	70	66	25.7	1.14	1.31
	80	67	27.8	1.19	1.38
	90	68	29.9	1.24	1.44
	60	60	25.2	1.35	1.56
	70	72	28.5	1.06	1.22
	80	73	30.8	1.11	1.28
	90	75	32.5	1.11	1.28

14053 Performance Data, Metric

NOZZLE	PRESSURE Bar	RADIUS Meters	FLOW L/M	PRECIP mm/hr	
				■	▲
	2,8	13,1	22,3	15	18
	3,5	13,4	23,5	16	18
	4,1	13,7	24,2	15	18
	4,8	13,7	28,8	18	21
	3,5	14,9	40,1	22	25
	4,1	15,8	44,3	20	23
	4,8	16,1	50,3	23	27
	5,5	16,5	53,0	23	27
	3,5	15,8	46,9	22	26
	4,1	16,5	55,3	23	26
	4,8	17,1	58,7	23	26
	5,5	17,1	60,2	23	27
	4,1	17,1	66,2	31	36
	4,8	17,7	71,5	31	36
	5,5	18,0	78,7	32	37
	6,2	18,3	82,1	33	38
	4,1	18,0	84,8	31	36
	4,8	20,1	97,3	29	33
	5,5	20,4	105,2	30	35
	6,2	20,7	113,2	31	37
	4,1	18,3	95,4	34	40
	4,8	22,0	107,9	27	31
	6,2	22,2	116,6	28	33
	6,2	22,9	123,0	28	33

*All precipitation rates calculated for 180° operation. For the precipitation rate for a 360° sprinkler, divide by 2.

How to Specify with Options

MODEL	OPTION
14003	-SS Stainless steel
14003-6INCH	-BSP with BSP thread
14053	-RCW Reclaimed water use

Examples: 14003-BSP, 14053-RCW-NN

Visit our
Sport Field
Designs.



Rotor Accessories

Nozzle Racks

- P52775** MiniPro® and RPS 50 Nozzle Rack (red)
- P51399** ProPlus® Nozzle Rack (red)
Standard: 0.5, 0.75, 1, 2, 3, 4, 6, 8 GPM
Low Angle: 1, 3, 4, 6 GPM
Pre-installed Nozzle: 2.5 GPM
- P16001101** RPS™ 75 Nozzle Rack (red)
Standard: 0.75, 1, 1.5, 2, 4, 6, 8 GPM
Low Angle: 1, 3, 4, 6 GPM
Pre-installed Nozzle: 3.0 GPM
- P90001102** ProPlus-RCW low angle nozzle rack
- P16001110** RPS™ 75i, SuperPro Nozzle Rack (green)
Standard: 1, 1.5, 2, 2.5, 3, 4, 5, 6, 8 GPM
Low Angle: 1, 1.5, 2, 3 GPM
Pre-installed Nozzle: 2.5 GPM

ProSport®

- P55519** 5 GPM (18,9 LPM), white
10 GPM (37,9 LPM), green
15 GPM (56,8 LPM), grey
20 GPM (75,7 LPM), brown
25 GPM (94,6 LPM), blue
30 GPM (113,5 LPM), black

How to Specify Nozzle

MODEL	OPTION
55519	-5

Example: 55519-5

Adjustment Tools

- P59995** K-Key; MiniPro®, ProPlus® Adjustment Key
- P1000902** SuperPro®, RPS™ Select, ProSport® Adjustment Key
- P1000901** RPS™ 75, RPS™ 75i, RPS™ 50 Adjustment Key
- RN-ADJ-TOOL** Rotary Nozzle Adjustment Tool

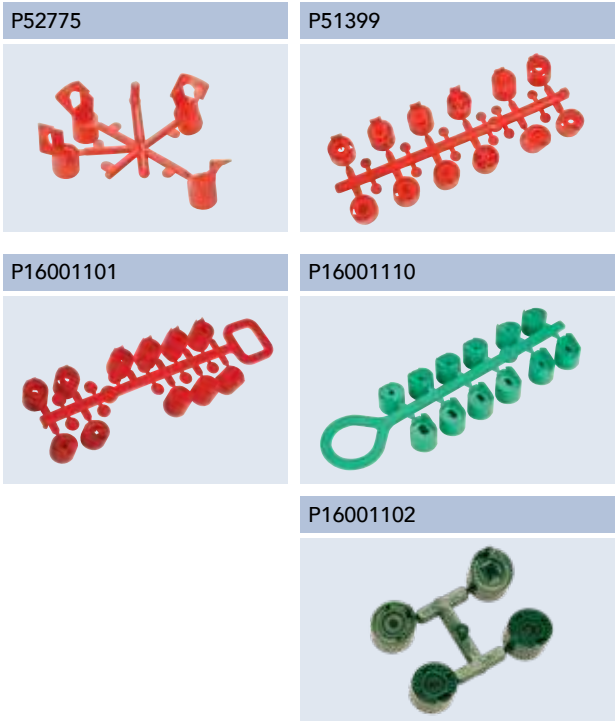

Riser Clips, Check Valves and Filter Baskets

P54065	Riser Clip
P51210	SuperPro®-HP, SuperPro®-SH, RPS™ Select-SH, RPS™ 75-SH, RPS™ 75i-SH, ProPlus® High Pop and ProPlus® Shrub Check Valve*
P513995	MiniPro®, RPS™ 50 Check Valve
P16009110	RPS™ 75, 75i, Select, ProPlus®, SuperPro® Check Valve Assembly
P53425	ProSport® Check Valve*
P51114	MiniPro® Filter Basket
P51115	RPS™ 75, 75i, Select Filter Basket
P51112	SuperPro® High Pop, ProPlus® High Pop Filter Basket*
P58115	ProPlus®, SuperPro® Filter Basket

*Also for use with ProPlus® and SuperPro® rotors in-ground before October 2019.

Swing Pipe & Fittings

KA05100	Swing Pipe, 1/2" x 100' Roll
SWPC050	Swing Pipe, Coupling, 1/2" Barb
SWPT050	Swing Pipe, Tee, 1/2" Barb
SWPE050	Swing Pipe, Elbow, 1/2" MNPT x 1/2" Barb
SWPE075	Swing Pipe, Elbow, 3/4" MNPT x 1/2" Barb
SWPA060505	Swing Pipe Assembly, 6in, 1/2" Inlet x 1/2" Outlet
SWPA120505	Swing Pipe Assembly, 12in, 1/2" Inlet x 1/2" Outlet
SWPA127575	Swing Pipe Assembly, 12in, 3/4" Inlet x 3/4" Outlet
SWPA180505	Swing Pipe Assembly, 18in, 1/2" Inlet x 1/2" Outlet

KA05100

SWPC050

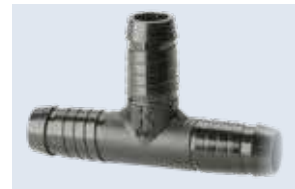
SWPT050

SWPE050

SWPE075

SWPA127575

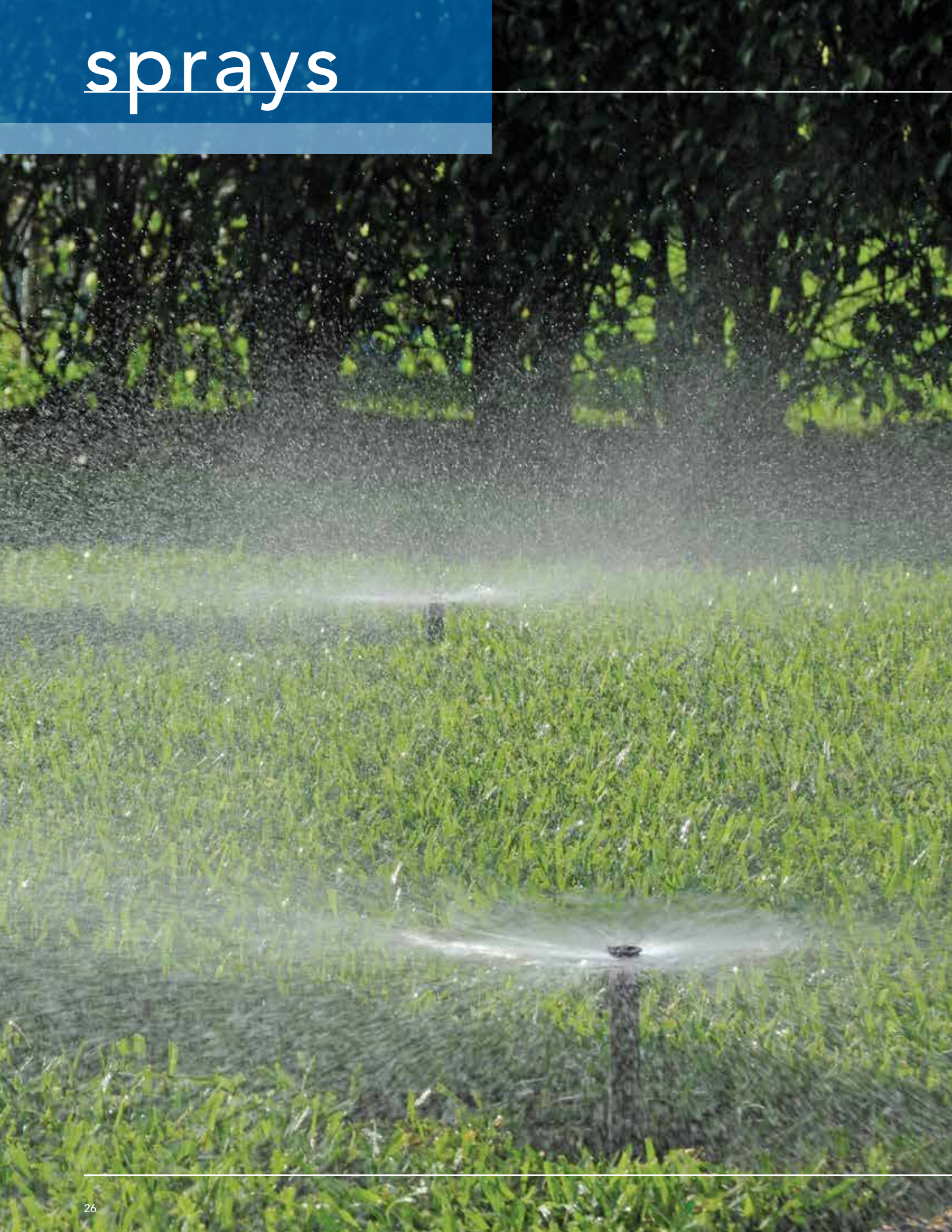
sprays



Spray Body Comparison Chart

The perfect combination of precise engineering and extensive field testing ensures long life and outstanding performance with every K-Rain spray. Well-suited for any application, the sprays are rugged, reliable and available in a wide selection of sizes for optimal flexibility.

Model	PRO-S SPRAYS					NP SPRAYS		K-SPRAYS			
	78002	78003	78004	78006	78012	NP2	NP4	73001	74001	76001	71201
Specifications											
Pop-up height	1 1/2"	2 1/2"	3 1/2"	5 1/2"	11 1/2"	2"	3 7/8"	2 1/2"	4"	5 7/8"	11 1/2"
Retracted height	4 3/8"	5"	6"	9 3/8"	16"	4"	6"	4 3/4"	5 7/8"	8"	15 3/4"
Pressure range (PSI)	20-70	20-70	20-70	20-70	20-70	20-70	20-70	20-70	20-70	20-70	20-70
Inlet	1/2" female thread	1/2" female thread	1/2" female thread	1/2" female thread	1/2" female thread	1/2" female thread	1/2" female thread	1/2" female thread	1/2" female thread	1/2" female thread	1/2" female thread
Nozzle	female threaded	female threaded	female threaded	female threaded	female threaded	female threaded	female threaded	male threaded	male threaded	male threaded	male threaded
Features											
Co-molded wiper seal	•	•	•	•	•						
Ratcheting riser	•	•	•	•	•	•	•	•	•	•	•
Heavy duty retraction spring	•	•	•	•	•	•	•	•	•	•	•
Side inlet				★	•						•
Narrow profile						•	•				
Warranty	5 years	5 years	5 years	5 years	5 years	5 years	5 years	5 years	5 years	5 years	5 years
Options											
Check valve	•	•	•	•	•	•	•	•	•	•	•
Nozzle guard	•	•	•	•	•						
Pressure regulator (30 PSI)			•	•	•						
Pressure regulator (40 PSI)			•	•	•						
Reclaimed water use	•	•	•	•	•			•	•	•	•
Stop Flow™			•	•	•						

*No side inlet option available.

PRO-S™ Sprays

Proven long life and outstanding performance.

sprays

Features

- Co-molded wiper seal — Ensures a leak-free, full pop-up even under low pressure situations. Treated with UV inhibitors for long life. Carefully selected seal material reduces degradation and stick-ups
- Heavy-duty retraction spring — Strongest in the industry for complete retraction in all soil conditions
- Pre-installed flush cap
- Accepts female threaded nozzles
- Fits in Rain Bird® 1800 can

Specifications

- Pressure rating: 20 – 70 PSI (1,4 – 4,8 bar)
- Flow-by: 0 – 8 PSI (0,6 bar) 0.20 GPM (0,76 LPM)
- Inlet: 1/2" (1,3 cm) Female Thread NPT

Models

- 78002** Pro-S 2" (5 cm) Pop-up
- 78003** Pro-S 3" (7,5 cm) Pop-up
- 78004** Pro-S 4" (10 cm) Pop-up
- 78006** Pro-S 6" (15 cm) Pop-up with side inlet
- 78012** Pro-S 12" (30 cm) Pop-up

Accessories

See page 32

Fast Facts

All	Inlet: 1/2" (1,3 cm) female thread NPT
2"	Retracted height: 4 3/8" (11,1 cm) Riser height: 1 1/2" (3,8 cm)
3"	Retracted height: 5" (12,7 cm) Riser height: 2 1/2" (6,4 cm)
4"	Retracted height: 6" (15,2) Riser height: 3 1/2" (8,9 cm)
6"	Retracted height: 9 3/8" (23,8 cm) Riser height: 5 1/2" (14,0 cm)
12"	Retracted height: 16" (40,6 cm) Riser height: 11 1/2" (29,2 cm)



Options

■ In-stem Pressure Regulator

Factory preset at 30 or 40 PSI (2,1 or 2,8 bar). Available in 4", 6" and 12". EPA WaterSense certified. Visit krain.com/watersense-certified for a full list.



■ In-stem Check Valve

Pre-installed or installs in the field. Holds up to 10' (3 m) of head pressure.



■ Pre-installed Nozzle Guard

Protects the nozzle from foot traffic, mowers, edgers and arc changes.

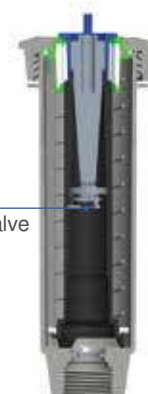

■ Stop Flow™

Automatically stops water flow should the nozzle become damaged or removed.

Stop Flow™ valve

How to Specify with Options

MODEL	OPTION	
78002	- CV	Check valve
78003	- GUARD	Nozzle guard
78004	- NSI	No side inlet (6" only)
78006	- PR30	Pressure regulator 30 PSI
78012	- PR40	Pressure regulator 40 PSI
	- RCW	Reclaimed water use
	- SF	Stop Flow™

Examples: 78004-CV, 78006-NSI-RCW, 78012-CV-PR30



Watch the video. Scan this code with your smartphone camera.

NP Sprays

Ideal for watering smaller lawns, ground cover and shrub areas.

Features

- Available in 2" and 4" (5 cm and 10 cm) Models – Provides flexibility in system design
- Accepts Female Threaded Nozzles
- Stainless Steel Retraction Spring – Provides reliable retraction of the riser in all soil conditions
- Ratcheting Riser – Allows for easy pattern alignment by turning the riser
- Narrow Profile Body – Easy to retrofit with existing systems

Specifications

- Pressure Rating: 20 – 70 PSI (1,4 – 4,8 bar)
- Inlet: 1/2" (1,3 cm) female thread NPT

Models

- NP2** 2" (5 cm) Narrow Profile Spray Body
- NP4** 4" (10 cm) Narrow Profile Spray Body

Fast Facts

All	Inlet: 1/2" (1,3 cm) female thread NPT
NP2	Retracted height: 4" (10,2 cm) Riser height: 2" (5,1 cm)
NP4	Retracted height: 6" (15,2 cm) Riser height: 3 7/8" (9,8 cm)

How to Specify with Options

MODEL	OPTION
NP2	-CV Check valve
NP4	

Example: NP4-CV

Accessories

See page 32



A wide range of pop-up heights suited for many applications.

www.krain.com

sprays

Features

- Available in 3", 4", 6" and 12" Models – Provides flexibility in system design
- Accepts Male Threaded Nozzles
- Stainless Steel Retraction Spring – Provides reliable retraction of the riser in all soil conditions
- Ratcheting Riser – Allows for easy pattern alignment by turning the riser
- Heavy Duty Wiper Seal – Ensures leak free, full pop-up operation even under low-pressure situations
- Optional Water-Saving Check Valve – Eliminates low head drainage
- Optional Purple Cap for Reclaimed Water Use – Highly visible for identification of RCW systems

Fast Facts

All	Inlet: 1/2" (1,3 cm) female thread NPT
73001	Retracted height: 4 3/4" (12,1 cm) Riser height: 2 1/2" (6,4 cm)
74001	Retracted height: 5 7/8" (14,9 cm) Riser height: 4" (10,2 cm)
76001	Retracted height: 8" (20,3 cm) Riser height: 5 7/8" (14,9 cm)
71201	Retracted height: 15 3/4" (40 cm) Riser height: 11 1/2" (29,2 cm)

Specifications

- Pressure Rating: 20 – 70 PSI (1,4 – 4,8 bar)
- Inlet: 1/2" (1,3 cm) female thread NPT

Models

- 73001 3" (7,6 cm) Pop-Up
- 74001 4" (10 cm) Pop-Up
- 76001 6" (15 cm) Pop-Up
- 71201 12" (30,5 cm) Pop-Up

How to Specify with Options

MODEL	OPTION
73001	-CV Check valve
74001	-RCW Reclaimed water use
76001	
71201	

Examples: 73001-CV, 71201-RCW

Accessories

See page 32



Spray Accessories

Models

SHRUB ADAPTERS

- PSA** Shrub Adapter, Female Thread (for male nozzles)
- PFSA** Shrub Adapter, Male Thread (for female nozzles)
- PSA-RCW** RCW Shrub adapter, Female Thread, (for male nozzles)
- PFSA-RCW** RCW Shrub adapter, Male Thread, (for female nozzles)



Models

CHECK DISKS

- P53426** K-Spray™ Check Valve
- P53428** Pro-S™ Check Valve
- P53429** NP Spray™ Check Valve



Models

NOZZLE GUARD

- 78000** Nozzle Guard
(fits Pro-S™ Sprays)
- 78000-RCW** Nozzle Guard for Reclaimed Water*
(Does not include riser seal)



Models

SWING PIPE & FITTINGS

- KA05100** Swing Pipe, 1/2" x 100' Roll
- SWPC050** Swing Pipe, Coupling, 1/2" Barb
- SWPT050** Swing Pipe, Tee, 1/2" Barb
- SWPE050** Swing Pipe, Elbow, 1/2" MNPT x 1/2" Barb
- SWPE075** Swing Pipe, Elbow, 3/4" MNPT x 1/2" Barb
- SWPA060505** Swing Pipe Assembly, 6in,
1/2" Inlet x 1/2" Outlet
- SWPA120505** Swing Pipe Assembly, 12in,
1/2" Inlet x 1/2" Outlet
- SWPA127575** Swing Pipe Assembly, 12in,
3/4" Inlet x 3/4" Outlet
- SWPA180505** Swing Pipe Assembly, 18in,
1/2" Inlet x 1/2" Outlet

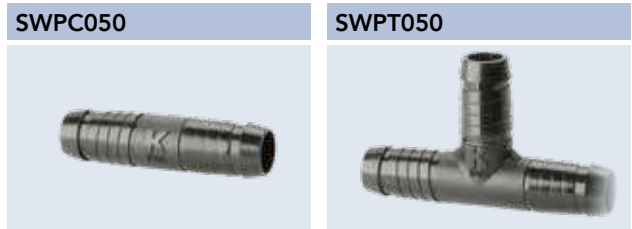

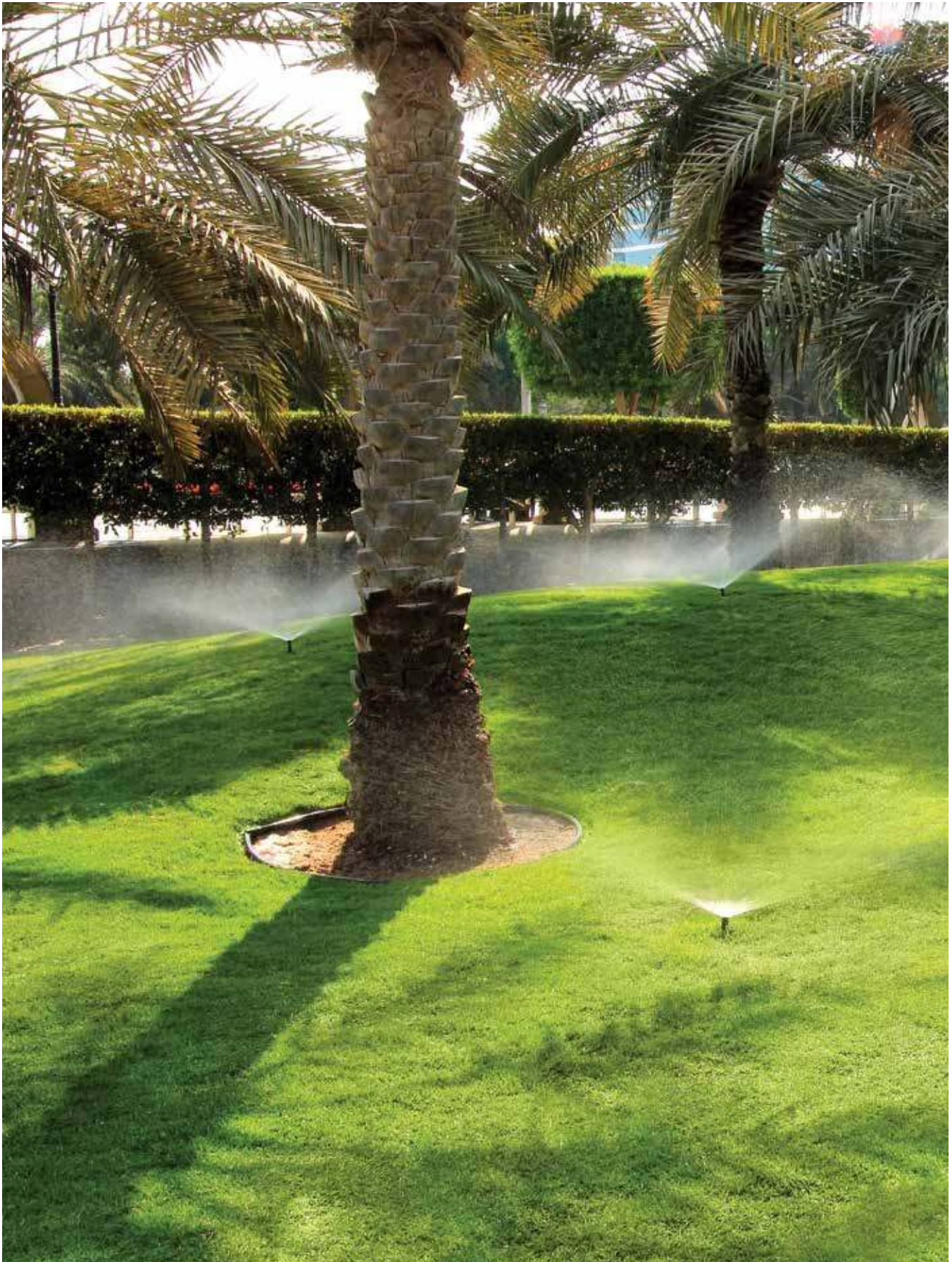

nozzles



Nozzle Comparison Chart

Designed with the utmost attention to detail, the versatility of the K-Rain nozzle line ensures that the professional has everything needed for a variety of residential and commercial terrains.

	Rotary Nozzle Series	Fully Adjustable Rotary Nozzle	HE KVF Adjustable Nozzles	KV Adjustable Nozzles	Fixed Pattern Nozzles
Nozzle Type	Full 360° Adjustable	Fully Adjustable	High Efficiency, Fully Adjustable	Fully Adjustable	Fixed Spray
Specifications					
Arc	90° - 360°	80° - 360°	0° - 360°	0° - 360°	90° - 360°
Radius	13' - 30'	13' - 30'	8' - 18'	5' - 20'	6' - 17'
Thread	female	female	female	male	female & male
Special patterns	right, left & side strip				center, end, side & high/low strip
Special pattern dimensions	4' x 15' to 7' x 32'				4' x 12' to 15' x 5' x 32'
Features					
Color-coded	•	•	•	•	•
Automatic matched precipitation	•	•	•	•	
Warranty	2 year	2 year	2 year	2 year	2 year

* At optimal pressure

Rotary Nozzle Series

Superior uniformity for demanding, low-precipitation applications.

Features

- **Durable Design** – Molded with high-impact engineered resin for long life
- **Superior Uniformity** – Multi-stream technology provides outstanding coverage eliminating brown spots
- **Matched Precipitation** – Low precipitation rate is proportionate even after arc and radius adjustment
- **Water-smart Technology** – Reduce water usage up to 30% without compromising on results
- **Double pop-up Design** – Delivers additional protection from dirt/particulate intrusion in all conditions
- **Simple to Adjust** – Easiest adjustment in the industry
- **Color-Coded** – Easily identify 6 standard nozzles and 3 specialty nozzles in the field

Watch the video.
Scan this code
with your smart-
phone camera.



Models

RN100 ADJ-90-270

90°-270° Adjustable
3' – 15' (4 – 4,6 m)

■ **Medium Green**

RN100 FIX 360

360° Fixed Pattern,
13' – 15' (4 – 4,6 m)

■ **Light Green**

RN200 ADJ-90-270

90°-270° Adjustable,
16' – 19' (4,9 – 5,8 m)

■ **Medium Blue**

RN200 FIX 360

360° Fixed Pattern,
16' – 19' (4,9 – 5,8 m)

■ **Light Blue**

RN300 ADJ-90-270

90°-270° Adjustable,
26' – 30' (7,9 – 8,2 m)

■ **Medium Grey**

RN300 FIX 360

360° Fixed Pattern,
26' – 30' (7,9 – 9,1 m)

■ **Light Grey**

RNS-RES-515

Right End Strip,

■ **Burnt Orange**

RNS-LES-515

Left End Strip,

■ **Olive**

RNS-SS-530

Side Strip,

■ **Brown**

Performance Data

RN100-ADJ-90-270 (medium green)

ARC DEGREE	PRESSURE PSI	RADIUS Feet	FLOW GPM	PRECIP in/hr	
				■	▲
90°	30	13	.22	.50	.58
	35	14	.24	.47	.54
	40	14	.25	.49	.57
	45	15	.28	.48	.55
	50	15	.30	.51	.59
180°	30	13	.44	.50	.58
	35	14	.47	.46	.53
	40	14	.50	.49	.57
	45	15	.58	.50	.57
	50	15	.60	.51	.59
270°	30	13	.66	.50	.58
	35	14	.71	.46	.54
	40	14	.75	.49	.57
	45	15	.88	.50	.58
	50	15	.90	.51	.59

Performance Data

RN100-FIX360 (light green)

ARC DEGREE	PRESSURE PSI	RADIUS Feet	FLOW GPM	PRECIP in/hr	
				■	▲
360°	30	13	.88	.50	.58
	35	14	.94	.46	.53
	40	14	1.00	.49	.57
	45	15	1.15	.49	.57
	50	15	1.20	.51	.59

Performance Data

RN200-ADJ-90-270 (medium blue)

ARC DEGREE	PRESSURE PSI	RADIUS Feet	FLOW GPM	PRECIP in/hr	
				■	▲
90°	30	16	.34	.51	.59
	35	17	.38	.51	.58
	40	18	.41	.49	.56
	45	19	.42	.45	.52
	50	19	.47	.50	.58
180°	30	16	.67	.50	.58
	35	17	.75	.50	.58
	40	18	.83	.49	.57
	45	19	.84	.45	.52
	50	19	.94	.50	.58
270°	30	16	1.01	.51	.58
	35	17	1.13	.50	.58
	40	18	1.24	.49	.57
	45	18	1.26	.50	.58
	50	19	1.41	.50	.58

Performance Data

RN200-FIX360 (light blue)

ARC DEGREE	PRESSURE PSI	RADIUS Feet	FLOW GPM	PRECIP in/hr	
				■	▲
360°	30	16	1.34	.50	.58
	35	17	1.50	.50	.58
	40	18	1.65	.49	.57
	45	19	1.68	.45	.52
	50	19	1.88	.50	.58

Performance Data, Metric

RN100-ADJ-90-270 (medium green)

ARC DEGREE	PRESSURE Bar	RADIUS Meters	FLOW L/M	PRECIP mm/hr	
				■	▲
90°	2,1	3,97	0,83	13	15
	2,4	4,27	0,91	12	14
	2,8	4,27	0,95	12	14
	3,1	4,58	1,06	12	14
	3,5	4,58	1,14	13	15
180°	2,1	3,97	1,67	13	15
	2,4	4,27	1,78	12	13
	2,8	4,27	1,89	12	14
	3,1	4,58	2,20	13	15
	3,5	4,58	2,27	13	15
270°	2,1	3,97	2,50	13	15
	2,4	4,27	2,69	12	14
	2,8	4,27	2,84	12	14
	3,1	4,58	3,33	13	15
	3,5	4,58	3,41	13	15

Performance Data, Metric

RN100-FIX360 (light green)

ARC DEGREE	PRESSURE Bar	RADIUS Meters	FLOW L/M	PRECIP mm/hr	
				■	▲
360°	2,1	3,97	3,33	13	15
	2,4	4,27	3,56	12	14
	2,8	4,27	3,79	12	14
	3,1	4,58	4,35	12	14
	3,5	4,58	4,54	13	15

Performance Data, Metric

RN200-ADJ-90-270 (medium blue)

ARC DEGREE	PRESSURE Bar	RADIUS Meters	FLOW L/M	PRECIP mm/hr	
				■	▲
90°	2,1	4,88	1,29	13	15
	2,4	5,19	1,44	13	15
	2,8	5,49	1,55	12	14
	3,1	5,80	1,59	11	13
	3,5	5,80	1,78	13	15
180°	2,1	4,88	2,54	13	15
	2,4	5,19	2,84	13	15
	2,8	5,49	3,14	12	14
	3,1	5,80	3,18	11	13
	3,5	5,80	3,56	13	15
270°	2,1	4,88	3,82	13	15
	2,4	5,19	4,28	13	15
	2,8	5,49	4,69	12	14
	3,1	5,49	4,77	13	15
	3,5	5,80	5,34	13	15

Performance Data, Metric

RN200-FIX360 (light blue)

ARC DEGREE	PRESSURE Bar	RADIUS Meters	FLOW L/M	PRECIP mm/hr	
				■	▲
360°	2,1	4,88	5,07	13	15
	2,4	5,19	5,68	13	15
	2,8	5,49	6,25	12	14
	3,1	5,80	6,36	11	13
	3,5	5,80	7,12	13	15

*Data represents test results in zero wind. Adjust for local conditions.

Performance Data

RN300-ADJ-90-270 (medium grey)

ARC DEGREE	PRESSURE PSI	RADIUS Feet	FLOW GPM	PRECIP in/hr	
				■	▲
90°	30	26	.80	.46	.53
	35	26	.85	.48	.56
	40	27	.90	.48	.55
	45	28	.95	.47	.54
	50	28	1.00	.49	.57
180°	30	26	1.40	.40	.46
	35	27	1.50	.40	.46
	40	27	1.60	.42	.49
	45	29	1.70	.39	.45
	50	30	1.80	.39	.44
270°	30	26	2.45	.47	.54
	35	27	2.55	.45	.52
	40	28	2.75	.45	.52
	45	28	2.90	.47	.55
	50	27	3.10	.55	.63

Performance Data, Metric

RN300-ADJ-90-270 (medium grey)

ARC DEGREE	PRESSURE Bar	RADIUS Meters	FLOW L/M	PRECIP mm/hr	
				■	▲
90°	2,1	7,93	3,03	12	13
	2,4	7,93	3,22	12	14
	2,8	8,24	3,41	12	14
	3,1	8,54	3,60	12	14
	3,5	8,54	3,79	12	14
180°	2,1	7,93	5,30	10	12
	2,4	8,24	5,68	10	12
	2,8	8,24	6,06	11	12
	3,1	8,85	6,44	10	11
	3,5	9,15	6,81	10	11
270°	2,1	7,93	9,27	13	14
	2,4	8,24	9,65	12	13
	2,8	8,54	10,41	12	13
	3,1	8,54	10,98	13	14
	3,5	8,24	11,73	13	16

Performance Data

RN300-FIX360 (light grey)

ARC DEGREE	PRESSURE PSI	RADIUS Feet	FLOW GPM	PRECIP in/hr	
				■	▲
360°	30	26	3.10	.44	.51
	35	27	3.20	.42	.49
	40	28	3.50	.43	.50
	45	28	3.55	.44	.50
	50	30	3.70	.40	.46

Performance Data, Metric

RN300-FIX360 (light grey)

ARC DEGREE	PRESSURE Bar	RADIUS Meters	FLOW L/M	PRECIP mm/hr	
				■	▲
360°	2,1	7,93	11,73	11	13
	2,4	8,24	12,11	11	12
	2,8	8,54	13,25	11	13
	3,1	8,54	13,44	11	13
	3,5	9,15	14,01	10	12

Performance Data

Special Patterns

PATTERN	NOZZLE	PRESSURE PSI	W X L Feet	FLOW GPM
Right End Strip	RNS-RES-515	30	4 x 15	.30
	Burnt Orange	35	5 x 15	.32
		40	5 x 15	.35
		45	6 x 16	.38
		50	6 x 16	.40
Left End Strip	RNS-LES-515	30	4 x 15	.30
	Olive	35	5 x 15	.32
		40	5 x 15	.35
		45	6 x 15	.38
		50	6 x 16	.40
Side Strip	RNS-SS-530	30	4 x 29	.50
	Brown	35	5 x 30	.55
		40	5 x 30	.60
		45	6 x 31	.65
		50	7 x 32	.70

Performance Data, Metric

Special Patterns

PATTERN	NOZZLE	PRESSURE Bar	W X L Meters	FLOW L/M
Right End Strip	RNS-RES-515	2,1	1,22 x 4,6	1,14
	Burnt Orange	2,4	1,5 x 4,6	1,21
		2,8	1,5 x 4,6	1,32
		3,1	1,8 x 4,9	1,43
		3,5	1,8 x 4,9	1,51
Left End Strip	RNS-LES-515	2,1	1,22 x 4,6	1,14
	Olive	2,4	1,5 x 4,6	1,21
		2,8	1,5 x 4,6	1,32
		3,1	1,8 x 4,6	1,43
		3,5	1,8 x 4,9	1,51
Side Strip	RNS-SS-530	2,1	1,22 x 8,8	1,80
	Brown	2,4	1,5 x 9,1	2,08
		2,8	1,5 x 9,1	2,30
		3,1	1,8 x 9,4	2,46
		3,5	2,1 x 9,7	2,64

*Data represents test results in zero wind. Adjust for local conditions.



nozzles

Fully Adjustable Rotary Nozzle

The only fully adjustable rotary nozzle from 80° – 360°.

Features

- Fully adjustable 80° to 360° – only one SKU per distance
- Female Threaded – replaces all female thread nozzles
- Hand adjustable – no tools needed
- Radius adjustment up to 30% – patented flow control
- Arc adjustment wet or dry – visual left start and right stop
- Double pop up system – superior dirt tolerance
- Three model options – distances from 13' to 30' (3,96 m to 9,14 m)
- Matched precipitation – superior efficiency in water and uniformity through all patterns and distances
- Low precipitation rate – reduces runoff and improves soil absorption
- Low flow rate – allows for more heads per zone, fewer zones
- Viscous dampening – ensures consistent application speed over varying flow rates and pressure ranges
- Multiple stream technology – for improved wind resistance
- Large filter – prolongs product life
- Can be installed in the same zone as rotors
- Two year limited warranty

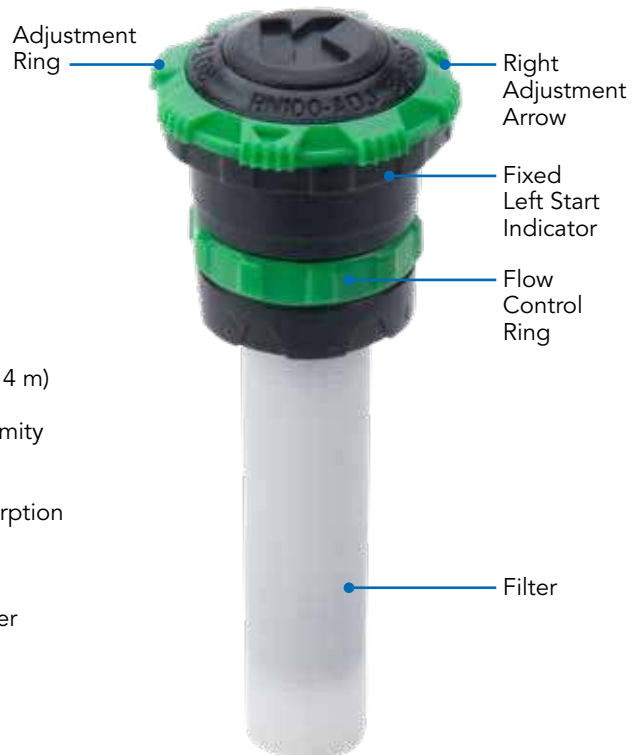

Models

RN100-ADJ

80°-360° Adjustable
13' – 15' (4 – 4,6 m),

 Green

RN200-ADJ

80°-360° Adjustable
16' – 19' (4,9 – 5,8 m),

 Blue

RN300-ADJ

80°-360° Adjustable
26' – 30' (7,9 – 9,1 m),

 Red



Performance Data

RN100-ADJ (green)

ARC DEGREE	PRESSURE PSI	RADIUS Feet	FLOW GPM	PRECIP in/hr	
				■	▲
90°	30	13	.22	.50	.58
	40	14	.25	.49	.57
	50	15	.30	.51	.59
180°	30	13	.44	.50	.58
	40	14	.50	.49	.57
	50	15	.60	.51	.59
360°	30	13	.90	.51	.59
	40	14	1.00	.49	.57
	50	15	1.20	.51	.59

Performance Data, Metric

RN100-ADJ (green)

ARC DEGREE	PRESSURE Bar	RADIUS Meters	FLOW L/M	PRECIP mm/hr	
				■	▲
90°	2,1	3,96	0,83	13	15
	2,8	4,27	0,95	12	14
	3,5	4,57	1,14	13	15
180°	2,1	3,96	1,67	13	15
	2,8	4,27	1,89	12	14
	3,5	4,57	2,27	13	15
360°	2,1	3,96	3,41	13	15
	2,8	4,27	3,79	12	14
	3,5	4,57	4,54	13	15

Performance Data

RN200-ADJ (blue)

ARC DEGREE	PRESSURE PSI	RADIUS Feet	FLOW GPM	PRECIP in/hr	
				■	▲
90°	30	16	.34	.51	.59
	40	18	.41	.49	.56
	50	19	.47	.50	.58
180°	30	16	.67	.50	.58
	40	18	.83	.49	.57
	50	19	.94	.50	.58
360°	30	16	1.35	.51	.59
	40	18	1.70	.51	.58
	50	19	1.90	.51	.58

Performance Data, Metric

RN200-ADJ (blue)

ARC DEGREE	PRESSURE Bar	RADIUS Meters	FLOW L/M	PRECIP mm/hr	
				■	▲
90°	2,1	4,88	1,29	13	15
	2,8	5,49	1,55	12	14
	3,5	5,79	1,78	13	15
180°	2,1	4,88	2,54	13	15
	2,8	5,49	3,14	12	14
	3,5	5,79	3,56	13	15
360°	2,1	4,88	5,11	13	15
	2,8	5,49	6,44	13	15
	3,5	5,79	7,19	13	15

Performance Data

RN300-ADJ (red)

ARC DEGREE	PRESSURE PSI	RADIUS Feet	FLOW GPM	PRECIP in/hr	
				■	▲
90°	30	26	.80	.46	.53
	40	27	.90	.48	.55
	50	29	1.00	.46	.53
180°	30	26	1.50	.43	.49
	40	27	1.60	.42	.49
	50	29	1.80	.41	.48
360°	30	26	3.00	.43	.49
	40	27	3.20	.42	.49
	50	28	3.80	.47	.54

Performance Data, Metric

RN300-ADJ (red)

ARC DEGREE	PRESSURE Bar	RADIUS Meters	FLOW L/M	PRECIP mm/hr	
				■	▲
90°	2,1	7,92	3,03	12	13
	2,8	8,23	3,41	12	14
	3,5	8,84	3,79	12	13
180°	2,1	7,92	5,68	11	12
	2,8	8,23	6,06	11	12
	3,5	8,84	6,81	10	12
360°	2,1	7,92	11,36	11	12
	2,8	8,23	12,11	11	12
	3,5	8,83	14,38	12	14

*Data represents test results in zero wind. Adjust for local conditions.



High Efficiency KVF Nozzles

Complete flexibility for working in a variety of terrains.

Features

- Superior Spray Patterns
- Fits any male-thread spray body
- Color-coded for Easy Identification
- Uniform Water Distribution
- Water Efficient Low Flow Rates
- Extra Long Filters Extend Time Between Cleanings

Models

KVF8
8' (2,4 m) Nozzle,
Green

KVF10
10' (3 m) Nozzle,
Blue

KVF12
12' (3,7 m) Nozzle,
Brown

KVF15
15' (4,6 m) Nozzle,
Black

KVF17
17' (5,2 m) Nozzle,
Grey

Performance Data

KVF-8 8' (2,4 m) Nozzle (green)

ARC DEGREE	PRESSURE PSI	RADIUS Feet	FLOW GPM	PRECIP in/hr	
				■	▲
90°	20	9	.39	1.85	2.14
	25	10	.42	1.62	1.87
	30	10	.50	1.93	2.22
	40	11	.61	1.94	2.24
180°	20	9	.75	1.78	2.06
	25	9	.85	2.02	2.33
	30	10	1.00	1.93	2.22
	40	10	1.16	2.23	2.58
270°	20	9	1.15	1.82	2.10
	25	9	1.25	1.98	2.29
	30	10	1.50	1.93	2.22
	40	10	1.75	2.25	2.59
360°	20	9	1.50	1.78	2.06
	25	9	1.70	2.02	2.33
	30	10	2.00	1.93	2.22
	40	10	2.30	2.21	2.56

Performance Data

KVF-10 10' (3 m) Nozzle (blue)

ARC DEGREE	PRESSURE PSI	RADIUS Feet	FLOW GPM	PRECIP in/hr	
				■	▲
90°	20	10	.45	1.73	2.00
	25	11	.54	1.72	1.98
	30	12	.62	1.66	1.91
	40	12	.70	1.87	2.16
180°	20	10	.90	1.73	2.00
	25	11	1.10	1.75	2.02
	30	12	1.25	1.67	1.93
	40	12	1.40	1.87	2.16
270°	20	10	1.35	1.73	2.00
	25	11	1.65	1.75	2.02
	30	12	1.85	1.65	1.90
	40	12	2.10	1.87	2.16
360°	20	10	1.80	1.73	2.00
	25	11	2.20	1.75	2.02
	30	12	2.50	1.67	1.93
	40	12	2.80	1.87	2.16

Performance Data, Metric

KVF-8 8' (2,4 m) Nozzle (green)

ARC DEGREE	PRESSURE Bar	RADIUS Meters	FLOW L/M	PRECIP mm/hr	
				■	▲
90°	1,38	2,7	1,48	47	54
	1,72	3,1	1,59	41	47
	2,07	3,1	1,89	49	56
	2,76	3,4	2,31	49	57
180°	1,38	2,7	2,84	45	52
	1,72	2,7	3,22	51	59
	2,07	3,1	3,79	49	56
	2,76	3,1	4,39	57	65
270°	1,38	2,7	4,35	46	53
	1,72	2,7	4,73	50	58
	2,07	3,1	5,68	49	56
	2,76	3,1	6,62	57	66
360°	1,38	2,7	5,68	45	52
	1,72	2,7	6,44	51	59
	2,07	3,1	7,57	49	56
	2,76	3,1	8,71	56	65

Performance Data, Metric

KVF-10 10' (3 m) Nozzle (blue)

ARC DEGREE	PRESSURE Bar	RADIUS Meters	FLOW L/M	PRECIP mm/hr	
				■	▲
90°	1,38	3,1	1,70	44	51
	1,72	3,4	2,04	44	50
	2,07	3,7	2,35	42	49
	2,76	3,7	2,65	47	55
180°	1,38	3,1	3,41	44	51
	1,72	3,4	4,16	44	51
	2,07	3,7	4,73	42	49
	2,76	3,7	5,30	47	55
270°	1,38	3,1	5,11	44	51
	1,72	3,4	6,25	44	51
	2,07	3,7	7,00	42	48
	2,76	3,7	7,95	47	55
360°	1,38	3,1	6,81	44	51
	1,72	3,4	8,33	44	51
	2,07	3,7	9,46	42	49
	2,76	3,7	10,60	47	55

*Data represents test results in zero wind. Radius may be reduced with the radius reduction screw. **Bold = recommended pressure of 30 PSI**



Performance Data

KVF-12 12' (3,7 m) Nozzle (brown)

ARC DEGREE	PRESSURE PSI	RADIUS Feet	FLOW GPM	PRECIP in/hr	
				■	▲
90°	20	12	.65	1.74	2.01
	25	13	.70	1.59	1.84
	30	14	.80	1.57	1.81
	40	14	.90	1.77	2.04
180°	20	12	1.30	1.74	2.01
	25	13	1.40	1.59	1.84
	30	14	1.60	1.57	1.81
	40	14	1.80	1.77	2.04
270°	20	12	1.90	1.69	1.96
	25	13	2.10	1.59	1.84
	30	14	2.40	1.57	1.81
	40	14	2.60	1.70	1.97
360°	20	12	2.20	1.47	1.70
	25	13	2.60	1.48	1.71
	30	14	3.10	1.52	1.76
	40	14	3.50	1.72	1.98

Performance Data, Metric

KVF-12 12' (3,7 m) Nozzle (brown)

ARC DEGREE	PRESSURE Bar	RADIUS Meters	FLOW L/M	PRECIP mm/hr	
				■	▲
90°	1,38	3,7	2,46	44	51
	1,72	4,0	2,65	40	47
	2,07	4,3	3,03	40	46
	2,76	4,3	3,41	45	52
180°	1,38	3,7	4,92	44	51
	1,72	4,0	5,30	40	47
	2,07	4,3	6,06	40	46
	2,76	4,3	6,81	45	52
270°	1,38	3,7	7,19	43	50
	1,72	4,0	7,95	40	47
	2,07	4,3	9,08	40	46
	2,76	4,3	9,84	43	50
360°	1,38	3,7	8,33	37	43
	1,72	4,0	9,84	38	43
	2,07	4,3	11,73	39	45
	2,76	4,3	13,25	44	50

Performance Data

KVF-15 15' (4,6 m) Nozzle (black)

ARC DEGREE	PRESSURE PSI	RADIUS Feet	FLOW GPM	PRECIP in/hr	
				■	▲
90°	20	14	.75	1.47	1.70
	25	15	.85	1.45	1.68
	30	15	.95	1.63	1.88
	40	17	1.10	1.47	1.69
180°	20	14	1.40	1.38	1.59
	25	15	1.70	1.45	1.68
	30	15	1.90	1.63	1.88
	40	17	2.30	1.53	1.77
270°	20	14	2.25	1.47	1.70
	25	15	2.55	1.45	1.68
	30	15	2.80	1.60	1.84
	40	17	3.40	1.51	1.74
360°	20	14	3.00	1.47	1.70
	25	15	3.40	1.45	1.68
	30	15	3.80	1.63	1.88
	40	17	4.60	1.53	1.77

Performance Data, Metric

KVF-15 15' (4,6 m) Nozzle (black)

ARC DEGREE	PRESSURE Bar	RADIUS Meters	FLOW L/M	PRECIP mm/hr	
				■	▲
90°	1,38	4,3	2,84	37	43
	1,72	4,6	3,22	37	43
	2,07	4,6	3,60	41	48
	2,76	5,2	4,16	37	43
180°	1,38	4,3	5,30	35	40
	1,72	4,6	6,44	37	43
	2,07	4,6	7,19	41	48
	2,76	5,2	8,71	39	45
270°	1,38	4,3	8,52	37	43
	1,72	4,6	9,65	37	43
	2,07	4,6	10,60	41	47
	2,76	5,2	12,87	38	44
360°	1,38	4,3	11,36	37	43
	1,72	4,6	12,87	37	43
	2,07	4,6	14,38	41	48
	2,76	5,2	17,41	39	45

Performance Data

KVF-17 17' (5,2 m) Nozzle (grey)

ARC DEGREE	PRESSURE PSI	RADIUS Feet	FLOW GPM	PRECIP in/hr	
				■	▲
90°	20	17	.85	1.13	1.31
	25	17	.95	1.27	1.46
	30	18	1.05	1.25	1.44
	40	18	1.20	1.43	1.65
180°	20	16	1.70	1.28	1.48
	25	17	1.90	1.27	1.46
	30	18	2.10	1.25	1.44
	40	18	2.40	1.43	1.65
270°	20	16	2.50	1.25	1.45
	25	17	2.80	1.24	1.44
	30	18	3.15	1.25	1.44
	40	18	3.60	1.43	1.65
360°	20	16	3.40	1.28	1.48
	25	17	3.80	1.27	1.46
	30	18	4.20	1.25	1.44
	40	18	4.80	1.43	1.65

Performance Data, Metric

KVF-17 17' (5,2 m) Nozzle (grey)

ARC DEGREE	PRESSURE Bar	RADIUS Meters	FLOW L/M	PRECIP mm/hr	
				■	▲
90°	1,38	5,2	3,22	29	33
	1,72	5,2	3,60	32	37
	2,07	5,5	3,97	32	37
	2,76	5,5	4,54	36	42
180°	1,38	4,9	6,44	32	37
	1,72	5,2	7,19	32	37
	2,07	5,5	7,95	32	37
	2,76	5,5	9,08	36	42
270°	1,38	4,9	9,46	32	37
	1,72	5,2	10,60	32	36
	2,07	5,5	11,92	32	37
	2,76	5,5	13,63	36	42
360°	1,38	4,9	12,87	32	37
	1,72	5,2	14,38	32	37
	2,07	5,5	15,90	32	37
	2,76	5,5	18,17	36	42

*Data represents test results in zero wind. Radius may be reduced with the nozzle retention screw. **Bold = recommended pressure of 30 PSI.**



nozzles

KV Nozzles

Adjustable pattern, male-threaded nozzles.

Features

- Superior Spray Patterns
- Fits K-Rain® K-Spray™ bodies
- Color-coded for Easy Identification
- Extra Long Filters Extend Time Between Cleanings

Models

KV8

8' (2,4 m) Nozzle,
■ Green

KV10

10' (3 m) Nozzle,
■ Blue

KV12

12' (3,7 m) Nozzle,
■ Brown

KV15

15' (4,6 m) Nozzle,
■ Black

KV17

17' (5,2 m) Nozzle,
■ Grey

Performance Data

KV-8 8' (2,4 m) Nozzle (Green)

ARC DEGREE	PRESSURE PSI	RADIUS Feet	FLOW GPM	PRECIP in/hr	
				■	▲
90°	20	7	.30	2.36	2.72
	30	8	.40	2.41	2.78
	40	8	.40	2.41	2.78
	50	9	.40	1.90	2.20
180°	20	7	.80	3.14	3.63
	30	8	.90	2.71	3.13
	40	8	1.00	3.01	3.47
	50	9	1.10	2.61	3.02
270°	20	7	1.20	3.14	3.63
	30	8	1.20	2.41	2.78
	40	8	1.30	2.61	3.01
	50	9	1.50	2.38	2.74
360°	20	7	1.90	3.73	4.31
	30	8	2.00	3.01	3.47
	40	8	2.20	3.31	3.82
	50	9	2.30	2.73	3.16

Performance Data, Metric

KV-8 8' (2,4 m) Nozzle (Green)

ARC DEGREE	PRESSURE Bar	RADIUS Meters	FLOW L/M	PRECIP mm/hr	
				■	▲
90°	1,38	2,1	1,14	60	69
	2,07	2,4	1,51	61	70
	2,76	2,4	1,51	61	70
	3,45	2,7	1,51	48	56
180°	1,38	2,1	3,03	80	92
	2,07	2,4	3,41	69	79
	2,76	2,4	3,79	76	88
	3,45	2,7	4,16	66	77
270°	1,38	2,1	4,54	80	92
	2,07	2,4	4,54	61	70
	2,76	2,4	4,92	66	76
	3,45	2,7	5,68	60	70
360°	1,38	2,1	7,19	95	109
	2,07	2,4	7,57	76	88
	2,76	2,4	8,33	84	97
	3,45	2,7	8,71	69	80

Performance Data

KV-10 10' (3 m) Nozzle (Blue)

ARC DEGREE	PRESSURE PSI	RADIUS Feet	FLOW GPM	PRECIP in/hr	
				■	▲
90°	20	12	.70	1.87	2.16
	30	12	1.10	2.94	3.40
	40	13	1.40	3.19	3.68
	50	14	1.50	2.95	3.40
180°	20	11	1.40	2.23	2.57
	30	11	1.60	2.55	2.94
	40	12	1.80	2.41	2.78
	50	13	2.00	2.28	2.63
270°	20	10	1.70	2.18	2.52
	30	10	2.00	2.57	2.96
	40	11	2.30	2.44	2.82
	50	12	2.60	2.32	2.68
360°	20	10	2.20	2.12	2.45
	30	10	2.70	2.60	3.00
	40	11	3.00	2.39	2.76
	50	12	3.50	2.34	2.70

Performance Data, Metric

KV-10 10' (3 m) Nozzle (Blue)

ARC DEGREE	PRESSURE Bar	RADIUS Meters	FLOW L/M	PRECIP mm/hr	
				■	▲
90°	1,38	3,7	2,65	47	55
	2,07	3,7	4,16	75	86
	2,76	4,0	5,30	81	93
	3,45	4,3	5,68	75	86
180°	1,38	3,4	5,30	56	65
	2,07	3,4	6,06	65	75
	2,76	3,7	6,81	61	70
	3,45	4,0	7,57	58	67
270°	1,38	3,1	6,44	55	64
	2,07	3,1	7,57	65	75
	2,76	3,4	8,71	62	71
	3,45	3,7	9,84	59	68
360°	1,38	3,1	8,33	54	62
	2,07	3,1	10,22	66	76
	2,76	3,4	11,36	61	70
	3,45	3,7	13,25	59	69

Performance Data

KV-12 12' (3,7 m) Nozzle (Brown)

ARC DEGREE	PRESSURE PSI	RADIUS Feet	FLOW GPM	PRECIP in/hr	
				■	▲
90°	20	12	1.10	2.94	3.40
	30	13	1.30	2.96	3.42
	40	14	1.50	2.95	3.40
	50	15	1.70	2.91	3.36
180°	20	11	1.60	2.55	2.94
	30	12	1.80	2.41	2.78
	40	13	2.20	2.51	2.89
	50	14	2.40	2.36	2.72
270°	20	11	1.90	2.02	2.33
	30	12	2.40	2.14	2.47
	40	12	2.60	2.32	2.68
	50	13	3.20	2.43	2.81
360°	20	11	2.80	2.23	2.57
	30	12	3.10	2.07	2.39
	40	12	3.50	2.34	2.70
	50	13	3.90	2.22	2.56

Performance Data, Metric

KV-12 12' (3,7 m) Nozzle (Brown)

ARC DEGREE	PRESSURE Bar	RADIUS Meters	FLOW L/M	PRECIP mm/hr	
				■	▲
90°	1,38	3,7	4,16	75	86
	2,07	4,0	4,92	75	87
	2,76	4,3	5,68	75	86
	3,45	4,6	6,44	74	85
180°	1,38	3,4	6,06	65	75
	2,07	3,7	6,81	61	70
	2,76	4,0	8,33	64	73
	3,45	4,3	9,08	60	69
270°	1,38	3,4	7,19	51	59
	2,07	3,7	9,08	54	63
	2,76	3,7	9,84	59	68
	3,45	4,0	12,11	62	71
360°	1,38	3,4	10,60	56	65
	2,07	3,7	11,73	53	61
	2,76	3,7	13,25	59	69
	3,45	4,0	14,76	56	65

*Data represents test results in zero wind. Radius may be reduced with the nozzle retention screw. **Bold = recommended pressure of 30 PSI.**

Performance Data

KV-15 15' (4,6 m) Nozzle (Black)

ARC DEGREE	PRESSURE PSI	RADIUS Feet	FLOW GPM	PRECIP in/hr	
				■	▲
90°	20	15	1.30	2.22	2.57
	30	17	1.60	2.13	2.46
	40	18	1.80	2.14	2.47
	50	19	2.00	2.13	2.46
180°	20	14	1.80	1.77	2.04
	30	15	2.30	1.97	2.27
	40	16	2.60	1.96	2.26
	50	18	2.80	1.66	1.92
270°	20	14	2.70	1.77	2.04
	30	15	3.20	1.83	2.11
	40	16	3.60	1.80	2.08
	50	18	4.00	1.58	1.83
360°	20	14	3.40	1.67	1.93
	30	15	4.20	1.80	2.07
	40	16	4.70	1.77	2.04
	50	16	5.30	1.99	2.30

Performance Data, Metric

KV-15 15' (4,6 m) Nozzle (Black)

ARC DEGREE	PRESSURE Bar	RADIUS Meters	FLOW L/M	PRECIP mm/hr	
				■	▲
90°	1,38	4,6	4,92	56	65
	2,07	5,2	6,06	54	62
	2,76	5,5	6,81	54	63
	3,45	5,8	7,57	54	62
180°	1,38	4,3	6,81	45	52
	2,07	4,6	8,71	50	58
	2,76	4,9	9,84	50	57
	3,45	5,5	10,60	42	49
270°	1,38	4,3	10,22	45	52
	2,07	4,6	12,11	46	53
	2,76	4,9	13,63	46	53
	3,45	5,5	15,14	40	46
360°	1,38	4,3	12,87	42	49
	2,07	4,6	15,90	46	53
	2,76	4,9	17,79	45	52
	3,45	4,9	20,06	51	58

nozzles

Performance Data

KV-17 17' (5,2 m) Nozzle (Grey)

ARC DEGREE	PRESSURE PSI	RADIUS Feet	FLOW GPM	PRECIP in/hr	
				■	▲
90°	20	18	1.70	2.02	2.33
	30	18	1.80	2.14	2.47
	40	19	2.00	2.13	2.46
	50	20	2.20	2.12	2.45
180°	20	17	1.90	1.27	1.46
	30	18	2.40	1.43	1.65
	40	19	2.60	1.39	1.60
	50	19	2.90	1.55	1.79
270°	20	16	2.90	1.45	1.68
	30	17	3.40	1.51	1.74
	40	18	4.00	1.58	1.83
	50	18	4.50	1.78	2.06
360°	20	15	3.50	1.50	1.73
	30	17	4.40	1.47	1.69
	40	17	4.90	1.63	1.88
	50	18	5.40	1.60	1.85

Performance Data, Metric

KV-17 17' (5,2 m) Nozzle (Grey)

ARC DEGREE	PRESSURE Bar	RADIUS Meters	FLOW L/M	PRECIP mm/hr	
				■	▲
90°	1,38	5,5	6,44	51	59
	2,07	5,5	6,81	54	63
	2,76	5,8	7,57	54	62
	3,45	6,1	8,33	54	62
180°	1,38	5,2	7,19	32	37
	2,07	5,5	9,08	36	42
	2,76	5,8	9,84	35	41
	3,45	5,8	10,98	39	45
270°	1,38	4,9	10,98	37	43
	2,07	5,2	12,87	38	44
	2,76	5,5	15,14	40	46
	3,45	5,5	17,03	45	52
360°	1,38	4,6	13,25	38	44
	2,07	5,2	16,66	37	43
	2,76	5,2	18,55	41	48
	3,45	5,5	20,44	41	47

*Data represents test results in zero wind. Radius may be reduced with the nozzle retention screw. **Bold = recommended pressure of 30 PSI.**



Fixed Pattern Nozzles

Male-threaded, female-threaded and special patterns for system flexibility.

Features

- Four distances plus eight fixed patterns provide an array of system configurations
- Color-coded for easy identification

Models

FN8

8' (2,4 m) Female Nozzle, Green

FN10

10' (3,0 m) Female Nozzle, Blue

FN12

12' (3,7 m) Female Nozzle, Brown

FN15

15' (4,6 m) Female Nozzle, Black

P12

12' (3,7 M) Male Nozzle, Brown

P15

15' (4,6 m) Male Nozzle, Black

15CS

Center Strip, Male

15ES

End Strip, Male

15SS

Side Strip, Male

15HL

High Low, Male

FN15CS

Center Strip, Female

FN15ES

End Strip, Female

FN15SS





Side Strip, Female

FN15HL

High Low, Female





Performance Data

FN-8 8' (2,4 m) Nozzle, Female (green)

NOZZLE/ PATTERN	PRESSURE PSI	RADIUS Feet	FLOW GPM	PRECIP in/hr	
				■	▲
90° FN8Q 	20	6	.21	2.25	2.59
	25	7	.24	1.89	2.18
	30	8	.26	1.56	1.81
180° FN8H 	20	6	.42	2.25	2.59
	25	7	.47	1.85	2.13
	30	8	.52	1.56	1.81
270° FN8TQ 	20	6	.63	2.25	2.59
	25	7	.71	1.86	2.15
	30	8	.78	1.56	1.81
360° FN8F 	20	6	.86	2.30	2.66
	25	7	.96	1.89	2.18
	30	8	1.05	1.58	1.82





Performance Data

FN-10 10' (3 m) Nozzle, Female (blue)

NOZZLE/ PATTERN	PRESSURE PSI	RADIUS Feet	FLOW GPM	PRECIP in/hr	
				■	▲
90° FN10Q 	20	8	.33	1.99	2.29
	25	9	.36	1.71	1.98
	30	10	.39	1.50	1.73
180° FN10H 	20	8	.65	1.96	2.26
	25	9	.72	1.71	1.98
	30	10	.79	1.52	1.76
270° FN10TQ 	20	8	.98	1.97	2.27
	25	9	1.08	1.71	1.98
	30	10	1.18	1.51	1.75
360° FN10F 	20	8	1.03	1.55	1.79
	25	9	1.44	1.71	1.98
	30	10	1.58	1.52	1.76





Performance Data

FN-12 12' (3,7 m) Nozzle, Female (brown)

NOZZLE/ PATTERN	PRESSURE PSI	RADIUS Feet	FLOW GPM	PRECIP in/hr	
				■	▲
90° FN12Q 	20	10	.53	2.04	2.36
	25	11	.60	1.91	2.20
	30	12	.65	1.74	2.01
180° FN12H 	20	10	1.05	2.02	2.33
	25	11	1.20	1.91	2.20
	30	12	1.30	1.74	2.01
270° FN12TQ 	20	10	1.58	2.03	2.34
	25	11	1.80	1.91	2.20
	30	12	1.95	1.74	2.01
360° FN12F 	20	10	2.10	2.02	2.33
	25	12	2.40	1.91	2.20
	30	12	2.60	1.74	2.01





Performance Data

FN-15 15' (4,6 m) Nozzle, Female (black)

NOZZLE/ PATTERN	PRESSURE PSI	RADIUS Feet	FLOW GPM	PRECIP in/hr	
				■	▲
90° FN15Q 	20	12	.75	2.01	2.32
	25	14	.82	1.61	1.86
	30	15	.92	1.57	1.82
180° FN15H 	20	12	1.50	2.01	2.32
	25	14	1.65	1.62	1.87
	30	15	1.85	1.58	1.83
270° FN15TQ 	20	12	2.25	2.01	2.32
	25	14	2.48	1.62	1.88
	30	15	2.78	1.59	1.83
360° FN15F 	20	12	3.00	2.01	2.32
	25	14	3.30	1.62	1.87
	30	15	3.70	1.58	1.83





Performance Data, Metric

FN-8 8' (2,4 m) Nozzle, Female (green)

NOZZLE/ PATTERN	PRESSURE Bar	RADIUS Meters	FLOW L/M	PRECIP mm/hr	
				■	▲
90° FN8Q 	1,4	1,8	0,80	57	66
	1,7	2,1	0,90	48	55
	2,1	2,4	1,00	40	46
180° FN8H 	1,4	1,8	1,60	57	66
	1,7	2,1	1,80	47	54
	2,1	2,4	2,00	40	46
270° FN8TQ 	1,4	1,8	2,40	57	66
	1,7	2,1	2,70	47	54
	2,1	2,4	3,00	40	46
360° FN8F 	1,4	1,8	3,30	58	67
	1,7	2,1	3,60	48	55
	2,1	2,4	4,00	40	46





Performance Data, Metric

FN-10 10' (3 m) Nozzle, Female (blue)

NOZZLE/ PATTERN	PRESSURE Bar	RADIUS Meters	FLOW L/M	PRECIP mm/hr	
				■	▲
90° FN10Q 	1,4	2,4	1,20	50	58
	1,7	2,7	1,40	43	50
	2,1	3,1	1,50	38	44
180° FN10H 	1,4	2,4	2,50	50	57
	1,7	2,7	2,70	43	50
	2,1	3,1	3,00	39	45
270° FN10TQ 	1,4	2,4	3,70	50	58
	1,7	2,7	4,10	43	50
	2,1	3,1	4,50	38	44
360° FN10F 	1,4	2,4	3,90	39	45
	1,7	2,7	5,50	43	50
	2,1	3,1	6,00	39	45





Performance Data, Metric

FN-12 12' (3,7 m) Nozzle, Female (brown)

NOZZLE/ PATTERN	PRESSURE Bar	RADIUS Meters	FLOW L/M	PRECIP mm/hr	
				■	▲
90° FN12Q 	1,4	3,1	1,51	52	60
	1,7	3,4	1,70	48	56
	2,1	3,7	2,27	44	51
180° FN12H 	1,4	3,1	2,27	51	59
	1,7	3,4	3,03	48	56
	2,1	3,7	3,79	44	51
270° FN12TQ 	1,4	3,1	3,60	51	59
	1,7	3,4	3,79	48	56
	2,1	3,7	4,92	44	51
360° FN12F 	1,4	3,1	6,06	51	59
	1,7	3,4	6,81	48	56
	2,1	3,7	7,95	44	51

Performance Data, Metric

FN-15 15' (4,6 m) Nozzle, Female (black)

NOZZLE/ PATTERN	PRESSURE Bar	RADIUS Meters	FLOW L/M	PRECIP mm/hr	
				■	▲
90° FN15Q 	1,4	3,7	2,80	51	59
	1,7	4,3	3,10	41	47
	2,1	4,6	3,50	40	46
180° FN15H 	1,4	3,7	5,70	51	59
	1,7	4,3	6,20	41	47
	2,1	4,6	7,00	40	46
270° FN15TQ 	1,4	3,7	8,50	51	59
	1,7	4,3	9,40	41	48
	2,1	4,6	10,5	40	46
360° FN15F 	1,4	3,7	11,4	51	59
	1,7	4,3	12,5	41	47
	2,1	4,6	14,0	40	46

*Data represents test results in zero wind. Radius may be reduced with the nozzle retention screw. **Bold = recommended pressure of 30 PSI.**

Performance Data

P-12 12' (3,7 m) Nozzle, Male (brown)

NOZZLE/ PATTERN	PRESSURE PSI	RADIUS Feet	FLOW GPM	PRECIP in/hr	
				■	▲
90° P12Q 	20	11	.40	1.27	1.47
	25	12	.45	1.20	1.39
	30	13	.50	1.13	1.36
	40	14	.60	1.18	1.38
180° P12H 	20	11	.60	.95	1.10
	25	12	.80	1.07	1.23
	30	13	.80	.91	1.13
	40	14	.10	.98	1.19
270° P12TQ 	20	11	.95	1.01	1.16
	25	12	1.00	.89	1.03
	30	13	1.10	.84	.98
	40	14	1.30	.85	.95
360° P12F 	20	11	1.60	1.27	1.47
	25	12	1.80	1.20	1.39
	30	13	1.90	1.08	1.36
	40	14	2.10	1.18	1.38

Performance Data, Metric

P-12 12' (3,7 m) Nozzle, Male (brown)

NOZZLE/ PATTERN	PRESSURE Bar	RADIUS Meters	FLOW L/M	PRECIP mm/hr	
				■	▲
90° P12Q 	1,4	3,4	1,51	32	37
	1,7	3,7	1,70	30	35
	2,8	4,3	2,27	30	35
	3,4	4,6	2,65	30	35
180° P12H 	1,4	3,4	2,27	24	28
	1,7	3,7	3,03	27	31
	2,8	4,3	3,79	25	29
	3,4	4,6	4,54	26	30
270° P12TQ 	1,4	3,4	3,60	26	29
	1,7	3,7	3,79	23	26
	2,8	4,3	4,92	22	25
	3,4	4,6	5,49	21	24
360° P12F 	1,4	3,4	6,06	32	37
	1,7	3,7	6,81	30	35
	2,8	4,3	7,95	30	35
	3,4	4,6	10,6	30	35

Performance Data

P-15 15' (4,6 m) Nozzle, Male (black)

NOZZLE/ PATTERN	PRESSURE PSI	RADIUS Feet	FLOW GPM	PRECIP in/hr	
				■	▲
90° P15Q 	20	13	.60	1.37	1.58
	25	14	.75	1.47	1.70
	30	16	.90	1.35	1.56
	40	17	1.10	1.47	1.69
180° P15H 	20	13	1.20	1.37	1.58
	25	14	1.35	1.33	1.53
	30	16	1.60	1.20	1.39
	40	17	1.90	1.27	1.46
270° P15TQ 	20	13	1.85	1.40	1.62
	25	14	2.10	1.37	1.59
	30	16	2.70	1.35	1.56
	40	17	3.10	1.38	1.59
360° P15F 	20	13	2.80	1.56	1.84
	25	14	3.20	1.57	1.81
	30	16	4.20	1.58	1.82
	40	17	4.60	1.30	1.77

Performance Data, Metric

P-15 15' (4,6 m) Nozzle, Male (black)

NOZZLE/ PATTERN	PRESSURE Bar	RADIUS Meters	FLOW L/M	PRECIP mm/hr	
				■	▲
90° P15Q 	1,4	4,0	2,27	35	40
	1,7	4,3	2,84	37	43
	2,8	4,9	3,41	34	40
	3,4	5,2	4,16	37	43
180° P15H 	1,4	4,0	4,54	35	40
	1,7	4,3	5,11	34	39
	2,8	4,9	6,06	30	35
	3,4	5,2	7,19	32	37
270° P15TQ 	1,4	3,4	7,00	36	41
	1,7	4,3	7,95	35	40
	2,8	4,9	10,22	34	40
	3,4	5,2	11,73	35	40
360° P15F 	1,4	3,4	10,60	40	47
	1,7	4,3	12,11	40	46
	2,8	4,9	15,90	40	46
	3,4	5,2	17,41	33	45

Performance Data

Special Patterns

NOZZLE/ PATTERN	NOZZLE		PRESSURE PSI	W X L Feet	FLOW GPM
	Male#	Female#			
Center Strip 	P15CS	FN15CS	20	4 x 24	0.8
		30	4 x 30	1.0	
End Strip 	P15ES	FN15ES	20	4 x 12	0.4
		30	4 x 15	0.5	
Side Strip 	P15SS	FN15SS	20	4 x 28	1.1
		30	5 x 32	1.3	
High Low 	P15HL	FN15HL	20	High: 14 x 28	2.5
			30	Low: 4 x 28	2.5
			30	High: 15 x 32	3.0
			30	Low: 5 x 32	3.0

Performance Data, Metric

Special Patterns

NOZZLE/ PATTERN	NOZZLE		PRESSURE Bar	W X L Meters	FLOW L/M
	Male#	Female#			
Center Strip 	P15CS	FN15CS	1,5	1,2 x 7,3	3,0
			2,0	1,2 x 9,1	3,8
End Strip 	P15ES	FN15ES	1,5	1,2 x 3,7	1,5
			2,0	1,2 x 4,6	1,9
Side Strip 	P15SS	FN15SS	1,5	1,2 x 8,5	4,2
			2,0	1,5 x 9,8	4,9
High Low 	P15HL	FN15HL	1,5	High: 4,3 x 8,5	9,5
			2,0	Low: 1,2 x 8,5	9,5
			2,0	High: 4,6 x 9,8	11,4
			2,0	Low: 1,5 x 9,8	11,4

*Data represents test results in zero wind. Radius may be reduced with the nozzle retention screw. **Bold = recommended pressure of 30 PSI.**



Drip Irrigation

Efficient and trouble-free operation for non-turf areas.

Features

- Install Above or Below Grade

Dripline:

- Pressure-compensating Emitters – Ensure uniform output across the entire length of run
- In-line Emitter Check Valves – Prevents drainage from the dripline when water pressure drops below 2.5 PSI, protecting against the siphoning of small sediment and soil particles into the drip emitter – ideal for sub-surface installation
- Available in Two Flow Rates and 2 spacing sizes – Provides maximum design flexibility in a variety of applications
- Drip Control Zone Kit – Pre-assembled for quick installation, heavy duty, corrosion resistant, 150 mesh stainless steel filter

Specifications

- Flow rates: .58 GPH (2,3 L/H) color code - orange, 1 GPH (3,8 L/H) color code - gray
- Operating pressure: 12 – 50 PSI (0,8 – 3,5 bar)
- Check valve sealing pressure: 2.5 PSI (0,17 bar)
- Check valve opening pressure: 4.3 PSI (0,3 bar)
- Dripline color: brown
- Size: 1/2" (.570" ID x .670" OD) (14,5 mm ID x 17 mm OD)
- Spacing: 12" or 18" (30,5 cm or 45,7 cm)
- Minimum bending radius: 1' (0,3 m)
- Filter requirement: minimum of 150 mesh

DRIP CONTROL ZONE KIT

- Pressure regulation 30 or 40 PSI (2,1 or 2,8 bar)
- Flow: 1 – 35 GPM (1,9 – 94,6 LPM)
- Operating pressure: 10 – 120 PSI (0,7 – 8,3 bar)
- Solenoid: 24V AC
- Inlet: 1" (2,5 cm) female thread NPT
- Outlet: 1" (2,5 cm) female thread NPT
- Dimensions: Height: 6 1/2" (16,5 cm), Width: 3" (7,6 cm), Length: 14 1/2" (36,8 cm)

Models

KA1-118P -CV	.67" (17 mm) 1 GPH (3,8 LPH), 100' (30,5 m) CV drip line coil w/18" (0,45 m) spacing, .57" ID x .67" OD (14,5 mm ID x 17 mm OD), brown
KA1-218P -CV	.67" (17 mm) 1 GPH (3,8 LPH), 250' (76,2 m) CV drip line coil w/18" (0,45 m) spacing, .57" ID x .67" OD (14,5 mm ID x 17 mm OD), brown
KA5-112P -CV	.67" (17 mm) .58 GPH (2,2 LPH), 100' (30,5 m) CV drip line coil w/12" (0,45 m) spacing, .57" ID x .67" OD (14,5 mm ID x 17 mm OD), brown
KA5-212P -CV	.67" (17 mm) .58 GPH (2,2 LPH), 250' (76,2 m) CV drip line coil w/12" (0,45 m) spacing, .57" ID x .67" OD (14,5 mm ID x 17 mm OD), brown
KA5-512P -CV	.67" (17 mm) .58 GPH (2,2 LPH), 500' (152,4 m) CV drip line coil w/12" (0,45 m) spacing, .57" ID x .67" OD (14,5 mm ID x 17 mm OD), brown
K15-040	.67" (17 mm) barb coupling
K15-041	.67" (17 mm) tee
K15-042	.67" (17 mm) elbow
K15-043	.67" (17 mm) barb x 1/2" (1,27 cm) NPT Tee
K15-046	.67" (17 mm) barb x 1/2" (1,27 cm) NPT Adapter
K18-028	1/2" (1,27 cm) Air/Vacuum Relief Valve
KP11-155	3/4" (1,9 cm) plastic filter with 150 mesh stainless steel screen & flush cap
KP11-374	1" (2,5 cm) plastic LP 1 Y-filter stainless steel screen 150 mesh
KP7001-FPR30-KIT	Drip control zone kit with 30 PSI pressure regulator and filter
KP7001-FPR40-KIT	Drip control zone kit with 40 PSI pressure regulator and filter
KPR8030	1" (2,5 cm) pressure regulator, 30 PSI
KPR8040	1" (2,5 cm) pressure regulator, 40 PSI



Bubblers

Pressure compensating bubblers are ideal for non-turf areas.

www.krain.com

Features

- Pressure compensation ensures consistent flow rates over lower pressure ranges.
- Pressure compensating bubblers are ideal for tree and large shrub watering.

Specifications

- Operating Pressure: 20 – 50 PSI (1,4 – 3,5 bar)
- Spacing: 1' – 3' (0,3 m – 0,9 m)
- Umbrella Pattern

Fast Facts

All	Inlet: 1/2" (1,3 cm) female thread NPT
TB-025	Flow Rate: 0.25 GPM (0,06 M ³ /H; 0,95 L/M)
TB-05	Flow Rate: 0.5 GPM (0,114 M ³ /H; 1,9 L/M)
TB-10	Flow Rate: 1.0 GPM (0,227 M ³ /H; 3,8 L/M)
TB-20	Flow Rate: 2.0 GPM (0,454 M ³ /H; 7,6 L/M)
TB-ADJ	Flow Rate: 0.1 – 4.5 GPM (0,31 – 1,34 M ³ /H; 5 – 22 L/M)

Models

- TB-025** 0.25 GPM (0,95 LPM) Bubbler
- TB-05** 0.5 GPM (1,9 LPM) Bubbler
- TB-10** 1.0 GPM (3,8 LPM) Bubbler
- TB-20** 2.0 GPM (7,6 LPM) Bubbler
- TB-ADJ** Adjustable Bubbler, Pressure Compensating



dripline,
bubblers

valves



Valve Comparison Chart

Versatile and heavy-duty, ProSeries valves deliver long life and reliable performance. Offering a wide array of features and benefits, the K-Rain line is manufactured with the highest standards and provides exceptional functionality.

Item Number	PRO SERIES 100				PRO SERIES 150			PRO SERIES 200		
	7075	7075	7001	7001	7101	7115	7102	7201	7215	7202
Models	Female thread, SL, BSP	NFC, SL-NFC, BSP-NFC	Female thread, SL, BSP, MXB, MXM, BSP-MXM, BSP	BSP-NFC, MXM-NFC, BSP-MXM -NFC, MXB-NFC	Female thread, SL, BSP, J, J-SL, J-BSP, J-MXB	Female thread, BSP	Female thread, BSP	Female thread	Female thread	Female thread
Specifications										
Size	3/4"	3/4"	1"	1"	1"	1 1/2"	2"	1"	1 1/2"	2"
Flow range (GPM)	1-20	1-20	5-30	5-30	5-30	20-80	20-120	5-30	20-100	20-150
Pressure range (PSI)	20-150	20-150	20-150	20-150	10-150	20-150	20-150	6-200	6-200	6-200
Features										
Flow control	•		•		•	•	•	•	•	•
24VAC solenoid	•	•	•	•	•	•	•	•	•	•
Heavy duty, corrosion resistant	•	•	•	•	•	•	•	glass-filled nylon	glass-filled nylon	glass-filled nylon
Tilt diaphragm/piston assembly	•	•	•	•						
Manual external bleed screw	•	•	•	•	•	•	•			
Manual internal bleed through solenoid	•	•	•	•	•	•	•	•	•	•
Captured plunger	•	•	•	•	•	•	•	•	•	•
Self-cleaning metering screen	•	•	•	•						
Removable metering pin					•	•	•			
Angle/Globe Option						•	•			
Heavy duty Santoprene® diaphragm	•	•	•	•	•	•	•			
Glass-filled nylon construction and reinforced rubber diaphragm								•	•	•
Self-cleaning diaphragm	•	•	•	•	•	•	•	•	•	•
Water flow indicator	•	•	•	•	•	•	•	•	•	•
Electric or manual operation	•	•	•	•	•	•	•	•	•	•
Options										
9VDC solenoid	•	•	•	•	•	•	•			
BSP inlet & outlet	•	•	•	•	•	•	•	•	•	•

electric valves

ProSeries 100 Valves

A straight-through flow pattern reduces the risk of trapped debris.

Features

- Heavy Duty, Corrosion and UV Resistant PVC Construction – Increases the life of the valve
- Tilt Diaphragm/Piston Assembly – Allows for a straight flow path of water, increasing the flow rate while reducing friction loss
- Debris Tolerant Design – Offers flexibility for use in potable or non-potable applications
- Manual External Bleed Screw – Provides for manual operation in system start up and easy valve maintenance
- Manual Internal Bleed Through Solenoid – Permits manual operation without discharging water outside valve
- Flow Control with Removable Handle – Delivers precise flow adjustment to the zone and allows you to remove the handle to prevent tampering (Except NFC)
- Captured Plunger – Remove the solenoid without losing the internal plunger
- Self Cleaning Screen – Screen is in flow path of water for self-cleaning action during operation

Fast Facts

7075 (3/4") Models	Height:	4" (10,2 cm)
	Width:	3" (7,6 cm)
	Length:	4 1/2" (11,4 cm)
7001 (1") Models	Height:	4" (10,2 cm)
	Width:	3" (7,6 cm)
	Length:	5 1/4" (13,3 cm)

Operating Specifications

PROSERIES 100 - 3/4" VALVES					
Flow Rate, GPM	1	5	10	15	20
PSI Loss	4.0	5.0	6.0	11.0	14.0
Pressure Range: 20-150 PSI (1,4 - 10,3 bar)					
Flow Range: 1-20 GPM (3,8 -75,7 LPM)					
PROSERIES 100 - 1" VALVES					
Flow Rate, GPM	5	10	15	20	30
PSI Loss	2.2	3.0	3.5	4.0	5.0
Pressure Range: 20-150 PSI (1,4 - 10,3 bar)					
Flow Range: 5-30 GPM (18,9 - 113,6 LPM)					

Electrical Specifications

- Solenoid: 24V AC 60 Hz
- Inrush Current: .43 Amps
- Holding Current: .25 Amps

Accessories

See page 55



Models

7075	3/4" Female NPT Thread
7075-NFC	3/4" Female NPT Thread, No Flow Control
7075-SL	3/4" Female Slip
7075-SL-NFC	3/4" Female Slip, No Flow Control
7075-BSP	3/4" Female BSP Thread
7075-BSP-NFC	3/4" Female BSP Thread, No Flow Control
7001	1" Female NPT Thread x Female NPT Thread
7001-SL	1" Female Slip
7001-BSP	1" Female BSP Thread
7001-NFC	1" Female NPT Thread No Flow Control
7001-SL-NFC	1" Female Slip, No Flow Control

7001-BSP-NFC	1" Female BSP Thread, No Flow Control
7001-MXB	1" Male NPT Thread x 1" Male Barb
7001-MXM	1" Male NPT Thread x 1" Male Thread
7001-BSP-MXM	1" Male BSP Thread x 1" Male BSP Thread
7001-MXM-NFC	1" Male NPT Thread x 1" Male Thread, No Flow Control
7001-BSP-MXM-NFC	1" Male BSP Thread x 1" Male BSP Thread, No Flow Control
7001-MXB-NFC	1" Male NPT Thread x 1" Male Barb, No Flow Control

All valves equipped with 24VAC solenoids.

How to Specify 9 Volt solenoid

MODEL	OPTION
7001	-9VDC

Example: 7001-SL-9VDC

Flow Through

The unique tilted diaphragm creates a better flow path than traditional globe style electric valves by decreasing friction loss and increasing flow rate.



Manual Flow Control

Precisely adjust flow to the zone. Removable handle prevents tampering.



Self-Cleaning Screen

The straight flow path allows debris to move through and the water path flow cleans the diaphragm filter screen. This provides long life in applications using well or lake water.



Captured Plunger Solenoid

Easy removal when servicing without losing internal parts. Epoxy encapsulated solenoid design ensures longevity unlike the competition's overmolded solenoid.



Versatility

These 1" models can accept 1" PVC inside or 1 1/4" PVC fitting or bell end pipe outside

- 7001
- 7001-BSP
- 7001-NFC
- 7001-SL-NFC
- 7001-BSP-NFC



Watch the video. Scan this code with your smartphone camera.



ProSeries 150 Valves

Heavy Duty, Corrosion and UV Resistant PVC Construction.

Features

- Manual External Bleed Screw – Provides for manual operation in system start up
- Manual Internal Bleed through Solenoid – Provides for manual operation without discharging water outside the valve
- Captured Plunger – Allows for the solenoid to be removed without losing the internal plunger
- Flow Control Option – For precise flow adjustment
- Removable Metering Pin – easily clean metering pin without disassembling

1-1/2" AND 2" MODELS

- Removable Inlet Cap – Allows for easy conversion from globe to angle-style valve
- Heavy Duty Diaphragm – Unique design improves durability of diaphragm

JAR-TOP MODELS

- Threaded Jar-Top – Allows for quick removal of the cap for easy servicing after installation
- Glass-Filled Nylon Screw Cap – Increased durability



Fast Facts

7101 (1") Models	Height: 5 1/4" (13,3 cm) Width: 3 1/8" (7,95 cm) Length: Length: 5" (12,7 cm)
7101 (1") with Flow Control	Height: 5 7/8" (14,9 cm) Width: 3 1/8" (7,95 cm) Length: Length: 5" (12,7 cm)
7101 (1") Jar Top Models	Height: 5 1/4" (13,3 cm) Width: 3" (7,6 cm) Length: Length: 4 3/8" (11,1 cm)
7115 (1.5") Models	Height: 8" (20,3 cm) Width: 4-1/4" (10,8 cm) Length: 5-1/2" (14 cm)
7102 (2") Models	Height: 8-7/8" (22,6 cm) Width: 4-7/8" (12,4 cm) Length: 6-1/3" (16,1 cm)

Models

7101	1" Female NPT Thread
7101-SL	1" Female Slip
7101-BSP	1" Female BSP Thread
7101-BSP-FC	1" Female BSP Thread, with Flow Control
7101-FC	1" Female NPT Thread, with Flow Control
7101-SL-FC	1" Female Slip with Flow Control
7101-J	1" Female NPT Thread Jar-Top
7101-J-SL	1" Female Slip Jar-Top
7101-J-BSP	1" Female BSP Thread Jar-Top
7101-J-MXB	1" Male NPT Thread x 1" Barb Jar-Top
7115	1 1/2" Female NPT Thread
7115-BSP	1 1/2" Female BSP Thread
7102	2" Female NPT Thread
7102-BSP	2" Female BSPT Thread

How to Specify 9 Volt solenoid

MODEL	OPTION
7101	-9VDC

Example: 7101-SL-9VDC

Operating Specifications

7101 PROSERIES 150 1" (2,5 cm) VALVE					
Flow Rate, GPM	5	10	15	20	30
PSI Loss	2.9	2.1	1.8	3.0	5.0
Pressure Range: 10-150 PSI (0,7 – 10,3 bar)					
Flow Range: 5-30 GPM (18,9 – 113,6 LPM)					

7101-FC PROSERIES 150 1" (2,5 cm) VALVE					
Flow Rate, GPM	5	10	15	20	30
PSI Loss	6	4.1	4.1	3.1	6.0
Pressure Range: 10-150 PSI (0,7 – 10,3 bar)					
Flow Range: 5-30 GPM (18,9 – 113,6 LPM)					

7101 PROSERIES 150 1" (2,5 cm) VALVE W/ JAR-TOP					
Flow Rate, GPM	5	10	15	20	30
PSI Loss	3.3	3.9	2.9	3.2	6.1
Pressure Range: 10-150 PSI (0,7 – 10,3 bar)					
Flow Range: 5 – 30 GPM (18,9 – 113,8 LPM)					

7115 PROSERIES 150 1-1/2" (3,8 cm) VALVE						
Flow Rate, GPM	20	30	40	50	60	80
PSI Loss, Globe	3.0	2.6	2.3	2.9	4.1	5.5
PSI Loss, Angle	2.7	2.2	1.9	2.2	3.0	4.4
Pressure Range: 20-150 PSI (1,4 – 10,3 bar)						
Flow Range: 20 – 80 GPM (75,7 – 302,8 LPM)						

7102 PROSERIES 150 2" (5 cm) VALVE								
Flow Rate, GPM	20	30	40	50	60	80	100	120
PSI Loss, Globe	2.2	1.9	1.7	1.5	1.6	2.9	4.8	6.2
PSI Loss, Angle	1.9	1.9	1.7	1.5	1.5	2.1	3.2	4.6
Pressure Range: 20-150 PSI (1,4 – 10,3 bar)								
Flow Range: 20 – 120 GPM (75,7 – 454, 2 LPM)								

Electrical Specifications

- Standard Solenoid: 24V AC 60 Hz
- Inrush Current: .43 Amps
- Holding Current: .25 Amps

Accessories

See page 55

Manual External Bleed Screw

The 1", 1 1/2" and 2" models feature a removable external bleed screw and metering pin to simplify cleaning and maintenance. With the External Bleed Screw, manual operation during start up is easy.

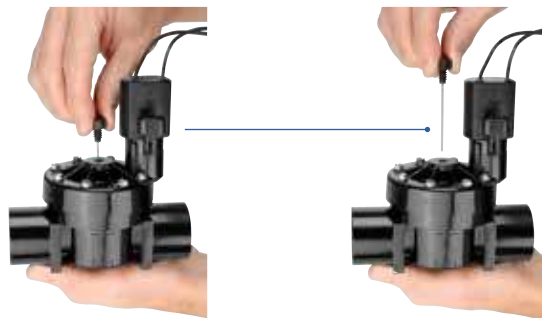

No Tools Required

The K-Rain Jar-Top valve allows for quick and easy servicing after installation.



System Flexibility

Removable inlet cap allows for easy conversion from globe to angle-style valve.



ProSeries 200 Valves

A durable, feature-packed electric valve designed to handle up to 200 PSI.

Features

- Durable Glass-filled Nylon Construction and Reinforced Rubber Diaphragm – Ensures long life and reliable performance
- Flow Control – Adjust water flow as needed
- Large Internal Openings and Self-cleaning Diaphragm During Every Cycle – Reduces maintenance time
- Water Flow Indicator – Ensures proper installation every time
- Electric or Manual Operation

Models

- 7201** 1" Female NPT Thread
7215 1 1/2" Female NPT Thread
7202 2" Female NPT Thread

How to Specify BSP

MODEL	OPTION
7201	-BSP

Example: 7201-BSP

Electrical Specifications

- Standard solenoid: 24V AC 60 Hz
- Inrush current: .43 amp
- Holding current: .25 amp

Fast Facts

7201 (1") Models	Height: 5-1/4" (13,3 cm) Width: 3-1/8" (7,9 cm) Length: 5-1/8" (13,0 cm)
7201 (1") Jar Top Models	Height: 5-3/4" (14,6 cm) Width: 3-1/8" (8 cm) Length: Length: 4-3/4" (12,0 cm)
7215 (1.5") Models	Height: 6-3/4" (17,2 cm) Width: 4-1/4" (10,8 cm) Length: 6-1/4" (15,9 cm)
7202 (2") Models	Height: 7" (17,8 cm) Width: 4-1/4" (10,8 cm) Length: 7-1/4" (18,4 cm)

Operating Specifications

7201 1" (2,5 cm) VALVE							
Flow Rate, GPM	5	10	15	20	25	30	
PSI Loss	.4	1.16	2.45	4.65	7.25	9.70	
Pressure Rating: 6 - 200 PSI (0,41 – 13,79 bar)							
Flow Range: 5 - 30 GPM (18,9 – 113,6 LPM)							

7215 1.5" (3,8 cm) VALVE								
Flow Rate, GPM	20	25	30	40	50	60	80	100
PSI Loss	2.73	3.04	2.90	2.90	3.41	4.24	7.61	12.9
Pressure Rating: 6 - 200 PSI (0,41 – 13,79 bar)								
Flow Range: 20 - 100 GPM (75,7 – 378,5 LPM)								

7202 2" (5 cm) VALVE											
Flow Rate, GPM	20	25	30	40	50	60	80	100	120	150	
PSI Loss	2.9	2.54	2.17	2.17	2.75	3.4	5.5	7.83	11.66	20.0	
Pressure Rating: 6 - 200 PSI (0,41 – 13,79 bar)											
Flow Range: 20 - 150 GPM (75,7 – 567,8 LPM)											

Accessories

See page 55



Models

SOLENOIDS AND ADAPTERS

- P3008113** 24V AC Solenoid
- P3008114** 9V DC Latching Solenoid
- P3004750** Replacement K-Rain® Kit: 24V solenoid with Rain Bird® & Hunter® adapters (1 each)
- P3004758** Replacement K-Rain® Kit: 9V solenoid with Rain Bird® & Hunter® adapters (1 each)
- P3004760** Rain Bird® & Hunter® adapter for K-Rain® 24V or 9V solenoid (1 each)
- P3004770** K-Rain 24V or 9V solenoid adapters for Rain Bird® (5 pack)
- P3004780** K-Rain 24V or 9V solenoid adapters for Hunter® (5 pack)
- P3004810** 24V Solenoid, 1 Signature Adapter
- P3004815** 9V Solenoid, 1 Signature Adapter
- P3004820** 5 pack Signature Adapters



VALVE BOXES

- VB60** K-Rain Round Valve Box 6" (Box Black, Lid Green)
- VB101** K-Rain Round Valve Box 10" (Box Green, Lid Green)
- VB121** K-Rain Valve Box 12"x 17"x 12" (Box Green, Lid Green)
- VB121-X** K-Rain Valve Extension 12"x 17"x 6" (Box Green, Lid Green)
- VB151** K-Rain Valve Box 15"x 21"x 12" (Box Green, Lid Green)
- VB151-X** K-Rain Valve Extension 15"x 21"x 6" (Box Green, Lid Green)



electric valves

controllers



Controller Comparison Chart

K-Rain controllers offer a full range of water management products to meet the needs of any irrigation project. From the simplest timer to WiFi, Bluetooth or the most advanced 2-wire decoder controller, K-Rain controllers are recognized as feature-packed yet easy to program.

	SiteMaster	Pro EX 2.0	Pro-LC WiFi	BLUE	RPS46
Controller Type	2-Wire Decoder	Modular WiFi Ready	Conventional WiFi Ready	Bluetooth Battery	Mini
Specifications					
Stations/zones	1 to 99	Up to 28	4, 8, 12	1, 2, 4	4, 6
Programs	6	3	3	6	4
Start times per program	6	4	4	8	4
Features					
Hand-held remote control compatible		•		smart device	
App controlled		with WiFi option	with WiFi option	•	
WiFi capability		optional	optional		
Full program display	•	•	•	In app	
Backlit display	•	•			
Seasonal adjust	•	•	•	•	•
Buried valve locator		•	•		
Flow sensor ready	•	•			
Rain/freeze sensor ready	•	•	•	•	•
Weather station ready	•	with WiFi option	with WiFi option		
Permanent memory	•	•	•	•	
Max number of stations running simultaneous	12	1	1	1	1
Station delay	•	•	•		
Pump/MV programmable	Up to 5	•	•	2, 4 stations	•
Geo-locate function				•	
Battery Backup	•	•	•	•	•
Battery Backup Time/Date					9VDC

SiteMaster

2-Wire Decoder Controller

Features

- Number of stations: Up to 99
- Weather station capable
- Connect up to 2 hard-wired flow meters and 3 additional meters attached to decoders in the field
- Rain sensor and rain/freeze sensor ready
- 6 independent programs with 6 start times each
- Full on-screen keyboard makes naming and programming easy and intuitive
- Advanced diagnostics include interactive fault log, decoder signal strength/status
- Largest screen in the industry displays run times, watering days, number of start times
- Two fully independent wire paths for easy layout design and trouble shooting
- Special features include seasonal adjust, station/zone grouping, program backup and restore
- Station delay/overlap and pump pressurization allows dual operation and pressurization for each of 5 separate pump start locations
- Vandal-resistant lockable housing

Fast Facts

3400	Height: 11.91" (30,3 cm) Width: 15 1/2" (39,2 cm) Depth: 6 1/2" (16,33 cm)
3420	Height: 16" (41,0 cm) Width: 18 1/2" (47,0 cm) Depth: 9 1/4" (23,5 cm)
3421	Height: 38" (96,5 cm) Width: 16 1/2" (41,9 cm) Depth: 17 1/4" (43,8 cm)



Specifications

OPERATING SPECIFICATIONS

- Station Run Times: 1 second to 9:59:59 Programs A, B, C, D, E, & F
- Start Times: 6 per program
- Watering Schedule: 7 Day Calendar (any day of the week), odd/even days, interval watering up to 31 days
- Operating Temperature: 0°–140° F (18°–60° C)
- Zone Capacity: 99 zone groups limited to 6 zones and 1 MV/PS per primary line. Add up to 12 zones (A and B total).
- Pump Start Requirements: Pump Starts wired directly to the controller require a K-Rain 1520 or 1510 mini coil power relay. Remote pump start relays on the 2-wire path require a K-Rain 3410 Optical Pump Start Relay in conjunction with a K-Rain 1520 or 1510 mini coil power relay.

ELECTRICAL SPECIFICATIONS

- 2-Wire transformer; Input: 120/240 50/60 Hz
Max Output: 27 VAC 100VA 3.7 AMP
- Midbox Transformer; Input: 120/240 50/60 Hz
Max Output: 24 VAC 40VA 1.71 AMP
- Battery: 2032 Coin Cell (included)
9V alkaline battery (optional, not included)

Models

- 3400** 110 VAC 2-wire decoder controller
- 3400-220** 220 VAC 2-wire decoder controller
- 3420** 110 VAC 2-wire decoder controller in stainless steel cabinet
- 3420-220** 220 VAC 2-wire decoder controller in stainless steel cabinet
- 3421** 110 VAC 2-wire decoder controller on stainless steel pedestal
- 3421-220** 220 VAC 2-wire decoder controller on stainless steel pedestal

*Above models include 3403 2-wire module.

Accessories

See page 67



Watch the video. Scan this code with your smartphone camera.

Pro EX 2.0 Modular Irrigation Controllers

Available as a WiFi kit or WiFi enabled units.

Features

- WiFi enabled – Syncs with wifi to allow functionality through a smartphone, tablet or web browser. Weather IQ with adjustable limits. Remote access and alerts.
- Patented Full Program Display – One screen shows watering days, number of start times, number of stations and special programming.
- Flow Sensor Ready – Connects directly. Has high/low flow abort settings and provides flow data capture up to 7 days on device and full history on web browser when configured as a WiFi controller.
- Rain sensor and rain/freeze sensor ready – Allows automated operation to be controlled by sensor.
- RF Module Connector – Allows for optional installation of wireless accessories: Handheld remote, wireless rain sensor and WiFi hub.
- Diagnostic Circuit Breaker – Identifies and isolates stations with valve or wiring problems (shorts, faults, valve location) while remaining program continues.
- Hot-Swappable 4 Station Modules – Simple controller upgrades from 4 to 28 stations - with NEW 14 station module.
- Advanced Diagnostics – Visual and/or audible alerts when programming errors or other conditions have been detected and are preventing operation.
- Station Delay/Overlap Programming – Additional time between stations or dual operation for issues like well recovery, slow closing valves and water hammer.
- Large Backlit LCD Screen – Best in class visualization for all installations.
- AM/PM or 24 Hour Clock Settings – Allows user to choose the time format desired.
- Manual Start – Manual program operation at the push of a button.
- Permanent Memory – Non-volatile memory saves program during power outages.

Fast Facts

- Height: 7 3/4" (19,6 cm)
- Width: 10" (25,4 cm)
- Depth: 5" (12,7 cm)



Optional extended range antenna and remote shown

- Buried Valve Locate Feature – Helps locate buried valves in field
- Sensor Bypass Switch – Global override of active sensor for all stations
- Master Valve/Pump Start Ready – Programming for individual station(s) operation as needed
- Valve Test Terminal (VT) – Quick and easy matching of field wires with station during installation
- Default Programming – Allows program to be saved and recalled without having to reprogram
- Permanent Day Off – Set any day of the week, regardless of programming, as a non-watering day
- Seasonal Adjust – Quick, easy global adjustment of watering times from 10-200% conserves water
- Built-in Level – Makes leveling the unit easy during install

Specifications

OPERATING SPECIFICATIONS

- Station Run Times:
1 second to 6 hours for all stations
- Number of Programs: 3
- Number of Automatic Start Times:
4 per program
- Program Watering Schedules:
Custom (day of the week),
Interval (1-31 days),
Odd (odd calendar days),
Even (even calendar days)

ELECTRICAL SPECIFICATIONS

- Power Input: 110V AC, 50/60Hz,
240V AC, 50/60Hz
- Power Output: 24V AC 1.25Amp
- Power Backup: Lithium coin-cell battery maintains time and date during primary power outages while the 4 AAA batteries allow for remote programming and LCD viewing



WiFi kit shown

PRO EX 2.0 Modular Irrigation Controllers

Available as a WiFi kit or Wifi enabled units.

Models

INDOOR MODELS

3202ID PRO EX 2.0 4 station indoor modular controller, 110V AC plug pack transformer

3202ID-220 PRO EX 2.0 4 station indoor modular controller, 220V AC plug pack transformer

3202ID-WIFI-KIT PRO EX 2.0 WiFi enabled 4 station indoor modular controller, WiFi hub, RF module, short range antenna, 110V AC plug pack transformer. Free iOS/android apps.

3202ID-220-WIFI-KIT PRO EX 2.0 WiFi enabled 4 station indoor modular controller, WiFi hub, RF module, short range antenna, 220V AC plug pack transformer. Free iOS/android apps

OUTDOOR MODELS

3202 PRO EX 2.0 4 station outdoor modular controller, 110 AC internal transformer

3202-P PRO EX 2.0 4 station indoor modular controller, with pigtail, 110V AC internal transformer

3202-220 PRO EX 2.0, 4 station outdoor modular controller, 220 VAC internal transformer

3202-WIFI-KIT PRO EX 2.0 WiFi enabled 4 station outdoor modular controller, WiFi hub, RF module, short range antenna. Free iOS/android apps.

3202-P-WIFI-KIT PRO EX 2.0 WiFi enabled 4 station outdoor modular controller, WiFi hub, RF module, short range antenna, with pigtail. Free iOS/android app.

3202-220-WIFI-KIT PRO EX 2.0 WiFi enabled 4 station outdoor modular controller, WiFi hub, RF module, short range antenna, 220V AC plug pack transformer. Free iOS/android app.



Accessories

See page 67

Feature-packed, user friendly and now a WiFi-Ready controller.

www.krain.com

Features

- Easy to follow programming
- Large LCD display
- Patented full program display feature shows days, start times, number of stations and special programming
- WiFi requires the BRIDGE WiFi Module, sold separately
- Rain sensor and rain/freeze sensor ready
- Seasonal adjust
- Buried valve locator
- Built-in Level – Makes leveling the unit easy.

Specifications

OPERATING SPECIFICATIONS

- Station Run Times: 1 minute to 6 hours
- Number of Programs: 3
- Number of Automatic Start Times: 4 per program
- Program Watering Schedules:
 - Odd (odd calendar days),
 - Even (even calendar days),
 - Custom (day of the week)
 - Interval 1-31 days

ELECTRICAL SPECIFICATIONS

- Power Input:
 - 110V AC, 50/60Hz
 - 240V AC, 50/60Hz
- Power Output: 24V AC 1.0Amp
- Power Backup: Lithium coin-cell battery maintains time and date during primary power outages.

Fast Facts

All	Height: 7" (17,8 cm)
	Width: 7" (17,8 cm)
	Depth: 3 1/2" (8,9 cm)

Models

OUTDOOR MODELS

3104W	4 station, 110V AC internal transformer
3104W-P	4 station, 110V AC internal transformer w/pigtail
3104W-220	4 station, 220V AC internal transformer
3108W	8 station, 110V AC internal transformer
3108W-P	8 station, 110V AC internal transformer w/pigtail
3108W-220	8 station, 220V AC internal transformer
3112W	12 station, 110V AC internal transformer
3112W-P	12 station, 110V AC internal transformer w/pigtail
3112W-220	12 station, 220V AC internal transformer

INDOOR MODELS

3104WID	4 station, 110V AC plug pack transformer
3104WID-220	4 station, 220V AC plug pack transformer
3108WID	8 station, 110V AC plug pack transformer
3108WID-220	8 station, 220V AC plug pack transformer
3112WID	12 station, 110V AC plug pack transformer
3112WID-220	12 station, 220V AC plug pack transformer
3100-BRIDGE	BRIDGE WiFi Module

Accessories

See page 66



Bridge WiFi Module



RPS™ 46

The easiest to use mini irrigation controller.

Features

- 4 & 6 Station Models – Perfect for residential lawn
- 4 Fully Independent Programs – Allowing up to 4 starts per program. Maximum 16 starts per day
- Seasonal Adjustment – Allows for quick adjustment of watering durations in 10% increments from 10% to 200%
- Rain sensor and rain/freeze sensor ready – Allows automated operation to be controlled by sensor
- Flexible Manual Operation – Run a program, run a station or test system
- Battery Back-Up – Saves program during power outages
- Indoor Models with External Transformer & Plug

Specifications

OPERATING SPECIFICATIONS

- Station Run Times: 1 min. to 12 hrs. 59 min.
- Number of Programs: 4
- Number of Automatic Start Times: 4 per program
- Program Watering Schedules: 7 day calendar with individual day selection, or 1 to 15 day interval, or 365 day calendar for ODD/EVEN day watering
- Master Valve/pump start terminal
- Automatic, semi-automatic and single station manual operation

ELECTRICAL SPECIFICATIONS

- Power Input: 110V AC, 50/60Hz, 240V AC, 50/60Hz
- Power Output: 24V AC, 1.0 AMP
- To Solenoid Valve: 24V AC, 0.5 AMPS max
- Overload protection: Standard 20mm 1.0 AMP fuse
- Power Failure: 9 Volt standard alkaline battery maintains clock and program up to 2 week.
- Wiring: The output circuits should be installed and protected in accordance with wiring rules

Fast Facts

All	Height: 5 3/4" (14,5 cm)
	Width: 4 1/2" (11,43 cm)
	Depth: 1 3/4" (4,3 cm)



Models

3504	4 Station, 110V Plug Pack Transformer
3504-220	4 Station, 220V Plug Pack Transformer (International only)
3506	6 Station, 110V Plug Pack Transformer (International only)
3506-220	6 Station, 220V Plug Pack Transformer

Accessories

See page 66, Rain Sensor

Bluetooth battery powered controller.

Features

- Ideal for areas where AC power is unavailable
- Change controller settings via smartphone, tablet or web browser
- Manage hundreds of controllers from one easy app
- Geo-location feature – see every site, every controller, every program
- CrewView™ feature allows program visibility anywhere
- Alerts you when a battery replacement is required
- Rain sensor and rain/freeze sensor ready – Allows automated operation to be controlled by sensor
- IP68 certified fully waterproof enclosure installs right in the valve box
- 1, 2 and 4 station models.
- Molded out of UV resistant, high impact ABS resin
- Ideal for isolated/remote valve boxes where running power is expensive or difficult
- Standalone – works with 9V DC alkaline battery type.
- Full virtual back up – back up program information & preferences to the cloud for easy future restoration
- Seasonal adjust
- Manually start, stop or suspend your controller(s) from up to 35' away
- Add a passcode lock to each controller for added security

Fast Facts

All	Height: 2 1/8" (5,5 cm)
	Width: 5 1/2" (14 cm)
	Depth: 3 1/2" (9 cm)

Specifications

OPERATING SPECIFICATIONS

- 1, 2 and 4 stations
- Master valve connection (Except for BLUE-1 single station)
- 6 programs, 8 start times
- Bluetooth range; 35' (10 m)

ELECTRICAL SPECIFICATIONS

- Works with 9V DC latching solenoids and a master valve equipped with a 9V DC latching solenoid
- Maximum distance between the timer and solenoid is 98' (30 m) with 18 AWG (.05" or 1,55 mm²)

Models

BLUE-1	1 Station
BLUE-2	2 Station
BLUE-4	4 Station

NEW



Rain Sensor

Turn your irrigation controller into an expert water manager.

Features

UNIVERSAL RAIN SENSOR RECEIVER

- Flexibility. Allows a K-Rain Wireless Rain/Freeze Sensor to be paired with any manufacturer's rain sensor terminal equipped controller
- Simplicity. Provides the advantage of extremely quick, easy installation and programming, along with simple pairing with a K-Rain Rain Sensor
- Weather Resistant. Engineered with impact modified, UV resistant polymer for outdoor exposure
- Maintenance Free. No batteries to replace

RAIN/FREEZE SENSORS

- K-Rain Rain Sensor products efficiently suspend watering during rain and/or freeze periods.
- The K-Rain wireless rain-freeze sensor can be paired with multiple K-Rain PRO EX 2.0 Wifi enabled controllers within range, providing an additional value for the end user. The wired rain sensors work with closed circuit timers.
- 2 in 1 Mounting. Provides flexible installation with standard flat & gutter mounting
- Models 3208-WRFS and 3208-HRFS include a freeze sensor that prevents the irrigation system from starting when temperatures drop to 37°F or below

Models

3208-HRS	Hardwired Rain Sensor
3208-HRFS	Hardwired Rain-Freeze Sensor
3208-WRFS	Wireless Rain/Freeze Sensor for PRO EX 2.0 or PRO EX 2.0 WiFi
3208-WRFS-KIT	Wireless Rain/Freeze Sensor and RF Module for PRO EX 2.0
3208-UWRFS	Universal Wireless Rain/Freeze Sensor



Controller Accessories



www.krain.com

		SiteMaster	PRO EX 2.0	PRO-LC	RPS 46	BLUE
Accessories						
3202-WIFI BUNDLE-KIT	WiFi hub, RF module with small antenna, large antenna with coax cable		•			
3202-220-WIFI-BUNDLE-KIT	WiFi hub, RF module with small antenna, large antenna with coax cable		•			
3401	Single Station Decoder	•				
3402	Surge Protector	•				
3403	2-Wire Module	•				
3410	Optional Pump Start Relay	•				
3414	Pro Weather Station	•				
FS735-10	1" Flow Sensor Assembly	•	•			
FS228-15	1.5" Flow Sensor Assembly	•	•			
FS228-20	2" Flow Sensor Assembly	•	•			
FS228-30	3" Flow Sensor Assembly	•	•			
FS228-40	4" Flow Sensor Assembly	•	•			
3100 BRIDGE	Bridge WiFi Module			•		
3203	Handheld Remote with batteries		•			
3203-KIT	Handheld Remote with batteries, RF Module with short distance antenna, long range antenna and coaxial cable		•			
3205	4 Station Expansion Module		•			
3205-14	14 Station Expansion Module		•			
3206	RF module with short distance antenna		•			
3207	Extended range antenna kit		•			
3209	WiFi Hub		•			
3208-HRS	Hardwired Rain Sensor	•	•	•	•	•
3208-HRFS	Hardwired Rain/Freeze Sensor	•	•	•	•	•
3208-WRFS	Wireless Rain/Freeze Sensor and RF Module	•	•			
3208-WRFS KIT	Wireless Rain/Freeze Sensor and RF Module	•	•			
3208-UWRFS	Universal Wireless Rain/Freeze Sensor	•	•	•	•	

3203



3205



3207



3208-UWRFS



irrigation controllers

Pump Start Relays

The rain-tight, secure, rustproof enclosure provides a safe, secure housing built to last.

Features

- The Pump Start Relay enclosure is constructed with a corrosion resistant, UV resistant, shockproof material



pump start relays

Models

- | | |
|---|--|
| <p>1510 Coil Specifications
120V AC, 60 Hz
Inrush: 35 VA
Sealed: 7.0 VA
Resistance ($\pm 10\%$):
250 OHMS
Mini Coil
24V AC, 50/60 Hz
Inrush: 52 mA</p> | <p>Double Pole, Single Throw
Inductive: 20 AMP
Resistive: 30 AMP
Input: 120V AC - up to 2 H.P.
UL Rated</p> <p>Sealed: 1.2 VA
Resistance ($\pm 10\%$): 155 OHMS</p> |
| <p>1520 Coil Specifications
240V AC, 60 Hz
Inrush: 35 VA
Sealed: 7.0 VA
Resistance ($\pm 10\%$):
1000 OHMS
Mini Coil
24V AC, 50/60 Hz
Inrush: 52 mA</p> | <p>Double Pole, Single Throw
Inductive: 20 AMP
Resistive: 30 AMP
Input: 240V AC - up to 3 H.P.
UL Rated</p> <p>Sealed: 1.2 VA
Resistance ($\pm 10\%$): 155 OHMS</p> |
| <p>1521 Coil Specifications
120V AC, 60 Hz
Inrush: 42 VA
Sealed: 8.5 VA, 3.6 Watts
Resistance ($\pm 10\%$):
210 OHMS</p> | <p>Double Pole, Single Throw
Inductive: 20 AMP
Resistive: 30 AMP
Input: 120V AC - up to 3 H.P.
240V AC - up to 3 H.P.</p> |
| <p>1522 Coil Specifications
24V AC, 60 Hz
Inrush: 35 VA
Sealed: 7 VA, 3 Watts
Resistance ($\pm 10\%$):
11 OHMS</p> | <p>Double Pole, Single Throw
Inductive: 20 AMP
Resistive: 30 AMP
Input: 120V AC - up to 3 H.P.
240V AC - up to 3 H.P.</p> |
| <p>1551 Coil Specifications
120V AC, 60 Hz
Inrush: 77 VA
Sealed: 10 VA, 4 Watts
Resistance ($\pm 10\%$):
89.5 OHMS</p> | <p>Double Pole, Single Throw
Inductive: 40 AMP
Resistive: 50 AMP
Input: 120V AC - up to 3 H.P.
240V AC - up to 5 H.P.</p> |
| <p>1552 Coil Specifications
24V AC, 60 Hz
Inrush: 60 VA
Sealed: 7 VA, 2.3 Watts
Resistance ($\pm 10\%$):
5.61 OHMS</p> | <p>Double Pole, Single Throw
Inductive: 40 AMP
Resistive: 50 AMP
Input: 120V AC - up to 3 H.P.
240V AC - up to 5 H.P.</p> |
| <p>1553 Coil Specifications
24V AC, 60 Hz
Inrush: 60 VA
Sealed: 7 VA, 2.7 Watts
Resistance ($\pm 10\%$):
5.61 OHMS</p> | <p>THREE PHASE OPERATION
Triple Pole, Single Throw
Inductive: 40 AMP
Resistive: 50 AMP
Input: 120V AC - up to 3 H.P.
240V AC - up to 10 H.P.</p> |

Single Station Controller

Time-tested reliability and safe, rain-tight enclosures.

www.krain.com

Features

2100 MODELS

- 24 hour programmable time dial
- Multiple start times
- Wide variety of timing periods
- "Skip-A-Day" 14 day program

2200 MODELS

- Perfect for nursery and other mist applications
- 10 minute programmable dial
- Wide variety of timing periods
- Multiple start times

2500 MODELS

- Prewired for easy connection of a rainswitch, allowing for manual override of rainswitch from controller face



Models

2100 SINGLE STATION CONTROLLERS

2110	Voltage Input: 110V AC, 60 Hz Output: 110V AC, 60 Hz	Rating Single Pole, Single Throw Relay Rated for up to 1 H.P.
2112	Voltage Input: 110V AC, 60 Hz Output: 110V AC, 60 Hz	Rating Double Pole, Single Throw Relay Rated for up to 2 H.P.
2114	Voltage Input: 110V AC, 60 Hz Output: 24V AC, 30 VA	Rating Built-In Transformer
2120	Voltage Input: 220V AC, 60 Hz Output: 220V AC, 60 Hz	Rating Double Pole, Single Throw Relay Rated for up to 2 H.P.
2124	Voltage Input: 220V AC, 60 Hz Output: 24V AC, 20 VA	Rating Built-In Transformer

2200 SHORT DURATION SINGLE STATION CONTROLLERS

2210	Voltage Input: 110V AC, 60 Hz Output: 110V AC, 60 Hz	Rating Relay Rated for up to 1 H.P.
2214	Voltage Input: 110V AC, 60 Hz Output: 24V AC, 30 VA	Rating Built-In Transformer

2500 RAINSWITCH-READY CONTROLLERS

2510	Voltage Input: 110V AC, 60 Hz Output: 110V AC, 60 Hz	Rating Double Pole, Single Throw Relay Rated for up to 2 H.P.
2514	Voltage Input: 110V AC, 60 Hz Output: 24V AC, 30 VA	Rating Built-In Transformer
2520	Voltage Input: 220V AC, 60 Hz Output: 220V AC, 60 Hz	Rating Double Pole, Single Throw Relay Rated for up to 2 H.P.

4000 Series Indexing Valve

A reliable, economical way to automate multiple zoned residential and small commercial irrigation systems.

Features

- ABS Polymer Construction – High-strength, non-corrosive body for long product life
- Available in 4 and 6 Outlet Models – Can quickly and easily change from two to six watering zones
- Simplicity of Design – Valves are easily maintained and serviced for long product life
- Operates at a low 10 GPM (38 LPM) flow rate at Pressures of 25-75 PSI (1,7-5,2 bar) – Reliably automates multiple zoned residential and small commercial irrigation or wastewater systems

Models

FOUR OUTLET MODELS

- 4400** No Cam
- 4402** Cammed for 2 Zone Operation
- 4403** Cammed for 3 Zone Operation
- 4404** Cammed for 4 Zone Operation

SIX OUTLET MODELS

- 4600** No Cam
- 4602** Cammed for 2 Zone Operation
- 4603** Cammed for 3 Zone Operation
- 4604** Cammed for 4 Zone Operation
- 4605** Cammed for 5 Zone Operation
- 4606** Cammed for 6 Zone Operation

Other options add to part number:

- RCW** Reclaimed Water Use

*4000 Series Valves are available with 1" inlet and outlet by custom order

Accessories*

- P7005507** Stem/disk Assembly Standard (.029-White) 10 GPM** (38 LPM)
- P7005509** Stem/disk Assembly Light (.025-Blue) 6 GPM (23 LPM)
- P7005511** Stem/disk Assembly Heavy (.032-Red) 15 GPM (57 LPM)

*Color code identified at the bottom of the disk

**Pre-installed

Fast Facts

All	Non-Corrosive ABS Polymer
	Height: 5 3/4" (14,6 cm) Width: 5 3/4" (14,6 cm)
4 Outlet Models	1 1/4" x 1 1/4" (3,2 cm x 3,2 cm)
6 Outlet Models	1 1/4" x 1" (3,2 cm x 2,5 cm)

Operating Specifications

4 OUTLET VALVE				
Flow Rate, GPM	10	20	30	40
PSI Loss	2.0	3.0	4.5	6.4
Pressure Range:	25-75 PSI (0,7-3,4 bar)			
Flow Range:	10-40 GPM (37,9-151,4 LPM)			

6 OUTLET VALVE			
Flow Rate, GPM	10	20	30
PSI Loss	2.5	4.5	7.5
Pressure Range:	25-75 PSI (0,7-3,4 bar)		
Flow Range:	10-30 GPM (37,9-113,6 LPM)		



6000 Series Indexing Valve

The 6000 line of indexing valves offers exceptional reliability and durability even under the dirtiest water conditions.

Features

- Metal Die-Cast Body – Durable, long lasting and capable of high pressure applications
- Available in 4 and 6 Outlet Models – Can quickly and easily change number of watering zones with a cam change
- Simplicity of Design – Valves are easily maintained & serviced for long product life
- Operates at 15 GPM at Pressures of 25–150 PSI – Ideal for pump-fed systems or high-flow city water systems
- Built-in Atmospheric Vacuum Breaker – Releases any vacuum created between the pump and the valve on shut down

Models

FOUR OUTLET MODELS

- 6402** Cammed for 2 Zone Operation
- 6403** Cammed for 3 Zone Operation
- 6404** Cammed for 4 Zone Operation

SIX OUTLET MODELS

- 6605** Cammed for 5 Zone Operation
- 6606** Cammed for 6 Zone Operation

Other options add to part number:

- RCW** Reclaimed Water Use

Accessories*

- P8003050** Stem/disk Assembly Standard Heavy (.032-Red) 15 GPM** (57 LPM)
- P8003051** Stem/disk Assembly Light (.028-White) 10 GPM (38 LPM)
- P8003052** Stem/disk Assembly Extra Light (.025-Blue) 6 GPM (23 LPM)

*Color code identified at the bottom of the disk
 **Pre-installed

Fast Facts

Valve Top/Housing:	Die Cast Metal
Valve Outlets:	High Strength ABS Polymer
Inlet:	Threaded 1 1/2" (3,8 cm) NPT Connection
Outlets:	Slip & Glue Connections to 1 1/2" (3,8 cm) PVC Pipe
Height:	7" (17,8)
Width:	8" (20,3)

Operating Specifications

4 OUTLET VALVE					
Flow Rate, GPM	20	40	60	80	100
PSI Loss	2.5	3.5	5.0	7.5	10.0
Pressure Range: 25 - 150 PSI (1,7 to 10,3 bar)					
Flow Range: 15-150 GPM (57-568 LPM)					

6 OUTLET VALVE					
Flow Rate, GPM	20	40	60	80	100
PSI Loss	3.0	4.0	6.0	9.0	11.0
Pressure Range: 25 - 150 PSI (1,7 to 10,3 bar)					
Flow Range: 15-150 GPM (57-568 LPM)					



Reclaimed Water (RCW) Series

Rotors, Sprays and Indexing Valves for Reclaimed Water

K-Rain® is a leading manufacturer of rotors, sprays and distribution valves for the reclaimed water industry.

The K-Rain® RCW series is designed specifically for use on reclaimed water systems. Flexibility in system design, achieved through a wide selection of nozzles, guarantees matched precipitation.

Features

RCW ROTORS

- Heavy Duty Rubber Cover (purple) – Seals out dirt and increases product durability, positively identifies the use of reclaimed water reducing liability. Not available on Mini-Pro
- Accepts Low Angle Nozzle – Ensures the correct trajectory of reclaimed water - Not available on Mini-Pro

RCW INDEXING VALVES

- Available in 4 and 6 Outlet Models – Watering zones can be changed quickly and easily
- 4000 RCW Indexing Valve – Automates multiple zoned residential and small commercial wastewater systems
- 6000 RCW Indexing Valve – Metal die-cast body is capable of high pressure applications.



MiniPro®

RPS™ 75

RPS™ 75i

RPS™ Select

SuperPro®

ProPlus®

ProSport®

Pro-S™

K-Spray™

Models

Please refer to product pages for individual product model numbers and performance data.

PRODUCT	PAGE
MiniPro®	04
RPS™ 75	08
RPS™ 75i	10
RPS™ Select	14
SuperPro®	16
ProPlus®	20
ProSport®	22
Pro-S™	28
K-Spray™	31
4000 Series Valves	70
6000 Series Valves	71

4000 Series
Indexing Valves



6000 Series
Indexing Valves



Custom Products

Build your brand

Leave a lasting reminder of your company on each job with customized irrigation products. Your logo, phone and/or web address can appear on the products below - FREE - with minimum order requirement AND Premier Contractor membership.



Requirements

Enrollment in the K-Rain Premier Contractor Program is required for first time custom products purchases. Not a member? Visit: premier.krain.com or use your smartphone camera to scan this code on the opposite page and sign up.

ROTORS (RPS 75, RPS 75I AND SUPERPRO)

- Minimum purchase of one unmixed pallet (1,080 rotors) of RPS 75, RPS 75i or SuperPro rotors from your distributor
- Subsequent purchases will require ½ pallets

LASER-PRINTED CONTROLLER DOORS (PRO EX AND PRO-LC)

- Minimum purchase of one case of controllers from your distributor

PRO-S SPRAY NOZZLE GUARD

- Minimum purchase of one pallet of Pro-S Sprays with Nozzle Guard from your distributor

PRO-S SPRAY TWIST CAP

- Minimum purchase of one pallet of Pro-S Sprays from your distributor

How it works

- Submit your company logo, phone number and/or web address to customerservice@krain.com
- K-Rain will provide a proof for your approval before production begins

Premier Contractor Loyalty Program



Earn cash rebates from your very first purchase.

www.krain.com



K-Rain offers the most generous loyalty program in the industry. The Premier Contractor Program is our way of saying thanks for your business. The program is simple and the rewards great.

Rebates can be redeemed for:

- Distributor credit towards your next purchase of K-Rain products
- Debit cards

As a Premier Contractor you will also receive other benefits of membership to help you build your business

- Free product customization (see page 74 for customizable products)
- Homeowner referrals – leads for installations in your area
- Access to complimentary online marketing tools

Enrollment is easy.

Scan this QR code with your smartphone or tablet and be taken to the online signup page. Or visit www.premier.krain.com.



Join today and begin reaping the rewards!

Design Resources

For irrigation Professionals

The K-Rain® website, www.krain.com is a resource for product manuals, videos, FAQs and other valuable information. But it also is an online tool for design and installation of our products. Whether you are a landscape architect, irrigation designer or other irrigation professional, K-Rain® has developed libraries to help you quickly find the information you need. Visit the site for CAD detail drawing and irrigation designs for sports fields and more.

CAD DETAIL DRAWINGS

WWW.KRAIN.COM/CAD-DETAIL-DRAWINGS

Lay out your irrigation design effectively and efficiently. We offer 2 file formats for each part number for your convenience. PDF and CAD, or computer-aided design (CAD) for:

- Irrigation Controllers & Rain Sensor
- Rotors
- Pro-ST™ Sprays
- Pro-ST™ Sprays with Rotary Nozzles
- Valves

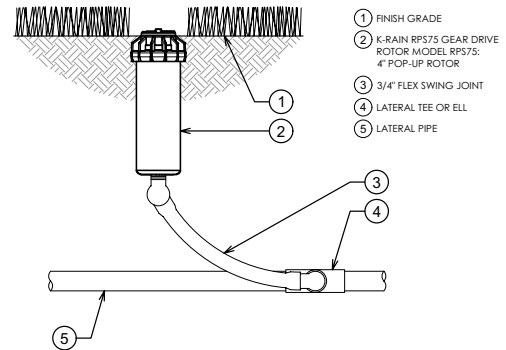

00 K-RAIN RPS75 ROTOR WITH 4\"
3\" = 1\"-0\" www.krain.com

IRRIGATION DESIGNS FOR SPORTS FIELDS

WWW.KRAIN.COM/SPORTS-FIELD-DESIGN

Our Sports Field Irrigation Designs contain Irrigation Design Criteria for water source and head layouts. There you will find pressure and flow water requirements along with general head spacing by field type. A graphic scale is provided on each field type.

- Baseball
 - Baseball Field-5 Row
- Football
 - Football Field-4 Row
 - Football Field-5 Row
- Little League Field
 - Little League Field-3 Row
- Soccer
 - Soccer Field-5 Row
 - Soccer Field-6 Row (ProSport)
 - Soccer Field-6 Row (RPS75i)
- Tennis
 - Double Tennis Court-3 Row

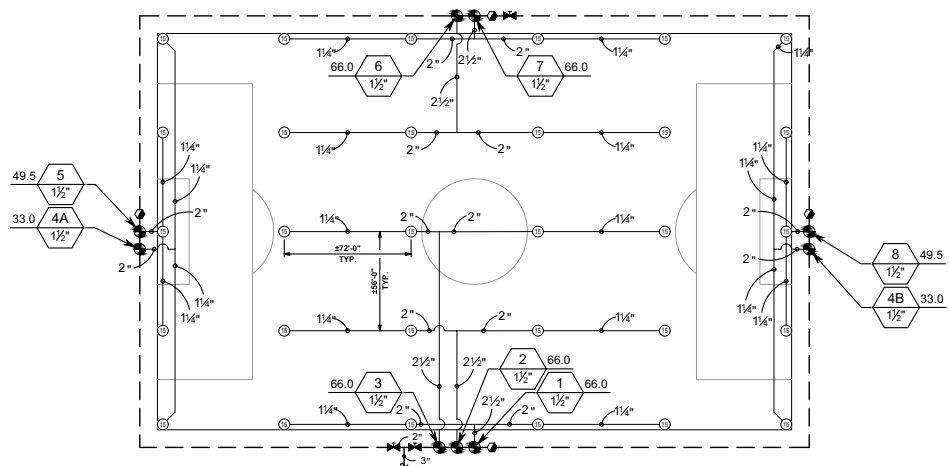

Conversion Table for U.S. and Metric Systems

METRIC TO U.S.				
MULTIPLY		TO OBTAIN		
Millimeters (mm)	x	.03937	=	inches
Centimeters (cm)	x	.3937	=	inches
Meters (m)	x	39.37	=	inches
Meters (m)	x	3.281	=	feet
Meters (m)	x	1.094	=	yards
Kilometers (km)	x	.62137	=	miles
Kilometers (km)	x	1093.62	=	yards
Kilometers (km)	x	3280.87	=	feet
Liters (l)	x	1.0567	=	quarts (liq.)
Liters (l)	x	.2642	=	gallons (U.S.)
Liters (l)	x	.455	=	pounds
Temp. in (C° x 1.80)	+	32°	=	temp. in F°

U.S. TO METRIC				
MULTIPLY		TO OBTAIN		
Inches (in.)	x	25.4	=	millimeters
Inches (in.)	x	2.54	=	centimeters
Inches (in.)	x	.0254	=	meters
Feet (ft.)	x	.3048	=	meters
Yards (yds.)	x	.9144	=	meters
Miles (mi.)	x	1.6093	=	kilometers
Yards (yds.)	x	.0009143	=	kilometers
Feet (ft.)	x	.0003048	=	kilometers
Quarts (qts.)	x	.945	=	liters
Gallons	x	3.78	=	liters
Pounds	x	2.2	=	liters
Temp. in F° - 32°	x	.5666	=	temp. in C°

Kilograms per cubic centimeter (kg/cm²)	x	14.223	=	Pounds per square inch (P.S.I.)
Cubic Foot (cu. ft.) x 28.316			=	Liters (l.)

MISCELLANEOUS CONVERSION FACTORS					
Feet head (ft. hd.) x .433	=	Pounds per square inch (P.S.I.)	Calorie x 3.968	=	British Thermal Unit (B.T.U.)
Pounds per square inch x 2.31	=	Feet head	Foot pounds per second x .7373	=	Watts
Meters x 3.28	=	Feet head	Kilowatts x 1.34	=	Horsepower
Inches of mercury x1.133	=	Feet head	Square foot x 144	=	Square inches
U.S. gallons per minute x .1337	=	Cubic feet per minute	Square yard x 9	=	Square feet
Cubic feet per minute x 7.48	=	U.S. gallons per minute	Acre x 4.840	=	Square yards
British Imperial gallon x 1.201	=	U.S. gallons	Acre x 43,560	=	Square feet
Acre inches per hour x 453	=	G.P.M.	Square mile (section) x 640	=	Acres
Acre foot per day x226	=	G.P.M.	Mile x 5280	=	Feet
1,000,000 gallons per day	=	694 G.P.M.	Cubic yard x 27	=	Cubic Feet
U.S. gallons x .833	=	British Imperial gallon	Circumference of circe x .3183	=	Diameter of circle
U.S. gallon x 8.336	=	Pounds	Diameter of circe x 3.1416	=	Circumference of circle
Acre foot x 325,850	=	U.S. gallons	Diameter of circle squared x .7854	=	Area of circle
Gallons per day x 1,000,000	=	694 gallons per minute	Radius of circle squared x 3.1416	=	Area of circle
U.S. gallons x 231	=	Cubic inches	Cubic Feet per second x 448.8	=	U.S. gallons per minute
Horsepower (H.P.) x 746	=	Watts	Cubic feet per second	=	Gallons per minute - 449
Horsepower x .746	=	Kilowatts	Velocity in feet per second	=	$\frac{.408 \times \text{U.S. g.p.m.}}{\text{Diam. of pipe squared}}$ or $\frac{144Q (\text{flow in G.P.M.})}{A1 (\text{Pipe ID}^2)}$

Charts

Resistance and Valve Wire Sizing

Resistance Method

REQUIRED INFORMATION

- Actual one-way length of wire between the controllers and at the power source of the controllers and valves
- Allowable voltage loss along the wire circuit
- Accumulative current flowing through the wire section being sized in amperes

RESISTANCE IS CALCULATED USING FORMULA:

$$R = \frac{1000 \times AVL}{2L \times I}$$

R = Maximum Allowable Resistance of wire in ohms per 1000 feet

AVL = Allowable voltage loss

L = Wire length (one way)

I = Inrush current

AVL for controller power wire sizing is calculated by subtracting minimum operating voltage required by the controller from minimum available voltage at power source. AVL for valve wire sizing is calculated by subtracting minimum solenoid operating voltage from controller output voltage. This number will vary depending on the manufacturer and in some cases with line pressure.

Valve Wire Sizing Example:

Given: Distance from the controller to the valve is 1800 ft. Controller output is 24V. The valve has a minimum operating voltage of 20V and an inrush current of 370 mA (0.37Amps).

$$R = \frac{1000 \times 4}{2(1800) \times 0.37} \quad R = \frac{4000}{332} \quad R = 3.00 \text{ ohms/} \\ 1000 \text{ feet}$$

Wire resistance can not exceed 3.00 ohms per 1000 feet. Go to table #1 and select the proper wire size. Since 16 gauge wire has more resistance than 3.00 ohms per 1000 feet, choose 14 gauge wire. Table 2 is a quick reference and is set up to provide maximum wire runs given the information at the bottom of the table.

WIRE SIZE AWG No.	Resistance at 20° C (68° F) ohms per 1000 Feet
18	6.39
16	4.02
14	2.52
12	1.59
10	1.00
8	0.63
6	0.40
4	0.25

GROUND WIRE	CONTROL WIRE						
	18	16	14	12	10	8	6
18	850	1040	1210	1350	1460	1540	1590
16	1040	1340	1650	1920	2150	2330	2440
14	1210	1650	2150	2630	3080	3450	3700
12	1350	1920	2630	3390	4170	4880	5400
10	1460	2150	3080	4170	5400	6670	7690
8	1540	2330	3450	4880	6670	8700	10530
6	1590	2440	3700	5400	7690	10530	13330

Solenoid: 24VAC, Pressure: 150 PSI, Voltage Drop: 4V, Min. Operating Voltage: 20V, Amperage Peak: .37A

	(U.S.)	(METRIC)
Equilateral Triangular Spacing	P.R.= (in/hr) $\frac{(GPM \text{ of } 360) \times 96.25}{(\text{Head Spacing})^2 \times .866}$	P.R.= (mm/hr) $\frac{m3/hr \text{ of } 360 \times 1000}{m2 \times .866}$
Square/Rectangular Spacing	P.R.= (in/hr) $\frac{(GPM \text{ of } 360) \times 96.25}{\text{Head Spacing} \times \text{Row Spacing}}$	P.R.= (mm/hr) $\frac{m3/hr \text{ of } 360 \times 1000}{\text{Head Spacing} \times \text{Row Spacing}}$
Square/Rectangular Spacing for Specific Arc	P.R.= (in/hr) $\frac{3460 \times GPM \text{ (for any arc)}}{\text{Degrees of Arc} \times \text{Head Spacing} \times \text{Row Spacing}}$	P.R.= (mm/hr) $\frac{m3/hr \text{ (for any arc)} \times 1000}{\text{Degrees of Arc} \times \text{Head Spacing} \times \text{Row Spacing}}$
Horsepower	H.P. = $\frac{GPM \times Ft \text{ of Head}}{3,960 \times \text{Pump Efficiency (expressed as a decimal)}}$	
Station Run Time	S.R.T. = (min/wk) $\frac{\text{Total Weekly Req'd (inch/wk)} \times 60 \text{ (min/hr)}}{\text{Precipitation Rate (in/hr)}}$	S.R.T.= (min/wk) $\frac{\text{Total Weekly Req'd (mm/wk)} \times 60 \text{ (min/hr)}}{\text{Precipitation Rate (mm/hr)}}$
Pipe Velocity	V= (ft/sec) $\frac{0.4085 \times \text{Flow (GPM)}}{(\text{Inside Pipe Diameter in Inches})^2}$	V= (m/sec) $\frac{1273.24 \times \text{Flow (l/sec)}}{(\text{Inside Pipe Diameter in Millimeters})^2}$
Scheduling Coefficient	S.C.= $\frac{\text{Average Precipitation Rate (in/hr)}}{\text{Lowest Precipitation Rate (in/hr)}}$	S.C.= $\frac{\text{Average Precipitation Rate (mm/hr)}}{\text{Lowest Precipitation Rate (mm/hr)}}$
Slope	S= $\frac{\text{Rise (Measure of Length)}}{\text{Run (Measure of Length)}}$	

PVC Schedule 40 IPS Plastic Pipe

SIZES: 1/2" - 6" **FLOW:** 1 - 600 GPM **PSI LOSS:** Per 100' of tube (PSI/100 FT) **C = 150** (1120, 1220)

SIZE	1/2"		3/4"		1"		1 1/4"		1 1/2"		2"		2 1/2"		3"		4"		6"	
OD	0.840		1.050		1.315		1.660		1.900		2.375		2.875		3.500		4.500		6.625	
ID	0.622		0.824		1.049		1.380		1.610		2.067		2.469		3.068		4.026		6.065	
WALL THK.	0.109		0.113		0.133		0.140		0.145		0.154		0.203		0.216		0.237		0.280	
FLOW G. P. M.	Velocity FPS	psi Loss	Velocity FPS	psi Loss	Velocity FPS	psi Loss	Velocity FPS	psi Loss	Velocity FPS	psi Loss	Velocity FPS	psi Loss	Velocity FPS	psi Loss	Velocity FPS	psi Loss	Velocity FPS	psi Loss	Velocity FPS	psi Loss
1	1.05	0.43	0.60	0.11	0.37	0.03	0.21	0.01	0.15	0.00										
2	2.11	1.55	1.20	0.39	0.74	0.12	0.42	0.03	0.31	0.02	0.19	0.00								
3	3.16	3.28	1.80	0.84	1.11	0.26	0.64	0.07	0.47	0.03	0.28	0.01	0.20	0.00						
4	4.22	5.60	2.40	1.42	1.48	0.44	0.85	0.12	0.62	0.05	0.38	0.02	0.26	0.01						
5	5.27	8.46	3.00	2.15	1.85	0.66	1.07	0.18	0.78	0.08	0.47	0.02	0.33	0.01	0.21	0.00				
6	6.33	11.86	3.60	3.02	2.22	0.93	1.28	0.25	0.94	0.12	0.57	0.03	0.40	0.01	0.26	0.01				
7	7.38	15.77	4.20	4.01	2.59	1.24	1.49	0.33	1.10	0.15	0.66	0.05	0.46	0.02	0.30	0.01				
8	8.44	20.20	4.80	5.14	2.96	1.59	1.71	0.42	1.25	0.20	0.76	0.06	0.53	0.02	0.34	0.01				
9	9.49	25.12	5.40	6.39	3.33	1.97	1.92	0.52	1.41	0.25	0.85	0.07	0.60	0.03	0.39	0.01				
10	10.55	30.54	6.00	7.77	3.70	2.40	2.14	0.63	1.57	0.30	0.95	0.09	0.66	0.04	0.43	0.01				
11	11.60	36.43	6.60	9.27	4.07	2.86	2.35	0.75	1.73	0.36	1.05	0.11	0.73	0.04	0.47	0.02				
12	12.65	42.80	7.21	10.89	4.44	3.36	2.57	0.89	1.88	0.42	1.14	0.12	0.80	0.05	0.52	0.02	0.30	0.00		
14	14.76	56.94	8.41	14.48	5.19	4.47	2.99	1.18	2.20	0.56	1.33	0.17	0.93	0.07	0.60	0.02	0.35	0.01		
16	16.87	72.92	9.61	18.55	5.93	5.73	3.42	1.51	2.51	0.71	1.52	0.21	1.07	0.09	0.69	0.03	0.40	0.01		
18	18.98	90.69	10.81	23.07	6.67	7.13	3.85	1.88	2.83	0.89	1.71	0.26	1.20	0.11	0.78	0.04	0.45	0.01		
20	21.09	110.23	12.01	28.04	7.41	8.66	4.28	2.28	3.14	1.08	1.90	0.32	1.33	0.13	0.86	0.05	0.50	0.01		
22			13.21	33.45	8.15	10.33	4.71	2.72	3.46	1.29	2.10	0.38	1.47	0.16	0.95	0.06	0.55	0.01		
24			14.42	39.30	8.89	12.14	5.14	3.20	3.77	1.51	2.29	0.45	1.60	0.19	1.04	0.07	0.60	0.02		
26			15.62	45.58	9.64	14.08	5.57	3.17	4.09	1.75	2.48	0.52	1.74	0.22	1.12	0.08	0.65	0.02		
28			16.82	52.28	10.38	16.15	5.99	4.25	4.40	2.01	2.67	0.60	1.87	0.25	1.21	0.09	0.70	0.02		
30			18.02	59.41	11.12	18.35	6.42	4.83	4.72	2.28	2.86	0.68	2.00	0.29	1.30	0.10	0.75	0.03		
35					12.97	24.42	7.49	6.43	5.50	3.04	3.34	0.90	2.34	0.38	1.51	0.13	0.88	0.04	0.38	0.00
40					14.83	31.27	8.56	8.23	6.29	3.89	3.81	1.15	2.67	0.49	1.73	0.17	1.00	0.04	0.44	0.01
45					16.68	38.89	9.64	10.24	7.08	4.84	4.29	1.43	3.01	0.60	1.95	0.21	1.13	0.06	0.49	0.01
50					18.53	47.27	10.71	12.45	7.87	5.88	4.77	1.74	3.34	0.73	2.16	0.26	1.25	0.07	1.55	0.01
55							11.78	14.85	8.65	7.01	5.25	2.08	3.68	0.88	2.38	0.30	1.38	0.08	0.61	0.01
60							12.85	17.45	9.44	8.24	5.72	2.44	4.01	1.03	2.60	0.36	1.51	0.10	0.66	0.01
65							13.92	20.23	10.23	9.56	6.20	2.83	4.35	1.19	2.81	0.41	1.63	0.11	0.72	0.02
70							14.99	23.21	11.01	10.96	6.68	3.25	4.68	1.37	3.03	0.48	1.76	0.13	0.77	0.02
75							16.06	26.37	11.80	12.46	7.16	3.69	5.01	1.56	3.25	0.54	1.88	0.14	0.83	0.02
80							17.13	29.72	12.59	14.04	7.63	4.16	5.35	1.75	3.46	0.61	2.01	0.16	0.88	0.02
85							18.21	33.26	13.37	15.71	8.11	4.66	5.68	1.96	3.68	0.68	2.13	0.18	0.94	0.02
90							19.28	36.97	14.16	17.46	8.59	5.18	6.02	2.18	3.90	0.76	2.26	0.20	0.99	0.03
95									14.95	19.30	9.07	5.72	6.35	2.41	4.11	0.84	2.39	0.22	1.05	0.03
100									15.74	21.22	9.54	6.29	6.69	2.65	4.33	0.92	2.51	0.25	1.10	0.03
110									17.31	25.32	10.50	7.51	7.36	3.16	4.76	1.10	2.76	0.29	1.22	0.04
120									18.88	29.75	11.45	8.82	8.03	3.72	5.20	1.29	3.02	0.34	1.33	0.05
130											12.41	10.23	8.70	4.31	5.63	1.50	3.27	0.40	1.44	0.05
140											13.36	11.74	9.37	4.94	6.06	1.72	3.52	0.46	1.55	0.06
150											14.32	13.33	10.03	5.62	6.50	1.95	3.77	0.52	1.66	0.07
160											15.27	15.03	10.70	6.33	6.93	2.20	4.02	0.59	1.77	0.08
170											16.23	16.81	11.37	7.08	7.36	2.46	4.27	0.66	1.88	0.09
180											17.18	18.69	12.04	7.87	7.80	2.74	4.53	0.73	1.99	0.10
190											18.14	20.66	12.71	8.70	8.23	3.02	4.78	0.81	2.10	0.11
200											19.09	22.72	13.38	9.57	8.66	3.33	5.03	0.89	2.21	0.12
225													15.05	11.90	9.75	4.14	5.66	1.10	2.49	0.15
250													16.73	14.47	10.83	5.03	6.29	1.34	2.77	0.18
275													18.40	17.26	11.92	6.00	6.92	1.60	3.05	0.22
300															13.00	7.05	7.55	1.88	3.32	0.26
325															14.08	8.17	8.18	2.18	3.60	0.30
350															15.17	9.38	8.81	2.50	3.88	0.34
375															16.25	10.65	9.43	2.84	4.15	0.39
400															17.33	12.01	10.06	3.20	4.43	0.44
425															18.42	13.43	10.69	3.58	4.71	0.49
450															19.50	14.93	11.32	3.98	4.99	0.54
475																	11.95	4.40	5.26	0.60
500																	12.58	4.84	5.54	0.66
550																	13.84	5.77	6.10	0.79
600																	15.10	6.78	6.65	0.92

Note: Shaded areas of the chart indicate velocities over 5 feet per second (FPS). Use with caution.

Charts

PVC Schedule 80 IPS Plastic Pipe

SIZES: 1/2" – 6" **FLOW:** 1 – 600 GPM **PSI LOSS:** Per 100' of tube (PSI/100 FT) **C =** 150 (1120, 1220)

SIZE	1/2"		3/4"		1"		1 1/4"		1 1/2"		2"		2 1/2"		3"		4"		6"	
OD	0.840		1.050		1.315		1.660		1.900		2.375		2.875		3.500		4.500		6.625	
ID	0.546		0.742		0.957		1.278		1.500		1.939		2.323		2.900		3.826		5.761	
WALL THK.	0.147		0.154		0.179		0.191		0.200		0.218		0.276		0.300		0.337		0.432	
FLOW G. P. M.	Velocity FPS	psi Loss	Velocity FPS	psi Loss	Velocity FPS	psi Loss	Velocity FPS	psi Loss	Velocity FPS	psi Loss	Velocity FPS	psi Loss	Velocity FPS	psi Loss	Velocity FPS	psi Loss	Velocity FPS	psi Loss	Velocity FPS	psi Loss
1	1.36	0.81	0.74	0.18	0.44	0.05	0.24	0.01	0.18	0.01	0.10	0.00								
2	2.73	2.92	1.48	0.66	0.89	0.19	0.49	0.05	0.36	0.02	0.21	0.01	0.15	0.00						
3	4.10	6.19	2.22	1.39	1.33	0.40	0.74	0.10	0.54	0.05	0.32	0.01	0.22	0.01						
4	5.47	10.54	2.96	2.37	1.78	0.69	0.99	0.17	0.72	0.08	0.43	0.02	0.30	0.01						
5	6.84	15.93	3.70	3.58	2.22	1.04	1.24	0.25	0.90	0.12	0.54	0.03	0.37	0.01	0.24	0.00				
6	8.21	22.33	4.44	5.02	2.67	1.46	1.49	0.36	1.08	0.16	0.65	0.05	0.45	0.02	0.29	0.01				
7	9.58	29.71	5.18	6.68	3.11	1.94	1.74	0.47	1.26	0.22	0.75	0.06	0.52	0.03	0.33	0.01				
8	10.94	38.05	5.92	8.56	3.56	2.48	1.99	0.61	1.45	0.28	0.86	0.08	0.60	0.03	0.38	0.01				
9	12.31	47.33	6.66	10.64	4.00	3.09	2.24	0.76	1.63	0.35	0.97	0.10	0.68	0.04	0.43	0.01				
10	13.68	57.52	7.41	12.93	4.45	3.75	2.49	0.92	1.81	0.42	1.08	0.12	0.75	0.05	0.48	0.02	0.27	0.00		
11	15.05	68.63	8.15	15.43	4.90	4.47	2.74	1.10	1.99	0.50	1.19	0.14	0.83	0.06	0.53	0.02	0.30	0.01		
12	16.42	80.63	8.89	18.13	5.34	5.26	2.99	1.29	2.17	0.59	1.30	0.17	0.90	0.07	0.58	0.02	0.33	0.01		
14			10.37	24.12	6.23	6.99	3.49	1.71	2.53	0.79	1.51	0.23	1.05	0.09	0.67	0.03	0.39	0.01		
16			11.85	30.88	7.12	8.95	3.99	2.19	2.90	1.01	1.73	0.29	1.20	0.12	0.77	0.04	0.44	0.01		
18			13.33	38.41	8.01	11.14	4.49	2.73	3.26	1.26	1.95	0.36	1.36	0.15	0.87	0.05	0.50	0.01		
20			14.82	46.69	8.90	13.54	4.99	3.31	3.62	1.52	2.17	0.44	1.51	0.18	0.97	0.06	0.55	0.02		
22			16.30	55.70	9.80	16.15	5.49	3.95	3.98	1.81	2.38	0.52	1.66	0.22	1.06	0.07	0.61	0.02		
24			17.78	65.44	10.69	18.97	5.99	4.64	4.35	2.13	2.60	0.61	1.81	0.25	1.16	0.09	0.66	0.02		
26			19.26	75.90	11.58	22.01	6.49	5.39	4.71	2.47	2.82	0.71	1.96	0.29	1.26	0.10	0.72	0.03		
28			12.47	25.24	6.99	6.18	5.07	2.83	3.03	0.81	2.11	0.34	1.35	0.11	0.78	0.03				
30					13.36	28.69	7.49	7.02	5.43	3.22	3.25	0.92	2.26	0.38	1.45	0.13	0.83	0.03	0.36	0.00
35					15.59	38.16	8.74	9.34	6.34	4.29	3.79	1.23	2.64	0.51	1.69	0.17	0.97	0.05	0.43	0.01
40					17.81	48.87	9.99	11.96	7.25	5.49	4.34	1.57	3.02	0.65	1.94	0.22	1.11	0.06	0.49	0.01
45							11.24	14.88	8.16	6.83	4.88	1.96	3.40	0.81	2.18	0.28	1.25	0.07	0.55	0.01
50							12.49	18.09	9.06	8.30	5.42	2.38	3.78	0.99	2.42	0.34	1.39	0.09	0.61	0.01
55							13.73	21.58	9.97	9.90	5.96	2.84	4.15	1.18	2.66	0.40	1.53	0.10	0.67	0.01
60							14.98	25.35	10.87	11.63	6.51	3.33	4.53	1.38	2.91	0.47	1.67	0.12	0.73	0.02
65							16.23	29.40	11.78	13.49	7.05	3.87	4.91	1.61	3.15	0.55	1.81	0.14	0.79	0.02
70							17.48	33.72	12.69	15.47	7.59	4.44	5.29	1.84	3.39	0.63	1.95	0.16	0.86	0.02
75							18.73	38.32	13.59	17.58	8.13	5.04	5.67	2.09	3.63	0.71	2.09	0.18	0.92	0.03
80							19.98	43.19	14.50	19.81	8.68	5.68	6.04	2.36	3.88	0.80	2.22	0.21	0.98	0.03
85									15.41	22.16	9.22	6.36	6.42	2.63	4.12	0.90	2.36	0.23	1.04	0.03
90									16.32	24.64	9.76	7.07	6.80	2.93	4.36	1.00	2.50	0.26	1.10	0.04
95									17.22	27.23	10.30	7.81	7.18	3.24	4.60	1.10	2.64	0.29	1.16	0.04
100									18.13	29.95	10.85	8.59	7.56	3.57	4.85	1.21	2.78	0.31	1.22	0.04
110									19.94	35.73	11.93	10.25	8.31	4.25	5.33	1.45	3.06	0.38	1.35	0.05
120											13.02	12.04	9.07	5.00	5.82	1.70	3.34	0.44	1.47	0.06
130											14.10	13.96	9.82	5.60	6.30	1.97	3.62	0.51	1.59	0.07
140											15.19	16.02	10.58	6.65	6.79	2.27	3.90	0.59	1.72	0.08
150											16.27	18.20	11.34	7.56	7.27	2.57	4.18	0.67	1.84	0.09
160											17.36	20.51	12.09	8.51	7.76	2.89	4.45	0.75	1.96	0.10
170											18.44	22.95	12.85	9.53	8.24	3.24	4.73	0.84	2.08	0.11
180											19.53	25.51	13.60	10.59	8.73	3.60	5.01	0.93	2.21	0.13
190													14.36	11.71	9.21	3.98	5.29	1.03	2.33	0.14
200													15.12	12.87	9.70	4.37	5.57	1.14	2.45	0.16
225													17.01	16.01	10.91	5.44	6.27	1.41	2.76	0.19
250													18.90	19.46	12.12	6.61	6.96	1.72	3.07	0.23
275															13.34	7.89	7.66	2.05	3.38	0.28
300																	14.55	9.27	8.36	2.41
325																	15.76	10.75	9.05	2.79
350																	16.97	12.33	9.75	3.20
375																	18.19	14.01	10.45	3.64
400																	19.40	15.79	11.14	4.10
425																			11.84	4.59
450																			12.54	5.10
475																			13.23	5.64
500																			13.93	6.20
550																			15.32	7.40
600																			16.72	8.69

Note: Shaded areas of the chart indicate velocities over 5 feet per second (FPS). Use with caution.

Velocity of flow rate values are computed from the general equation $V = .408 Q/d^2$

Friction pressure loss values are computed from the equation $[hf = 0.2083 (100/C) 1.852 Q^{1.852}/d^{4.868}] \times 4.33$ for psi loss per 100' of pipe.

PVC Class 125 IPS Plastic Pipe

SIZES: 1" - 6" **FLOW:** 1 - 600 GPM **PSI LOSS:** Per 100' of tube (PSI/100 FT) **C = 150** (1120, 1220) SDR 32.5

SIZE	1"		1 1/4"		1 1/2"		2"		2 1/2"		3"		4"		6"	
OD	1.315		1.660		1.900		2.375		2.875		3.500		4.500		6.625	
ID	1.211		1.548		1.784		2.229		2.699		3.284		4.224		6.217	
WALL THK.	0.052		0.056		0.058		0.073		0.088		0.108		0.138		0.204	
FLOW G. P. M.	Velocity FPS	psi Loss	Velocity FPS	psi Loss	Velocity FPS	psi Loss	Velocity FPS	psi Loss	Velocity FPS	psi Loss	Velocity FPS	psi Loss	Velocity FPS	psi Loss	Velocity FPS	psi Loss
1	0.27	0.02	0.17	0.01	0.12	0.00										
2	0.55	0.06	0.34	0.02	0.25	0.01	0.16	0.00								
3	0.83	0.13	0.51	0.04	0.38	0.02	0.24	0.01								
4	1.11	0.22	0.68	0.07	0.51	0.03	0.32	0.01	0.22	0.00						
5	1.39	0.33	0.85	0.10	0.64	0.05	0.41	0.02	0.28	0.01						
6	1.66	0.46	1.02	0.14	0.76	0.07	0.49	0.02	0.33	0.01						
7	1.94	0.62	1.19	0.19	0.89	0.09	0.57	0.03	0.39	0.01	0.26	0.00				
8	2.22	0.79	1.36	0.24	1.02	0.12	0.65	0.04	0.44	0.02	0.30	0.01				
9	2.50	0.98	1.53	0.30	1.15	0.15	0.73	0.05	0.50	0.02	0.34	0.01				
10	2.78	1.19	1.70	0.36	1.28	0.18	0.82	0.06	0.56	0.02	0.37	0.01				
11	3.06	1.42	1.87	0.43	1.41	0.22	0.90	0.07	0.61	0.03	0.41	0.01				
12	3.33	1.67	2.04	0.51	1.53	0.25	0.98	0.09	0.67	0.03	0.45	0.01	0.27	0.00		
14	3.89	2.22	2.38	0.67	1.79	0.34	1.14	0.11	0.78	0.05	0.52	0.02	0.32	0.01		
16	4.45	2.85	2.72	0.86	2.05	0.43	1.31	0.15	0.89	0.06	0.60	0.02	0.36	0.01		
18	5.00	3.54	3.06	1.07	2.30	0.54	1.47	0.18	1.00	0.07	0.68	0.03	0.41	0.01		
20	5.56	4.31	3.40	1.30	2.56	0.65	1.64	0.22	1.12	0.09	0.75	0.03	0.45	0.01		
22	6.12	5.14	3.74	1.56	2.82	0.78	1.80	0.26	1.23	0.10	0.83	0.04	0.50	0.01		
24	6.67	6.04	4.08	1.83	3.07	0.92	1.97	0.31	1.34	0.12	0.90	0.05	0.54	0.01		
26	7.23	7.00	4.42	2.12	3.33	1.06	2.13	0.36	1.45	0.14	0.98	0.05	0.59	0.02		
28	7.78	8.03	4.76	2.43	3.58	1.22	2.29	0.41	1.56	0.16	1.05	0.06	0.644	0.02		
30	8.34	9.13	5.10	2.76	3.84	1.39	2.46	0.47	1.68	0.18	1.13	0.07	0.68	0.02		
35	9.73	12.14	5.95	3.68	4.48	1.84	2.87	0.62	1.96	0.25	1.32	0.09	0.80	0.03	0.36	0.00
40	11.12	15.55	6.81	4.71	5.12	2.36	3.28	0.80	2.24	0.31	1.51	0.12	0.91	0.04	0.42	0.01
45	12.51	19.34	7.66	5.86	5.76	2.94	3.69	0.99	2.52	0.39	1.70	0.15	1.02	0.04	0.47	0.01
50	13.91	23.50	8.51	7.12	6.40	3.57	4.10	1.21	2.80	0.48	1.89	0.18	1.14	0.05	0.52	0.01
55	15.30	28.04	9.36	8.49	7.05	4.26	4.51	1.44	3.08	0.57	2.08	0.22	1.25	0.06	0.58	0.01
60	16.69	32.94	10.21	9.98	7.69	5.00	4.92	1.69	3.36	0.67	2.26	0.26	1.37	0.085	0.63	0.01
65	18.08	38.21	11.06	11.57	8.33	5.80	5.33	1.96	3.64	0.77	2.45	0.30	1.48	0.09	0.68	0.01
70	19.47	43.83	11.91	13.27	8.97	6.65	5.74	2.25	3.92	0.89	2.64	0.34	1.60	0.10	0.73	0.02
75			12.76	15.08	9.61	7.56	6.15	2.56	4.20	1.01	2.83	0.39	1.71	0.11	0.79	0.02
80			13.62	17.00	10.25	8.52	6.56	2.88	4.48	1.14	3.02	0.44	1.82	0.13	0.84	0.02
85			14.47	19.02	10.89	9.53	6.98	3.23	4.76	1.27	3.21	0.49	1.94	0.14	0.89	0.02
90			15.32	21.14	11.53	10.60	7.39	3.59	5.04	1.41	3.40	0.54	2.05	0.16	0.95	0.02
95			16.17	23.37	12.17	11.71	7.80	3.96	5.32	1.56	3.59	0.60	2.17	0.18	1.00	0.03
100			17.02	25.69	12.81	12.88	8.21	4.36	5.60	1.72	3.78	0.66	2.28	0.19	1.05	0.03
110			18.72	3.65	14.10	15.37	9.03	5.20	6.16	2.05	4.16	0.79	2.51	0.23	1.16	0.04
120					15.38	18.06	9.85	6.11	6.72	2.41	4.53	0.93	2.74	0.27	1.26	0.04
130					16.66	20.94	10.67	7.09	7.28	2.79	4.91	1.08	2.97	0.32	1.37	0.05
140					17.94	24.02	11.49	8.13	7.84	3.20	5.29	1.23	3.20	0.36	1.47	0.06
150					19.22	27.30	12.31	9.24	8.40	3.64	5.67	1.40	3.43	0.41	1.58	0.06
160							13.13	10.41	8.96	4.10	6.05	1.58	3.65	0.46	1.68	0.07
170							13.96	11.65	9.52	4.59	6.43	1.77	3.88	0.52	1.79	0.08
180							14.78	12.95	10.08	5.10	6.80	1.96	4.11	0.58	1.90	0.09
190							15.60	14.31	10.64	5.64	7.18	2.17	4.34	0.64	2.00	0.10
200							16.42	15.74	11.20	6.20	7.56	2.39	4.57	0.70	2.11	0.11
225							18.47	19.57	12.60	7.72	8.51	2.97	5.14	0.87	2.37	0.13
250									14.00	9.38	9.45	3.61	5.71	1.06	2.63	0.16
275									15.40	11.19	10.40	4.31	6.28	1.27	2.90	0.19
300									16.80	13.15	11.34	5.06	6.86	1.49	3.16	0.23
325									18.20	15.25	12.29	5.87	7.43	1.72	3.43	0.26
350									19.60	17.49	13.24	6.73	8.00	1.98	3.69	0.30
375											14.18	7.65	8.57	2.25	3.95	0.34
400											15.13	8.62	9.14	2.53	4.22	0.39
425											16.07	9.65	9.71	2.83	4.48	0.43
450											17.02	10.72	10.29	3.15	4.75	0.48
475											17.96	11.85	10.86	3.48	5.01	0.53
500											18.91	13.03	11.43	3.83	5.27	0.58
550													12.57	4.57	5.80	0.70
600													13.72	5.37	6.33	0.82

Note: Shaded areas of the chart indicate velocities over 5 feet per second (FPS). Use with caution.

Charts

PVC Class 160 IPS Plastic Pipe

SIZES: 1" – 6" **FLOW:** 1 – 600 GPM **PSI LOSS:** Per 100' of tube (PSI/100 FT) **C = 150** (1120, 1220) SDR 26

SIZE	1"		1 1/4"		1 1/2"		2"		2 1/2"		3"		4"		6"	
OD	1.315	1.660	1.900	2.375	2.875	3.500	4.500	6.625								
ID	1.195	1.532	1.754	2.193	2.655	3.230	4.154	6.115								
WALL THK.	0.060	0.064	0.073	0.091	0.110	0.135	0.173	0.225								
FLOW G. P. M.	Velocity FPS	psi Loss	Velocity FPS	psi Loss	Velocity FPS	psi Loss	Velocity FPS	psi Loss	Velocity FPS	psi Loss	Velocity FPS	psi Loss	Velocity FPS	psi Loss	Velocity FPS	psi Loss
1	0.28	0.02	0.17	0.01	0.13	0.00										
2	0.57	0.06	0.34	0.02	0.26	0.01	0.16	0.00								
3	0.85	0.14	0.52	0.04	0.39	0.02	0.25	0.01								
4	1.14	0.23	0.69	0.07	0.53	0.04	0.33	0.01	0.23	0.00						
5	1.42	0.35	0.86	0.11	0.66	0.05	0.42	0.02	0.28	0.01						
6	1.71	0.49	1.04	0.15	0.79	0.08	0.50	0.03	0.34	0.01	0.20	0.00				
7	1.99	0.66	1.21	0.20	0.92	0.10	0.59	0.03	0.40	0.01	0.27	0.01				
8	2.28	0.84	1.39	0.25	1.06	0.13	0.67	0.04	0.46	0.02	0.31	0.01				
9	2.57	1.05	1.56	0.31	1.19	0.16	0.76	0.05	0.52	0.02	0.35	0.01				
10	2.85	1.27	1.73	0.38	1.32	0.20	0.84	0.07	0.57	0.03	0.39	0.01				
11	3.14	1.52	1.91	0.45	1.45	0.23	0.93	0.08	0.63	0.03	0.43	0.01				
12	3.42	1.78	2.085	0.53	1.59	0.28	1.01	0.09	0.69	0.04	0.46	0.01	0.28	0.00		
14	3.99	2.37	2.43	0.71	1.85	0.37	1.18	0.12	0.81	0.05	0.54	0.02	0.33	0.01		
16	4.57	3.04	2.78	0.91	2.12	0.47	1.35	0.16	0.92	0.06	0.62	0.02	0.37	0.01		
18	5.14	3.78	3.12	1.13	2.38	0.58	1.52	0.20	1.04	0.08	0.70	0.03	0.42	0.01		
20	5.71	4.59	3.47	1.37	2.65	0.71	1.69	0.24	1.15	0.09	0.78	0.04	0.47	0.01		
22	6.28	5.48	3.82	1.64	2.91	0.85	1.86	0.29	1.27	0.11	0.86	0.04	0.52	0.01		
24	6.85	6.44	4.17	1.92	3.18	1.00	2.03	0.34	1.38	0.13	0.93	0.05	0.56	0.02		
26	7.42	7.47	4.51	2.23	3.44	1.15	2.20	0.39	1.50	0.15	1.01	0.06	0.61	0.02		
28	7.99	8.57	4.86	2.56	3.71	1.32	2.37	0.45	1.62	0.18	1.09	0.07	0.66	0.02		
30	8.57	9.74	5.21	2.91	3.97	1.50	2.54	0.51	1.73	0.20	1.17	0.08	0.70	0.02		
35	9.99	12.95	6.08	3.87	4.64	2.00	2.96	0.68	2.02	0.27	1.36	0.10	0.82	0.03	0.38	0.00
40	11.42	16.59	6.95	4.95	5.30	2.56	3.39	0.86	2.31	0.34	1.56	0.13	0.94	0.04	0.43	0.01
45	12.85	20.63	7.82	6.16	5.96	3.19	3.81	1.08	2.60	0.42	1.75	0.16	1.06	0.05	0.49	0.01
50	14.28	25.07	8.69	7.49	6.63	3.88	4.24	1.31	2.89	0.52	1.95	0.20	1.18	0.06	0.54	0.01
55	15.71	29.91	9.56	8.93	7.29	4.62	4.66	1.56	3.18	0.62	2.15	0.24	1.30	0.07	0.60	0.01
60	17.14	35.14	10.43	10.49	7.95	5.43	5.09	1.83	3.47	0.72	2.34	0.28	1.41	0.08	0.65	0.01
65	18.57	40.67	11.29	12.17	8.62	6.30	5.51	2.12	3.76	0.84	2.54	0.32	1.53	0.09	0.70	0.01
70	19.99	46.76	12.16	13.96	9.28	7.23	5.93	2.44	4.05	0.96	2.73	0.37	1.65	0.11	0.76	0.02
75			13.03	15.86	9.94	8.21	6.36	2.77	4.34	1.09	2.93	0.42	1.77	0.12	0.81	0.02
80			13.90	17.88	10.60	9.25	6.78	3.12	4.63	1.23	3.12	0.47	1.89	0.14	0.87	0.02
85			14.77	20.00	11.27	10.35	7.21	3.49	4.91	1.38	3.32	0.53	2.00	0.16	0.92	0.02
90			15.64	22.23	11.93	11.51	7.63	3.88	5.20	1.53	3.51	0.59	2.12	0.17	0.98	0.03
95			16.51	24.58	12.59	12.72	8.05	4.29	5.49	1.69	3.71	0.65	2.24	0.19	1.03	0.03
100			17.38	27.03	13.26	13.99	8.48	4.72	5.78	1.86	3.91	0.72	2.36	0.21	1.09	0.03
110			19.12	32.24	14.58	16.69	9.33	5.63	6.36	2.22	4.30	0.86	2.60	0.25	1.20	0.04
120					15.91	19.61	10.18	6.61	6.94	2.61	4.69	1.01	2.83	0.30	1.30	0.05
130					17.24	22.74	11.02	7.67	7.52	3.03	5.08	1.17	3.07	0.34	1.41	0.05
140					18.56	26.09	11.87	8.80	8.10	3.47	5.47	1.34	3.31	0.39	1.52	0.06
150					19.89	29.64	12.72	10.00	8.68	3.94	5.86	1.52	3.54	0.45	1.63	0.07
160							13.57	11.27	9.26	4.45	6.25	1.71	3.78	0.50	1.74	0.08
170							14.42	12.61	9.83	4.97	6.64	1.92	4.01	0.56	1.85	0.09
180							15.27	14.02	10.41	5.53	7.03	2.13	4.25	0.63	1.96	0.10
190							16.11	15.49	10.99	6.11	7.43	2.35	4.49	0.69	2.07	0.11
200							16.96	17.03	11.57	6.72	7.82	2.59	4.72	0.76	2.18	0.12
225							19.08	21.19	13.02	8.36	8.79	3.22	5.31	0.95	2.45	0.14
250									14.47	10.16	9.77	3.91	5.91	1.15	2.72	0.18
275									15.91	12.12	10.75	4.67	6.50	1.37	3.00	0.21
300									17.36	14.24	11.73	5.49	7.09	1.61	3.27	0.25
325									18.81	16.51	12.70	6.36	7.68	1.87	3.54	0.29
350											13.68	7.30	8.27	2.15	3.81	0.33
375											14.66	8.29	8.86	2.44	4.09	0.37
400											15.64	9.35	9.45	2.75	4.36	0.42
425											16.62	10.46	10.04	3.07	4.63	0.47
450											17.59	11.62	10.63	3.42	4.90	0.52
475											18.57	12.85	11.23	3.78	5.18	0.58
500											19.55	14.13	11.82	4.15	5.45	0.63
550													13.00	4.96	6.00	0.76
600													14.18	5.82	6.54	0.89

Note: Shaded areas of the chart indicate velocities over 5 feet per second (FPS). Use with caution.

PVC Class 200 IPS Plastic Pipe

SIZES: 3/4" – 6" **FLOW:** 1 – 600 GPM **PSI LOSS:** Per 100' of pipe (PSI/100 FT) **C = 150** (1120, 1220) SDR 21

SIZE	3/4"		1"		1 1/4"		1 1/2"		2"		2 1/2"		3"		4"		6"	
OD	1.050	1.315	1.660	1.900	2.375	2.875	3.500	4.500	6.625									
ID	0.930	1.189	1.502	1.720	2.149	2.601	3.166	4.072	5.993									
WALL THK.	0.060	0.063	0.079	0.090	0.113	0.137	0.167	0.214	0.316									
FLOW G. P. M.	Velocity FPS	psi Loss	Velocity FPS	psi Loss	Velocity FPS	psi Loss	Velocity FPS	psi Loss	Velocity FPS	psi Loss	Velocity FPS	psi Loss	Velocity FPS	psi Loss	Velocity FPS	psi Loss	Velocity FPS	psi Loss
1	0.47	0.06	0.28	0.02	0.18	0.01	0.13	0.00										
2	0.94	0.22	0.57	0.07	0.36	0.02	0.27	0.01	0.17	0.00								
3	1.42	0.46	0.86	0.14	0.54	0.04	0.41	0.02	0.26	0.01	0.18	0.00						
4	1.89	0.79	1.15	0.24	0.72	0.08	0.55	0.04	0.35	0.01	0.24	0.01						
5	2.36	1.20	1.44	0.36	0.90	0.12	0.68	0.06	0.44	0.02	0.30	0.01						
6	2.83	1.68	1.73	0.51	1.08	0.16	0.82	0.08	0.53	0.03	0.36	0.01	0.24	0.00				
7	3.30	2.23	2.02	0.67	1.26	0.22	0.96	0.11	0.61	0.04	0.42	0.01	0.28	0.01				
8	3.77	2.85	2.30	0.86	1.44	0.28	1.10	0.14	0.70	0.05	0.48	0.02	0.32	0.01				
9	4.25	3.55	2.59	1.07	1.62	0.34	1.24	0.18	0.79	0.06	0.54	0.02	0.36	0.01				
10	4.72	4.31	2.88	1.30	1.80	0.42	1.37	0.22	0.88	0.07	0.60	0.03	0.40	0.01				
11	5.19	5.15	3.17	1.56	1.98	0.50	1.51	0.26	0.97	0.09	0.66	0.03	0.44	0.01				
12	5.66	6.05	3.46	1.83	2.17	0.59	1.65	0.30	1.06	0.10	0.72	0.04	0.48	0.02	0.29	0.00		
14	6.60	8.05	4.04	2.43	2.53	0.78	1.93	0.40	1.23	0.14	0.84	0.05	0.56	0.02	0.34	0.01		
16	7.55	10.30	4.61	3.11	2.89	1.00	2.20	0.52	1.41	0.17	0.96	0.07	0.65	0.03	0.39	0.01		
18	8.49	12.81	5.19	3.87	3.25	1.24	2.48	0.64	1.59	0.22	1.08	0.09	0.73	0.03	0.44	0.01		
20	9.43	15.58	5.77	4.71	3.61	1.51	2.75	0.78	1.76	0.26	1.20	0.10	0.81	0.04	0.49	0.01		
22	10.38	18.58	6.34	5.62	3.97	1.80	3.03	0.93	1.94	0.32	1.32	0.12	0.89	0.05	0.54	0.01		
24	11.32	21.83	6.92	6.60	4.34	2.12	3.30	1.09	2.12	0.37	1.44	0.15	0.97	0.06	0.59	0.02		
26	12.27	25.32	7.50	7.65	4.70	2.46	3.58	1.27	2.29	0.43	1.56	0.17	1.05	0.07	0.63	0.02		
28	13.21	29.04	8.08	8.78	5.06	2.82	3.86	1.46	2.47	0.49	1.68	0.19	1.13	0.07	0.68	0.02		
30	14.15	33.00	8.65	9.98	5.42	3.20	4.13	1.66	2.65	0.56	1.80	0.22	1.22	0.09	0.73	0.02	0.34	0.00
35	16.51	43.91	10.10	13.27	6.32	4.26	4.82	2.20	3.09	0.75	2.11	0.29	1.42	0.11	0.86	0.03	0.39	0.01
40	18.87	56.23	11.54	17.00	7.23	5.45	5.51	2.82	3.53	0.95	2.41	0.38	1.62	0.14	0.98	0.04	0.45	0.01
45			12.98	21.14	8.13	6.78	6.20	3.51	3.97	1.19	2.71	0.47	1.83	0.18	1.10	0.05	0.51	0.01
50			14.42	25.70	9.04	8.24	6.89	4.26	4.41	1.44	3.01	0.57	2.03	0.22	1.23	0.06	0.56	0.01
55			15.87	30.66	9.94	9.83	7.58	5.09	4.85	1.72	3.31	0.68	2.23	0.26	1.35	0.08	0.62	0.01
60			17.31	36.02	10.85	11.55	8.27	5.97	5.30	2.02	3.61	0.80	2.44	0.31	1.47	0.09	0.68	0.01
65			18.75	41.77	11.75	13.40	8.96	6.93	5.74	2.35	3.92	0.93	2.64	0.36	1.59	0.10	0.73	0.02
70					12.65	15.37	9.65	7.95	6.18	2.69	4.22	1.06	2.84	0.41	1.72	0.12	0.79	0.02
75					13.56	17.47	10.34	9.03	6.62	3.06	4.52	1.21	3.05	0.46	1.84	0.14	0.85	0.02
80					14.46	19.68	11.03	10.18	7.06	3.44	4.82	1.36	3.25	0.52	1.96	0.15	0.90	0.02
85					15.37	22.02	11.72	11.39	7.50	3.85	5.12	1.52	3.45	0.59	2.09	0.17	0.96	0.03
90					16.27	24.48	12.41	12.66	7.95	4.28	5.42	1.69	3.66	0.65	2.21	0.19	1.02	0.03
95					17.18	27.06	13.10	13.99	8.39	4.74	5.72	1.87	3.86	0.72	2.33	0.21	1.07	0.03
100					18.08	29.76	13.79	15.39	8.83	5.21	6.03	2.06	4.07	0.79	2.46	0.23	1.13	0.04
110					19.89	35.50	15.17	18.36	9.71	6.21	6.63	2.45	4.47	0.94	2.70	0.28	1.24	0.04
120							16.54	21.57	10.60	7.30	7.23	2.88	4.88	1.11	2.95	0.33	1.36	0.05
130							17.92	25.02	11.48	8.47	7.84	3.34	5.29	1.29	3.19	0.38	1.47	0.06
140							19.30	28.70	12.36	9.71	8.44	3.84	5.69	1.47	3.44	0.43	1.59	0.07
150									13.25	11.04	9.04	4.36	6.10	1.68	3.69	0.49	1.70	0.08
160									14.13	12.44	9.64	4.91	6.51	1.89	3.93	0.55	1.81	0.08
170									15.01	13.91	10.25	5.50	6.91	2.11	4.18	0.62	1.93	0.09
180									15.90	15.47	10.85	6.11	7.32	2.35	4.42	0.69	2.04	0.11
190									16.78	17.10	11.45	6.75	7.73	2.60	4.67	0.76	2.15	0.12
200									17.66	18.80	12.06	7.43	8.14	2.85	4.92	0.84	2.27	0.13
225									19.87	23.38	13.56	9.24	9.15	3.55	5.53	1.04	2.55	0.16
250											15.07	11.23	10.17	4.31	6.15	1.27	2.83	0.19
275											16.58	13.39	11.19	5.15	6.76	1.51	3.12	0.23
300											18.09	15.74	12.21	6.05	7.38	1.78	3.40	0.27
325											19.60	18.25	13.22	7.01	7.99	2.06	3.69	0.31
350													14.24	8.05	8.61	2.36	3.97	0.36
375													15.26	9.14	9.22	2.69	4.25	0.41
400													16.28	10.30	9.84	3.03	4.54	0.46
425													17.29	11.53	10.45	3.396	4.82	0.52
450													18.31	12.81	11.07	3.77	5.11	0.57
475													19.33	14.16	11.68	4.16	5.39	0.63
500															12.30	4.58	5.67	0.70
550															13.53	5.46	6.24	0.83
600															14.76	6.42	6.81	0.98

Note: Shaded areas of the chart indicate velocities over 5 feet per second (FPS). Use with caution.

Charts

PVC Class 315 IPS Plastic Pipe

SIZES: 1/2" - 6" **FLOW:** 1 - 600 GPM **PSI LOSS:** Per 100' of pipe (PSI/100 FT) **C = 150** (1120, 1220) SDR 13.5

SIZE	1/2"		3/4"		1"		1 1/4"		1 1/2"		2"		2 1/2"		3"		4"		6"	
OD	0.840		1.050		1.315		1.660		1.900		2.375		2.875		3.500		4.500		6.625	
ID	0.716		0.894		1.121		1.414		1.618		2.023		2.449		2.982		3.834		5.643	
WALL THK.	0.062		0.078		0.097		0.123		0.141		0.176		0.213		0.259		0.333		0.491	
FLOW G. P. M.	Velocity FPS	psi Loss	Velocity FPS	psi Loss	Velocity FPS	psi Loss	Velocity FPS	psi Loss	Velocity FPS	psi Loss	Velocity FPS	psi Loss	Velocity FPS	psi Loss	Velocity FPS	psi Loss	Velocity FPS	psi Loss	Velocity FPS	psi Loss
1	0.79	0.22	0.51	0.07	0.32	0.02	0.20	0.01	0.15	0.00										
2	1.59	0.78	1.02	0.27	0.64	0.09	0.40	0.03	0.31	0.01	0.19	0.00								
3	2.38	1.65	1.53	0.56	0.97	0.19	0.61	0.06	0.46	0.03	0.29	0.01	0.20	0.00						
4	3.18	2.82	2.04	0.96	1.29	0.32	0.81	0.10	0.62	0.05	0.39	0.02	0.27	0.01						
5	3.97	4.26	2.55	1.45	1.62	0.48	1.02	0.16	0.77	0.08	0.49	0.03	0.34	0.01	0.22	0.00				
6	4.77	5.97	3.06	2.03	1.94	0.67	1.22	0.22	0.93	0.11	0.59	0.04	0.40	0.02	0.27	0.01				
7	5.57	7.95	3.57	2.70	2.27	0.90	1.42	0.29	1.09	0.15	0.69	0.05	0.47	0.02	0.32	0.01				
8	6.36	10.18	4.08	3.45	2.59	1.15	1.63	0.37	1.24	0.19	0.79	0.06	0.54	0.03	0.36	0.01				
9	7.16	12.66	4.59	4.30	2.92	1.43	1.83	0.46	1.40	0.24	0.89	0.08	0.61	0.03	0.41	0.01				
10	7.95	15.38	5.10	5.22	3.24	1.74	2.04	0.56	1.55	0.29	0.99	0.10	0.68	0.04	0.45	0.01	0.27	0.00		
11	8.75	18.35	5.61	6.23	3.57	2.07	2.24	0.67	1.71	0.35	1.09	0.12	0.74	0.05	0.50	0.02	0.30	0.01		
12	9.55	21.56	6.12	7.32	3.89	2.43	2.44	0.79	1.87	0.41	1.19	0.14	0.81	0.05	0.55	0.02	0.33	0.01		
14	11.14	28.69	7.14	9.74	4.54	3.24	2.85	1.05	2.18	0.54	1.39	0.18	0.95	0.07	0.64	0.03	0.38	0.01		
16	12.73	36.74	8.16	12.47	5.19	4.15	3.26	1.34	2.49	0.70	1.59	0.23	1.08	0.09	0.73	0.04	0.44	0.01		
18	14.32	45.69	9.18	15.51	5.84	5.16	3.67	1.67	2.80	0.87	1.79	0.29	1.22	0.12	0.82	0.04	0.49	0.01		
20	15.91	55.54	10.20	18.86	6.49	6.27	4.08	2.03	3.11	1.05	1.99	0.35	1.36	0.14	0.91	0.05	0.55	0.02		
22	17.50	66.26	11.23	22.50	7.14	7.48	4.48	2.42	3.42	1.25	2.19	0.42	1.49	0.17	1.00	0.06	0.61	0.02		
24	19.10	77.84	12.25	26.43	7.79	8.79	4.89	2.84	3.74	1.47	2.39	0.50	1.63	0.20	1.10	0.08	0.66	0.02		
26			13.27	30.65	8.44	10.19	5.30	3.29	4.05	1.71	2.59	0.58	1.76	0.23	1.19	0.09	0.72	0.03		
28			14.29	35.16	9.09	11.69	5.71	3.78	4.36	1.96	2.79	0.66	1.90	0.26	1.28	0.10	0.77	0.03	0.35	0.00
30			15.31	39.95	9.74	13.29	6.12	4.29	4.67	2.23	2.99	0.75	2.04	0.30	1.37	0.11	0.83	0.03	0.38	0.01
35			17.86	53.15	11.36	17.68	7.14	5.71	5.45	2.96	3.48	1.00	2.38	0.39	1.60	0.15	0.97	0.04	0.44	0.01
40					12.98	22.64	8.16	7.31	6.23	3.80	3.98	1.28	2.72	0.51	1.83	0.19	1.11	0.06	0.51	0.01
45					14.61	28.15	9.18	9.10	7.01	4.72	4.48	1.59	3.06	0.63	2.06	0.24	1.24	0.07	0.57	0.01
50					16.23	34.22	10.20	11.06	7.79	5.74	4.98	1.94	3.40	0.76	2.29	0.29	1.38	0.09	0.64	0.01
55					17.85	40.83	11.22	13.19	8.57	6.85	5.48	2.31	3.74	0.91	2.52	0.35	1.52	0.10	0.70	0.02
60					19.48	47.97	12.24	15.50	9.35	8.04	5.98	2.71	4.08	1.07	2.75	0.41	1.66	0.12	0.76	0.02
65							13.26	17.97	10.13	9.33	6.48	3.15	4.42	1.24	2.98	0.48	1.80	0.14	0.83	0.02
70							14.28	20.62	10.90	10.70	6.97	3.61	4.76	1.42	3.21	0.55	1.94	0.16	0.89	0.02
75							15.30	23.43	11.68	12.16	7.47	4.10	5.10	1.62	3.44	0.62	2.08	0.18	0.96	0.03
80							16.32	26.40	12.46	13.71	7.97	4.62	5.44	1.82	3.67	0.70	2.22	0.21	1.02	0.03
85							17.34	29.54	13.24	15.33	8.47	5.17	5.78	2.04	3.89	0.78	2.35	0.23	1.08	0.04
90							18.36	32.84	14.02	17.05	8.97	5.75	6.12	2.27	4.12	0.87	2.49	0.26	1.15	0.04
95							19.38	36.30	14.80	18.84	9.47	6.35	6.46	2.51	4.35	0.96	2.63	0.28	1.21	0.04
100									15.58	20.72	9.96	6.99	6.80	2.76	4.58	1.06	2.77	0.31	1.28	0.05
110									17.14	24.72	10.96	8.34	7.48	3.29	5.04	1.26	3.05	0.37	1.40	0.06
120									18.70	29.04	11.96	9.79	8.16	3.87	5.50	1.48	3.33	0.44	1.53	0.07
130											12.96	11.36	8.84	4.48	5.96	1.72	3.60	0.51	1.66	0.08
140											13.95	13.03	9.52	5.14	6.42	1.97	3.88	0.58	1.79	0.09
150											14.95	14.81	10.20	5.84	6.88	2.24	4.16	0.66	1.92	0.10
160											15.95	16.69	10.88	6.59	7.34	2.53	4.44	0.74	2.04	0.11
170											16.94	18.67	11.56	7.37	7.79	2.83	4.71	0.83	2.17	0.13
180											17.94	20.75	12.24	8.19	8.25	3.14	4.99	0.93	2.30	0.14
190											18.94	22.94	12.92	9.05	8.71	3.47	5.27	1.02	2.43	0.16
200											19.93	25.23	13.60	9.95	9.17	3.82	5.55	1.12	2.56	0.17
225													15.30	12.38	10.32	4.75	6.24	1.40	2.88	0.21
250													17.00	15.05	11.47	5.77	6.93	1.70	3.20	0.26
275													18.70	17.95	12.61	6.89	7.63	2.03	3.52	0.31
300															13.76	8.09	8.32	2.38	3.84	0.36
325															14.91	9.39	9.02	2.76	4.16	0.42
350															16.05	10.77	9.71	3.17	4.48	0.48
375															17.20	12.23	10.40	3.60	4.80	0.55
400															18.35	13.79	11.10	4.06	5.12	0.62
425															19.49	15.42	11.79	4.54	5.44	0.69
450																	12.49	5.05	5.76	0.77
475																	13.18	5.58	6.08	0.85
500																	13.87	6.14	6.40	0.94
550																	15.26	7.32	7.04	1.12
600																	16.65	8.60	7.68	1.31

Note: Shaded areas of the chart indicate velocities over 5 feet per second (FPS). Use with caution.



Type K Copper Water Tube

SIZES: 1/2" - 3" **FLOW:** 1 - 600 GPM **PSI LOSS:** Per 100' of tube (PSI/100 FT) **C = 140**

SIZE	1/2"		5/8"		3/4"		1"		1 1/4"		1 1/2"		2"		2 1/2"		3"	
OD	0.625		0.750		0.875		1.125		1.375		1.625		2.125		2.625		3.125	
ID	0.527		0.652		0.745		0.995		1.245		1.481		1.959		2.435		2.907	
WALL THK.	0.049		0.049		0.065		0.065		0.065		0.072		0.083		0.095		0.109	
FLOW G. P. M.	Velocity FPS	psi Loss	Velocity FPS	psi Loss	Velocity FPS	psi Loss	Velocity FPS	psi Loss	Velocity FPS	psi Loss	Velocity FPS	psi Loss	Velocity FPS	psi Loss	Velocity FPS	psi Loss	Velocity FPS	psi Loss
1	1.45	1.09	0.95	0.39	0.73	0.20	0.41	0.05	0.26	0.02	0.18	0.01	0.10	0.00				
2	2.93	3.94	1.91	1.40	1.47	0.73	0.82	0.18	0.52	0.06	0.37	0.03	0.21	0.01				
3	4.40	8.35	2.87	2.974	2.20	1.55	1.23	0.38	0.78	0.13	0.55	0.05	0.31	0.01	0.20	0.00		
4	5.87	14.23	3.83	5.05	2.94	2.64	1.64	0.65	1.05	0.22	0.74	0.09	0.42	0.02	0.27	0.01	0.19	0.00
5	7.34	21.51	4.79	7.64	3.67	3.99	2.06	0.98	1.31	0.33	0.93	0.14	0.53	0.04	0.34	0.01	0.24	0.01
6	8.81	30.15	5.75	10.70	4.41	5.60	2.47	1.37	1.57	0.46	1.11	0.20	0.63	0.05	0.41	0.02	0.28	0.01
7	10.28	40.11	6.71	14.24	5.14	7.44	2.88	1.82	1.84	0.61	1.30	0.26	0.74	0.07	0.48	0.02	0.33	0.01
8	11.75	51.37	7.67	18.24	5.88	9.53	3.29	2.33	2.10	0.78	1.48	0.34	0.85	0.09	0.55	0.03	0.38	0.01
9	13.22	63.89	8.63	22.68	6.61	11.86	3.70	2.90	2.36	0.97	1.67	0.42	0.95	0.11	0.61	0.04	0.43	0.02
10	14.69	77.66	9.59	27.57	7.35	14.41	4.12	3.53	2.63	1.18	1.86	0.51	1.06	0.13	0.68	0.05	0.48	0.02
11	16.15	92.65	10.55	32.89	8.08	17.19	4.53	4.21	2.89	1.41	2.04	0.61	1.16	0.16	0.75	0.05	0.53	0.02
12	17.62	108.85	11.51	38.64	8.82	20.20	4.94	4.94	3.15	1.66	2.23	0.71	1.27	0.18	0.82	0.06	0.57	0.03
14			13.43	51.41	10.29	26.87	5.76	6.57	3.68	2.21	2.60	0.95	1.48	0.24	0.95	0.08	0.67	0.04
16			15.35	65.83	11.76	34.41	6.59	8.42	4.21	2.83	2.97	1.22	1.70	0.31	1.10	0.11	0.77	0.05
18			17.27	81.88	13.23	42.80	7.41	10.47	4.73	3.52	3.34	1.51	1.91	0.39	1.23	0.13	0.86	0.06
20			19.19	99.53	14.70	52.02	8.24	12.73	5.26	4.28	3.72	1.84	2.12	0.47	1.37	0.16	0.96	0.07
22					16.17	62.06	9.06	15.18	5.79	5.10	4.09	2.19	2.33	0.56	1.51	0.20	1.06	0.08
24					17.64	72.92	9.89	17.84	6.31	5.99	4.46	2.58	2.55	0.66	1.65	0.23	1.15	0.10
26					19.11	84.57	10.71	20.69	6.84	6.95	4.83	2.99	2.76	0.77	1.78	0.27	1.25	0.11
28							11.53	23.73	7.37	7.98	5.20	3.43	2.97	0.88	1.92	0.30	1.35	0.13
30							12.36	26.97	7.89	9.06	5.58	3.89	3.18	1.00	2.06	0.35	1.44	0.15
35							14.42	35.88	9.21	12.06	6.51	5.18	3.72	1.33	2.40	0.46	1.68	0.19
40							16.48	45.95	10.52	15.44	7.44	6.63	4.25	1.70	2.75	0.59	1.93	0.25
45							18.54	57.15	11.84	19.20	8.37	8.25	4.78	2.12	3.00	0.73	2.17	0.31
50									13.16	23.34	9.30	10.03	5.31	2.57	3.44	0.89	2.41	0.38
55									14.47	27.85	10.23	11.97	5.84	3.07	3.78	1.06	2.65	0.45
60									15.79	32.71	11.16	14.06	6.37	3.60	4.12	1.25	2.89	0.53
65									17.10	37.94	12.09	16.31	6.91	4.18	4.47	1.45	3.13	0.61
70									18.42	43.52	13.02	18.70	7.44	4.80	4.81	1.66	3.37	0.70
75									19.74	49.45	13.95	21.25	7.97	5.45	5.16	1.89	3.62	0.80
80											14.88	23.95	8.50	6.14	5.50	2.13	3.86	0.90
85											15.81	26.80	9.03	6.87	5.84	2.38	4.10	1.01
90											16.74	29.79	9.56	7.64	6.19	2.65	4.34	1.12
95											17.67	32.93	10.09	8.44	6.53	2.93	4.58	1.24
100											18.60	36.21	10.63	9.28	6.88	3.22	4.82	1.36
110													11.69	11.08	7.56	3.84	5.31	1.62
120													12.75	13.01	8.25	4.52	5.79	1.91
130													13.82	15.09	8.94	5.24	6.27	2.21
140													14.88	17.31	9.63	6.01	6.75	2.54
150													15.94	19.67	10.32	6.83	7.24	2.88
160													17.01	22.17	11.00	7.69	7.72	3.25
170													18.07	24.81	11.69	8.61	8.20	3.64
180													19.13	27.58	12.38	9.57	8.69	4.04
190															13.07	10.58	9.17	4.47
200															13.76	11.63	9.65	4.91
225															15.48	14.47	10.86	6.11
250															17.20	17.58	12.07	7.43
275															18.92	20.98	13.27	8.86
300																	14.48	10.41
325																	15.69	12.07
350																	16.89	13.85
375																	18.10	15.73
400																	19.31	17.73
425																		
450																		
475																		
500																		
550																		
600																		

Note: Shaded areas of the chart indicate velocities over 7 feet per second (FPS). Use with caution.

Charts

Polyethylene (PE) SDR-Pressure Rated Tube

SIZES: 1/2" – 6" **FLOW:** 1 – 600 GPM **PSI LOSS:** Per 100' of tube (PSI/100 FT) **C = 140** (2306, 3206, 3306) SDR 7, 9, 11.5, 15

SIZE	1/2"		3/4"		1"		1 1/4"		1 1/2"		2"		2 1/2"		3"		4"		6"	
ID	0.622		0.824		1.049		1.380		1.610		2.067		2.469		3.068		4.026		6.065	
FLOW G. P. M.	Velocity FPS	psi Loss	Velocity FPS	psi Loss	Velocity FPS	psi Loss	Velocity FPS	psi Loss	Velocity FPS	psi Loss	Velocity FPS	psi Loss	Velocity FPS	psi Loss	Velocity FPS	psi Loss	Velocity FPS	psi Loss	Velocity FPS	psi Loss
1	1.05	0.49	0.60	0.12	0.37	0.04	0.21	0.01	0.15	0.00	0.09	0.00								
2	2.10	1.76	1.20	0.45	0.74	0.14	0.42	0.04	0.31	0.02	0.19	0.01								
3	3.16	3.73	1.80	0.95	1.11	0.29	0.64	0.08	0.47	0.04	0.28	0.01	0.20	0.00						
4	4.21	6.35	2.40	1.62	1.48	0.50	0.85	0.13	0.62	0.06	0.38	0.02	0.26	0.01						
5	5.27	9.60	3.00	2.44	1.85	0.76	1.07	0.20	0.78	0.09	0.47	0.03	0.33	0.01	0.21	0.00				
6	6.32	13.46	3.60	3.43	2.22	1.06	1.28	0.28	0.94	0.13	0.57	0.04	0.40	0.02	0.26	0.01				
7	7.38	17.91	4.20	4.56	2.59	1.41	1.49	0.37	1.10	0.18	0.66	0.05	0.46	0.02	0.30	0.01				
8	8.43	22.93	4.80	5.84	2.96	1.80	1.71	0.474	1.25	0.22	0.76	0.07	0.53	0.03	0.34	0.03				
9	9.49	28.52	5.40	7.26	3.33	2.24	1.92	0.59	1.41	0.28	0.85	0.08	0.60	0.03	0.39	0.01				
10	10.54	34.67	6.00	8.82	3.70	2.73	2.14	0.72	1.57	0.34	0.95	0.10	0.66	0.04	0.43	0.01				
11	11.60	41.36	6.00	10.53	4.07	3.25	2.35	0.86	1.73	0.40	1.05	0.12	0.73	0.05	0.47	0.02	0.27	0.00		
12	12.65	48.60	7.21	12.37	4.44	3.82	2.57	1.01	1.88	0.48	1.14	0.14	0.80	0.06	0.52	0.02	0.30	0.01		
14	14.76	64.65	8.41	16.46	5.19	5.08	2.99	1.34	2.20	0.63	1.33	0.19	0.93	0.08	0.60	0.03	0.35	0.01		
16	16.87	82.79	9.61	21.07	5.93	6.51	3.42	1.71	2.51	0.81	1.52	0.24	1.07	0.10	0.69	0.04	0.40	0.01		
18	18.89	102.97	10.81	26.21	6.67	8.10	3.85	2.13	2.83	1.01	1.71	0.30	1.20	0.13	0.78	0.04	0.45	0.01		
20			12.01	31.86	7.41	9.84	4.28	2.59	3.14	1.22	1.90	0.36	1.33	0.15	0.86	0.05	0.50	0.01		
22			13.21	38.01	8.15	11.74	4.71	3.09	3.46	1.46	2.10	0.43	1.47	0.18	0.95	0.06	0.55	0.02		
24			14.42	44.65	8.89	13.79	5.14	3.63	3.77	1.72	2.29	0.51	1.60	0.21	1.04	0.07	0.60	0.02		
26			15.62	41.79	9.64	16.00	5.57	4.21	4.09	1.99	2.48	0.59	1.74	0.25	1.12	0.09	0.65	0.02		
28			16.82	59.41	10.38	18.35	5.99	4.83	4.40	2.28	2.67	0.68	1.87	0.29	1.21	0.10	0.70	0.03		
30			18.02	67.50	11.12	20.85	6.42	5.49	4.72	2.59	2.86	0.77	2.00	0.32	1.30	0.11	0.75	0.03	0.33	0.00
35					12.97	27.74	7.49	7.31	5.50	3.45	3.34	1.02	2.34	0.43	1.51	0.15	0.88	0.04	0.38	0.01
40					14.83	35.53	8.56	9.36	6.29	4.42	3.81	1.31	2.67	0.55	1.73	0.19	1.00	0.05	0.44	0.01
45					16.68	44.19	9.64	11.64	7.08	5.50	4.29	1.63	3.01	0.69	1.95	0.24	1.13	0.06	0.49	0.01
50					18.53	53.71	10.71	14.14	7.87	6.68	4.77	1.98	3.34	0.83	2.16	0.29	1.25	0.08	0.55	0.01
55							11.78	16.87	8.65	7.97	5.25	2.36	3.68	1.00	2.38	0.35	1.38	0.09	0.61	0.01
60							12.85	19.82	9.44	9.36	5.72	2.78	4.01	1.17	2.60	0.41	1.51	0.11	0.66	0.01
65							13.92	22.99	10.23	10.86	6.20	3.22	4.35	1.36	2.81	0.47	1.63	0.13	0.72	0.02
70							14.99	26.37	11.01	12.46	6.68	3.69	4.68	1.56	3.03	0.54	1.76	0.14	0.77	0.02
75							16.06	29.97	11.80	14.16	7.16	4.20	5.01	1.77	3.25	0.61	1.88	0.16	0.83	0.02
80							17.13	33.77	12.59	15.95	7.63	4.73	5.35	1.99	3.46	0.69	2.01	0.18	0.88	0.03
85							18.21	37.79	13.37	17.85	8.11	5.29	5.68	2.23	3.68	0.77	2.13	0.21	0.94	0.03
90							19.28	42.01	14.16	19.84	8.59	5.88	6.02	2.48	3.90	0.86	2.26	0.23	0.99	0.03
95							14.95	21.93	9.07	6.50	6.35	2.74	4.11	0.95	2.39	0.25	1.05	0.03		
100									15.74	24.12	9.54	7.15	6.69	3.01	4.33	1.05	2.51	0.28	1.10	0.04
110									17.31	28.77	10.50	8.53	7.36	3.59	4.76	1.25	2.76	0.33	1.22	0.05
120									18.88	33.80	11.45	10.02	8.03	4.22	5.20	1.47	3.02	0.39	1.33	0.05
130											12.41	11.62	8.70	4.90	5.63	1.70	3.27	0.45	1.44	0.06
140											13.36	13.33	9.37	5.62	6.06	1.95	3.52	0.52	1.55	0.07
150											14.32	15.15	10.03	6.38	6.50	2.22	3.77	0.59	1.66	0.08
160											15.27	17.08	10.70	7.19	6.93	2.50	4.02	0.67	1.77	0.09
170											16.23	19.11	11.37	8.05	7.36	2.80	4.27	0.75	1.88	0.10
180											17.18	21.24	12.04	8.95	7.08	3.11	4.53	0.83	1.99	0.11
190											18.14	23.48	12.71	9.89	8.23	3.44	4.78	0.92	2.10	0.12
200											19.09	25.81	13.38	10.87	8.66	3.78	5.03	1.01	2.21	0.14
225													15.05	13.52	9.75	4.70	5.66	1.25	2.49	0.17
250													16.73	16.44	10.83	5.71	6.29	1.52	2.77	0.21
275													18.40	19.61	11.92	6.82	6.92	1.82	3.05	0.25
300															13.00	8.01	7.55	2.13	3.32	0.29
325															14.08	9.29	8.18	2.48	3.60	0.34
350															15.17	10.65	8.81	2.84	3.88	0.39
375															16.25	12.10	9.43	3.23	4.15	0.44
400															17.33	13.64	10.06	3.64	4.43	0.50
425															18.42	15.26	10.69	4.07	4.71	0.55
450															19.50	16.97	11.32	4.52	4.99	0.62
475																	11.95	5.00	5.26	0.68
500																	12.58	5.50	5.54	0.75
550																	13.84	6.56	6.10	0.89
600																	15.10	7.70	6.65	1.05

Note: Shaded areas of the chart indicate velocities over 5 feet per second (FPS). Use with caution.

Schedule 40 Standard Steel Pipe

SIZES: 1/2" - 6" **FLOW:** 1 - 600 GPM **PSI LOSS:** Per 100' of pipe (PSI/100 FT) **C = 100 15**

SIZE	1/2"		3/4"		1"		1 1/4"		1 1/2"		2"		2 1/2"		3"		4"		6"	
OD	0.840		1.050		1.315		1.660		1.900		2.375		2.875		3.500		4.500		6.625	
ID	0.622		0.824		1.049		1.380		1.610		2.067		2.469		3.068		4.026		6.065	
WALL THK.	0.109		0.113		0.133		0.140		0.145		0.154		0.203		0.216		0.237		0.280	
FLOW G. P. M.	Velocity FPS	psi Loss	Velocity FPS	psi Loss	Velocity FPS	psi Loss	Velocity FPS	psi Loss	Velocity FPS	psi Loss	Velocity FPS	psi Loss	Velocity FPS	psi Loss	Velocity FPS	psi Loss	Velocity FPS	psi Loss	Velocity FPS	psi Loss
1	1.05	0.91	0.60	0.23	0.37	0.07	0.21	0.02	0.15	0.01	0.09	0.00								
2	2.10	3.28	1.20	0.84	0.74	0.26	0.42	0.07	0.31	0.03	0.19	0.01	0.13	0.00						
3	3.16	6.95	1.80	1.77	1.11	0.55	0.64	0.14	0.47	0.07	0.28	0.02	0.20	0.01	0.13	0.00				
4	4.21	11.85	2.40	3.02	1.48	0.93	0.85	0.25	0.62	0.12	0.38	0.03	0.26	0.01	0.17	0.01				
5	5.27	17.91	3.00	4.56	1.85	1.41	1.07	0.37	0.78	0.18	0.47	0.05	0.33	0.02	0.21	0.01				
6	6.32	25.10	3.60	6.39	2.22	1.97	1.28	0.52	0.94	0.25	0.57	0.07	0.40	0.03	0.26	0.01				
7	7.38	33.40	4.20	8.50	2.59	2.63	1.49	0.69	1.10	0.33	0.66	0.10	0.46	0.04	0.30	0.01				
8	8.43	42.77	4.80	10.89	2.96	3.36	1.71	0.89	1.25	0.42	0.76	0.12	0.53	0.05	0.34	0.02	0.20	0.00		
9	9.49	53.19	5.40	13.54	3.33	4.18	1.92	1.10	1.41	0.52	0.85	0.15	0.60	0.06	0.39	0.02	0.22	0.01		
10	10.54	64.65	6.00	16.46	3.70	5.08	2.14	1.34	1.57	0.63	0.95	0.19	0.66	0.08	0.43	0.03	0.25	0.01		
11	11.60	77.13	6.60	19.63	4.07	6.07	2.35	1.60	1.73	0.75	1.05	0.22	0.73	0.09	0.47	0.03	0.27	0.01		
12	12.65	90.62	7.21	23.07	4.44	7.13	2.57	1.88	1.88	0.89	1.14	0.26	0.80	0.11	0.52	0.04	0.30	0.01		
14	14.76	20.56	8.41	30.69	5.19	9.48	2.99	2.50	2.20	1.18	1.33	0.35	0.93	0.15	0.60	0.05	0.35	0.01		
16	16.87	54.39	9.61	39.30	5.93	12.14	3.42	3.20	2.51	1.51	1.52	0.45	1.07	0.19	0.69	0.07	0.40	0.02		
18	18.89	92.02	10.81	48.88	6.67	15.10	3.85	3.98	2.83	1.88	1.71	0.56	1.20	0.23	0.78	0.08	0.45	0.02		
20			12.01	59.41	7.41	18.35	4.28	4.83	3.14	2.28	1.90	0.68	1.33	0.29	0.86	0.10	0.50	0.03		
22			13.21	70.88	8.15	21.90	4.71	5.77	3.46	2.72	2.10	0.81	1.47	0.34	0.95	0.12	0.55	0.03	0.24	0.00
24			14.42	83.27	8.89	25.72	5.14	6.77	3.77	3.20	2.29	0.95	1.60	0.40	1.04	0.14	0.60	0.04	0.26	0.01
26			15.62	96.57	9.64	29.83	5.57	7.86	4.09	3.71	2.48	1.10	1.74	0.46	1.12	0.16	0.65	0.04	0.28	0.01
28			16.82	110.8	10.38	34.22	5.99	9.01	4.40	4.26	2.67	1.26	1.87	0.53	1.21	0.18	0.70	0.05	0.31	0.01
30			18.02	125.9	11.12	38.89	6.42	10.24	4.72	4.84	2.86	1.43	2.00	0.60	1.30	0.21	0.75	0.06	0.33	0.01
35					12.97	51.74	7.49	13.62	5.50	6.44	3.34	1.91	2.34	0.80	1.51	0.28	0.88	0.07	0.38	0.01
40					14.83	66.25	8.56	17.45	6.29	8.24	3.81	2.44	2.67	1.03	1.73	0.36	1.00	0.10	0.44	0.01
45					16.68	82.40	9.64	21.70	7.08	10.25	4.29	3.04	3.01	1.28	1.95	0.44	1.13	0.12	0.49	0.02
50					18.53	100.2	10.71	26.37	7.87	12.46	4.77	3.69	3.34	1.56	2.16	0.54	1.25	0.14	0.55	0.02
55							11.78	31.47	8.65	14.86	5.25	4.41	3.68	1.86	2.38	0.65	1.38	0.17	0.61	0.02
60							12.85	36.97	9.44	17.46	5.72	5.18	4.01	2.18	2.60	0.76	1.51	0.20	0.66	0.03
65							13.92	42.88	10.23	20.25	6.20	6.00	4.35	2.53	2.81	0.88	1.63	0.23	0.72	0.03
70							14.99	49.18	11.01	23.23	6.68	6.89	4.68	2.90	3.03	1.01	1.76	0.27	0.77	0.04
75							16.06	55.89	11.80	26.40	7.16	7.83	5.01	3.30	3.25	1.15	1.88	0.31	0.83	0.04
80							17.13	62.98	12.59	29.75	7.63	8.82	5.35	3.72	3.46	1.29	2.01	0.34	0.88	0.05
85							18.21	70.47	13.37	33.29	8.11	9.87	5.68	4.16	3.68	1.44	2.13	0.39	0.94	0.05
90							19.28	78.33	14.16	37.00	8.59	10.97	6.02	4.62	3.90	1.61	2.26	0.43	0.99	0.06
95							14.95	40.90	9.07	12.13	6.35	5.11	4.11	1.78	2.39	0.47	1.05	0.06		
100									15.74	44.97	9.54	13.33	6.69	5.62	4.33	1.95	2.51	0.52	1.10	0.07
110									17.31	53.66	10.50	15.91	7.36	6.7	4.76	2.33	2.76	0.62	1.22	0.08
120									18.88	63.04	11.45	18.69	8.03	7.87	5.20	2.74	3.02	0.73	1.33	0.10
130											12.41	21.68	8.70	9.13	5.63	3.17	3.27	0.85	1.44	0.12
140											13.36	24.87	9.37	10.47	6.06	3.64	3.52	0.97	1.55	0.13
150											14.32	28.26	10.03	11.90	6.50	4.14	3.77	1.10	1.66	0.15
160											15.27	31.84	10.70	13.41	6.93	4.66	4.02	1.24	1.77	0.17
170											16.23	35.63	11.37	15.01	7.36	5.22	4.27	1.39	1.88	0.19
180											17.18	39.61	12.04	16.68	7.80	5.80	4.53	1.55	1.99	0.21
190											18.14	43.78	12.71	18.44	8.23	6.41	4.78	1.71	2.10	0.23
200											19.09	48.14	13.38	20.28	8.66	7.05	5.03	1.88	2.21	0.26
225													15.08	25.22	9.75	8.76	5.66	2.34	2.49	0.32
250													16.73	30.65	10.83	10.65	6.29	2.84	2.77	0.39
275													18.40	36.57	11.92	12.71	6.92	3.39	3.05	0.46
300															13.00	14.93	7.55	3.98	3.32	0.54
325															14.08	17.32	8.18	4.62	3.60	0.63
350															15.17	19.87	8.81	5.30	3.88	0.72
375															16.25	22.57	9.43	6.02	4.15	0.82
400															17.33	25.44	10.06	6.78	4.43	0.92
425															18.42	28.46	10.69	7.59	4.71	1.03
450															19.50	31.64	11.32	8.43	4.99	1.15
475																	11.95	9.32	5.26	1.27
500																	12.58	10.25	5.54	1.40
550																	13.84	12.23	6.10	1.67
600																	15.10	14.37	6.65	1.96

Note: Shaded areas of the chart indicate velocities over 7 feet per second (FPS). Use with caution.

Warranty

Limited Product Warranty

All K-Rain® professional gear drive rotors, sprays and valves carry a five year "Limited Warranty" from the date of purchase unless otherwise stated. All K-Rain® electronic products carry a two year "Limited Warranty" from the date of purchase unless otherwise stated. During this period K-Rain® will repair or replace (at the option of K-Rain®) the product or any part if the product is found to be defective as to workmanship or material.

This warranty does not extend to damage to a K-Rain® product resulting from misuse, neglect or abuse, normal wear and tear, or accident, to exterior appearance or color or due to improper installation. Various products may carry a longer warranty time period; check individual product specification sheets for warranty period.

This warranty extends only to an original user of a K-Rain® product.

IN NO EVENT SHALL K-RAIN® BE LIABLE FOR INCIDENTAL OR CONSEQUENTIAL DAMAGES. ALL IMPLIED WARRANTIES ARE LIMITED IN DURATION TO TWO YEARS FOLLOWING DATE OF PURCHASE UNLESS INDICATED OTHERWISE.

Some U.S. states do not permit the exclusion or limitation of incidental or consequential damages or of implied warranties. Therefore, the above exclusions or limitations may not apply to you. If a defect arises in a K-Rain® product within the warranty period, you should promptly contact your K-Rain® installer, distributor or K-RAIN® MANUFACTURING CORPORATION.

This warranty gives you specific legal rights, and you may also have other rights which vary from state to state. If you have any questions concerning the warranty or its application, please contact K-Rain®:

K-Rain® Manufacturing Corp.

1640 Australian Avenue

Riviera Beach, FL 33404 USA

561.844.1002

FAX: 561.842.9493

1.800.735.7246 | www.krain.com

K-RAIN | Designed for easy. Built for reliable.



K-Rain® Manufacturing Corp.
1640 Australian Avenue
Riviera Beach, FL 33404 USA
561.844.1002
Fax: 561.842.9493
1.800.735.7246

© K-Rain Manufacturing Corporation
AN ISO 9001 CERTIFIED COMPANY

www.krain.com

Follow us on social media:

