















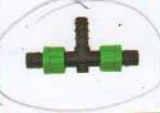

拉扣式带用配件 Lock Ring Fitting for Drip Tape

产品名称 Product Description	图片 Picture	货号 Item No.	规格 Size	每袋数量 Qty/Bag (Pc)	每箱数量 Qty/Ctn (Pc)	纸箱规格 Ctn Size (Cm)	毛重 G.W (Kg)
拉扣带用旁通接头 Lock Ring Offtake for Drip Tape		TO011312	Dn13*12	100	3500	54*35*28	14
		TO021712	Dn17*12	100	2000	54*35*28	12
PVC 管用拉扣旁通 (带单层胶圈) PVC Offtake for Drip Tape		TO011312R	Dn13	100	3300	54*35*28	15
		TO021712R	Dn17	100	1800	54*35*28	14
拉扣带用直接 Lock Ring Coupling for Drip Tape		LC0213	Dn13	100	3000	54*35*28	16
		LC0217	Dn17	100	1400	54*35*28	12
拉扣带用承插接头 Barb Lock Ring Coupling for Drip Tape		BC021617	Dn17*16	100	1600	54*35*28	11
外螺纹拉扣带用接头 Male Thread Lock Ring Coupling for Drip Tape		MT021712	Dn17*16	100	1600	54*35*28	12
带用拉扣弯头 Lock Ring Elbow for Drip Tape		ET0217	Dn17	100	1200	54*35*28	12
拉扣带用三通 Lock Ring Tee for Drip Tape		TT0317	Dn17	50	700	54*35*28	14
拉扣带用旁通三通 Offtake Lock Ring Tee for Drip Tape		BT041712	Dn17*12*17	50	800	54*35*28	14
PVC 管用拉扣带用 旁通三通 PVC Offtake Lock Ring Tee for Drip Tape		BT041712R	Dn17*12*17	50	700	54*35*28	14
拉扣带用接头 Lock Ring Tape Plug		TP0317	Dn17	100	2000	54*35*28	11

锁扣式带用配件 Lock Nut Fitting for Drip Tape

产品名称 Product Description	图片 Picture	货号 Item No.	规格 Size	每袋数量 Qty/Bag (Pc)	每箱数量 Qty/Ctn (Pc)	纸箱规格 Ctn Size (Cm)	毛重 G.W (Kg)
带用旁通接头 Tape Offtake		TO011706	Dn17*6	100	1500	54*35*28	17
		TO011712	Dn17*12	100	1300	54*35*28	15
带用锁扣旁通 Lock Type Offtake		LO0117	Dn17	100	1000	54*35*28	13
带用旁通 (带单层胶圈) PVC Offtake for Tape		PO0117R	Dn17	100	1100	54*35*28	15
带用锁扣直接 Lock Coupling for Tape		LC0117	Dn17	100	800	54*35*28	14
		LC0122	Dn22	100	500	54*35*28	17
带用承插接头 Barbed Coupling for Tape		BC011617	Dn17*16	100	1100	54*35*28	14
		BC012022	Dn22*20	100	600	54*35*28	12
外螺纹带用接头 Male Thread Coupling for Tape		MT011712	Dn17*1/2"	100	1000	54*35*28	14
		MT011734	Dn17*3/4"	100	1000	54*35*28	15
带用涂塑软管旁通 接头 Connection for Lay Flat Hose		CT0117	Dn17	100	900	54*35*28	17
可折式带用涂塑软管 旁通接头 Connection for Lay Flat Hose		CT0217	Dn17	100	550	54*35*28	16
涂塑软管快速带用 接头 Croco Offtake for Lay Flat Hose		CT0317	Dn17	100	700	54*35*28	19

产品名称 Product Description	图片 Picture	货号 Item No.	规格 Size	每袋数量 Qty/Bag (Pc)	每箱数量 Qty/Ctn (Pc)	纸箱规格 Ctn Size (Cm)	毛重 G.W (Kg)
带用锁扣弯头 Lock Elbow for Tape		ET0117	Dn17	100	700	54*35*28	14
单边承插式带用三通 One Barb Tape Tee		BT011716	Dn17*16*17	50	500	54*35*28	12
单头锁扣三通 Tape Tee with Two Barb		BT021716	Dn17*16	50	800	54*35*28	12
PVC 管用旁通带用三通 Offtake Tee for Tape with Rubber Ring		BT031708R	Dn17*10	50	400	54*35*28	12
三边锁扣带用三通 Lock Tee for Tape		TT0117	Dn17	50	300	54*35*28	10
外螺纹带用三通 Male Threaded Tape Tee		TT021712	Dn17*1/2"	50	450	54*35*28	12
可折式带用涂塑软管三通接头 Tape Tee for Lay Flat Hose		TT0417	Dn17	50	300	54*35*28	13
锁扣式带用堵头 Tape Plug		TP0117	Dn17	100	2000	54*35*28	18
折叠式带用堵头 Tape Sleeve End		TP0217	Dn17	100	2400	54*35*28	20



滴灌带用阀门 Mini Valve for Drip Tape

产品名称 Product Description	图片 Picture	货号 Item No.	规格 Size	每袋数量 Qty/Bag (Pc)	每箱数量 Qty/Ctn (Pc)	纸箱规格 Ctn Size (Cm)	毛重 G.W (Kg)
多功能 带用管用阀门 Multi Valve for Drip Tape and Pipe		MV021617	Dn16*17	50	450	54*35*28	17
多功能带用管用阀门 (带双层胶圈) Multi Valve for Drip Tape and Pipe (With H Grommet)		MV021617R	Dn16*17	50	400	54*35*28	17
承插带用阀门 Barb-Lock Vale for Tape		BV011617	Dn16*17	50	450	54*35*28	16
带用锁扣旁通阀门 Offtake Valve for Tape		OV0217	Dn17	50	450	54*35*28	16
带用旁通阀门 Offtake Tape Valve		OV031708	Dn17*8	50	450	54*35*28	16
带用旁通阀门 (带单层胶圈) Offtake Tape Valve with T Grommet		OV031708R	Dn17*8	50	400	54*35*28	17
外螺纹带用阀门 Male Thread Valve for Tape		TV0117	Dn17*1/2"	50	400	54*35*28	16
双边带用锁扣阀门 Lock Tape Coupler with Valve		LV0117	Dn17	50	450	54*35*28	17
涂塑软管 旁通带用阀门 Tape Valve for Lay Flat Hose		TV0217	Dn17	50	300	54*35*28	16

滴箭及其配件 Arrow Dripper and Accessory

滴箭

- 滴箭与 Dn5/3 PVC 软管相连接, 可同时有多个滴箭并连, 一般有一出一、一出二和一出四, 三种规格。
- 特别适用于盆栽作物的灌溉或定向作物灌溉。

Arrow Dipper

- Arrow Dripper is connected with Dn5/3mm soft PVC pipe and adapter, also can be connected with Multi-outlet assemblies to get several outlet in same time.
- Fit for watering the plants in pots.

产品名称 Product Description	图片 Picture	货号 Item No.	规格 Size	每袋数量 Qty/Bag (Pc)	每箱数量 Qty/Ctn (Pc)	纸箱规格 Ctn Size (Cm)	毛重 G.W (Kg)
直滴箭 Straight Arrow Dripper		2101	1.8L/h	100	5000	54*35*28	13
弯滴箭 Bend Arrow Dripper		2102	2.2L/h	100	4500	54*35*28	10
长弯滴箭 Long Bend Arrow		2152	2.2L/h	100	2800	54*35*28	10
一出直滴箭 One Branch Straight Arrow Dripper		2111	50cm*1	10	1800	66*31*40	18
一出弯滴箭 One Branch Bend Arrow Dripper		2112	50cm*1	10	1500	66*31*40	16
二出直滴箭 Two Branches Straight Arrow Dripper		2121	50cm*2	10	750	66*31*40	18
二出弯滴箭 Two Branches Bend Arrow Dripper		2122	50cm*2	10	700	66*31*40	17
四出直滴箭 Four Branches Straight Arrow Dripper		2141A	50cm*4 Dn3	10	350	66*31*40	17
		2141B	50cm*4 Dn4	10	350	66*31*40	17
四出弯滴箭 Four Branches Bend Arrow Dripper		2142A	50cm*4 Dn3	10	300	66*31*40	13
		2142B	50cm*4 Dn4	10	300	66*31*40	13
一出长弯滴箭 One Branches Long Arrow Dripper		21521	50cm*1	10	1100	66*31*40	13
二出长弯滴箭 Two Branches Long Arrow Dripper		21522	50cm*2	10	400	66*31*40	10
四出长弯滴箭 Four Branches Long Arrow Dripper		21524A	50cm*4 Dn3	10	200	66*31*40	10
		21524B	50cm*4 Dn4	10	200	66*31*40	10

滴箭配件 Accessory for Arrow Dripper

产品名称 Product Description	图片 Picture	货号 Item No.	规格 Size	每袋数量 Qty/Bag (Pc)	每箱数量 Qty/Ctn (Pc)	纸箱规格 Ctn Size (Cm)	毛重 G.W (Kg)
PVC 软管 PVC Soft Pipe		PV010453	Dn5/3	500m/roll	3rolls/bag	Dn45*60	30
单倒刺接头 Adaptor for Micro Tube		5131	Dn5	500	25000	42*28*21	9
双倒刺接头 Two Branches for Micro Tube		5132	Dn5	500	25000	42*28*21	9
双倒刺三通 Two Branches for Micro Tube		5133	Dn5	500	13000	42*28*21	9
四倒刺五通 Five Branches for Micro Tube		5135A	Dn5*5	500	6000	42*28*21	7
四倒刺五通 Five Branches for Micro Tube		5135B	Dn6*5	500	6000	42*28*21	7

技术参数 Technical Data:

货号 Item No.	工作压力 VS 流量 Working Preaature (Bar) VS Discharge(L/h) CV ≤ 5%										流态指数 Flow Index
	0.2Bar	0.4Bar	0.6Bar	0.8Bar	1.0Bar	1.2Bar	1.4Bar	1.6Bar	1.8Bar	2.0Bar	
2101	0.6	1.1	1.4	1.6	1.8	2.0	2.3	2.4	2.5	2.6	$Q=1.8H^{0.619}$
2102	0.9	1.5	1.7	2.0	2.2	2.4	2.7	2.9	3.2	3.4	$Q=2.2H^{0.548}$
2152	0.9	1.4	1.7	2.0	2.2	2.4	2.6	2.7	2.9	3.1	$Q=2.2H^{0.516}$



管上式滴头 On-Line Dripper

特点:

- 采用优质工程塑料生产,耐化学腐蚀、抗紫外线、抗老化。
- 独特宽流道或紊流道设计,抗堵塞能力强。
- 其中可拆洗滴头方便拆装易于清洗。
- 流量可调式滴头,调整流量范围广,可适用地形起伏不定的灌溉区域,通过调整不同落差位置每个滴头的流量,达到整个灌溉区域每个滴头出水量均匀的效果。
- 紊流式管上滴头,具有一定的压力补偿效果,同时工作压力范围广,可适用地形起伏较大的灌溉区域,当地形落差较大,超过常规压力补偿滴头的工作压力范围时,可代替其使用。
- 采购成本和安装维护费用相对较低,便于广泛使用。
- 在低压力情况下,流量稳定性好,推荐使用压力范围为 1-1.5bar。
- 可以与 Dn6mm 软管联接或打孔直接安装在 Dn12-32PE 软管上,易于安装维护。
- 可广泛用于落木丛、果园和其他作物的灌溉。

Advantage:

- Stable and high quality material resistant to agricultural chemicals and UV degradation.
- Highly clog-resistant due to wide, deep turbulent passageways.
- Easy to remove for inspection and cleaning.
- Low cost of these dripper makes them very popular.
- The discharges are rated from 1 bar to 1.5bar, and at lower pressure you will get a lower discharge and at higher pressure you will get a somewhat higher discharge.
- At very low pressure, these drippers work better than pressure compensating dripper.
- Easy installation, connect them with Dn6mm hose or insert them onto Dn12-32 PE hose directly for various requirement of irrigation.

Application:

- Ideal for those installations where quality of the water may represent a problem, you can be easy to clean the emitter if you use Take apart dripper
- Ideal for those installations where the terrain of land is excessive to be sure them work well although the differential head is large.
- Suitable for most horticultural trees, row crops, and vineyards.

产品名称 Product Description	图片 Picture	货号 Item No.	规格 Size	每袋数量 Qty/Bag (Pc)	每箱数量 Qty/Ctn (Pc)	纸箱规格 Ctn Size (Cm)	毛重 G.W (Kg)
可拆洗式滴头 Take Apart Dripper		TAD0104	4L/h	100	11000	54*35*28	18
		TAD0108	8L/h	100	11000	54*35*28	18
		TAD0116	16L/h	100	11000	54*35*28	18
可调式管上式滴头 Adjustable On-line		AOD0170	1/4" 0-70L/h@1Bar 15cm Length	100	8800	54*35*28	15
可调式地插滴头 Adjustable Sprayer		AOD0170H	1/4" 0-70L/h@1Bar 15cm Length	100	1500	54*35*28	8
紊流式管上滴头 Turbulent Flowing On-line Dripper		TOD0102	2L/h	100	3600	54*35*28	16
		TOD0104	4L/h	100	3600	54*35*28	16
		TOD0108	8L/h	100	3600	54*35*28	16
		TOD0116	16L/h	100	3600	54*35*28	16

技术参数 Technical Data:

货号 Item No.	工作压力 VS 流量 Working Preaature (Bar) VS Discharge(L/h)						
	0.7Bar	1.0Bar	1.5Bar	2.0Bar	2.5Bar	3.0Bar	3.5Bar
TAD0104	3.4	3.8	4.2	4.5	4.7	5.1	5.5
TAD0108	7.1	8.1	8.5	9.1	9.4	10.2	11.3
TAD0116	14.7	16.3	17.1	17.9	18.6	19.7	21.6
TOD0102	1.5	2.0	2.6	3.1	3.6	4.1	4.4
TOD0104	3.5	4.1	5.0	5.8	6.5	7.2	7.8
TOD0108	6.7	7.9	9.7	11.5	13.0	14.4	15.8
TOD0116	14.2	16.1	20.9	25.1	29.2	32.8	36.2

* 备注: 以上滴头使用 6mm 毛管连接, 用 3mm 打孔器。

* Note: All above dripper with 6mm Barb Adaptor, for installation use Dn3mm Punch

AOD0170 标准						
齿数 Click	工作压力 VS 流量 Working Preaature (Bar) VS Discharge(L/h)					
	0.5Bar	1.0Bar	1.5Bar	2.0Bar	2.5Bar	3.0Bar
2	12.0	17.6	27.3	30.6	35.1	39.0
4	16.1	25.3	31.5	38.0	43.7	48.8
8	23.0	36.3	44.4	52.5	59.7	68.2
12	29.6	46.2	55.2	65.0	72.3	79.9
16	33.1	48.1	61.9	73.0	81.5	89.0
20	35.7	55.3	70.5	81.3	94.2	102.2
24	41.0	65.1	80.3	92.6	106.1	115.6
30	51.2	76.2	98.7	114.0	127.1	140.8
32	52.7	80.0	98.7	115.1	130.5	143.0

* 备注: 16 齿 = 1 圈 32 齿 = 2 圈, 最大可调为 2 圈

最小射程半径: 5cm@1Bar 最大射程半径: 40cm@1Bar

流量小于 12L/H 时滴水, 大于 12L/H 伞状出水

* Note: 16click=1Turn 32click=2Turn Max Adjusting 2Turn

Minimum Spray Radius 5cm@1bar, Maximum Spray Radius 40cm@1bar

Drip out when the flowing is less than 12L/h, Spary out when the flowing is more than 12L/h



压力补偿滴头 Dripper with PC

特点:

- 在因距离差或地面不平整而产生不同压力情况下, 压力补偿滴头可提供稳定的滴水量。
- 可拆式压力补偿滴头可以方便打开外壳, 易于清洗。
- 自清洗式压力补偿滴头采用宽流道设计, 抗堵塞能力强。
- 防倒吸式压力补偿滴头采用紊流道设计, 当压力低于 0.15bar 时自动关闭出水口, 当压力达到 0.4bar 滴头才出水, 防止系统开关过程中产生倒吸堵塞出水口, 同时也避免在系统关闭后出现滴漏水现象。
- 可以与 Dn6mm 软管联接或打孔直接安装在 Dn12-32PE 软管上, 易于安装维护, 可降低施工和维护成本

Advantage:

- PC dripper deliver a precise amount of water regardless of changes in pressure due to long rows or change in terrain.
- Take Apart PC dripper with removable cap for easy cleaning.
- Compact PC dripper with wide and deep passageways for highly clog-resistant .
- Compact PC dripper with wide and deep passageways for highly clog-resistant .
- No-drain PC dripper with turbulent passageways, can be self-flushing with opening pressure at 0.4bar and shutting off pressure at 0.15bar which prevents drainage from system and also allow system start and shut off quickly without leakage .
- Simplify the design of a system and greatly reduce the cost of installation and maintenance.
- Easy installation, connect them with Dn6mm hose or insert them onto Dn12-32 PE hose directly for various requirement of irrigation.

产品名称 Product Description	图片 Picture	货号 Item No.	规格 Size	每袋数量 Qty/Bag (Pc)	每箱数量 Qty/Ctn (Pc)	纸箱规格 Ctn Size (Cm)	毛重 G.W (Kg)
可拆式压力补偿滴头 Take Apart PC Dripper		PCT0102	2L/h	100	4500	54*35*28	17
		PCT0104	4L/h	100	4500	54*35*28	17
		PCT0108	8L/h	100	4500	54*35*28	17
管上式自清洗压力补偿滴头 Compact On-line PC Dripper		PCT0304	4L/h	100	16000	54*35*28	17
		PCT0308	8L/h	100	16000	54*35*28	17
		PCT0312	12L/h	100	16000	54*35*28	17
防倒吸式压力补偿滴头 No-Drain PC Dripper		DPE0102	2L/h	100	7000	54*35*28	20
		DPE0104	4L/h	100	7000	54*35*28	20
		DPE0108	8L/h	100	7000	54*35*28	20

技术参数 Technical Data:

货号 Item No.	工作压力 VS 流量 Working Preaature (Bar) VS Discharge(L/h)								
	0.5Bar	0.7Bar	1.0Bar	1.5Bar	2.0Bar	2.5Bar	3.0Bar	3.5Bar	4.0Bar
PCT0102	1.9	2.0	2.1	2.0	2.2	2.1	2.2	2.2	2.1
PCT0104	3.7	3.9	4.1	4.2	4.2	4.3	4.4	4.2	4.1
PCT0108	7.8	7.9	8.0	8.2	8.1	8.4	8.3	8.1	7.9
PCT0304	3.8	3.9	4.0	4.1	4.1	4.1	4.0	3.9	4
PCT0308	7.9	7.9	8.1	8.2	8.1	8.0	8.0	7.9	7.8
PCT0312	11.5	11.5	11.7	11.9	12.1	12.2	12.0	11.8	11.7
DPE0102	1.8	1.8	2.1	2.2	2.3	2.4	2.1	1.7	1.7
DPE0104	3.6	3.6	4.1	4.2	4.4	4.2	3.8	3.4	3.4
DPE0108	7.6	7.6	7.9	8.5	8.8	8.7	7.8	7.5	7.5

* Note: All above dripper with 1/4" Barb Adaptor, for installation use Dn3mm Punch

旋转微喷头和折射喷头 Microsprinkler & Microjet

产品名称 Product Description	图片 Picture	货号 Item No.	规格 Size	每袋数量 Qty/Bag (Pc)	每箱数量 Qty/Ctn (Pc)	纸箱规格 Ctn Size (Cm)	毛重 G.W (Kg)
倒挂式旋转微喷头 Microsprinkler, Upside Down Type		MS1101A - MS1104A	Dn7	100	3000	54*35*28	15
地插式旋转微喷头 Microsprinkler, Standing Type		MS1101B - MS1104B	Dn7	100	3000	54*35*28	15
防虫式旋转微喷头 Anti-Insect Microsprinkler		MS3002 - MS3008	Dn7	100	4600	54*35*28	20

技术参数 Technical Data:

工作压力 Working Pressure		1.5Bar		2.0Bar		2.5Bar		3.0Bar	
货号 Item No.	喷嘴颜色 Nozzle Color	流量 Discharge	直径 Diameter	流量 Discharge	直径 Diameter	流量 Discharge	直径 Diameter	流量 Discharge	直径 Diameter
MS1101A	Black	24.6L/h	6.4m	28L/h	7.0m	31L/h	7.0m	34L/h	7.2m
MS1102A	Blue	39L/h	7.8m	44L/h	8.0m	49L/h	8.2m	54L/h	8.4m
MS1103A	Green	58.5L/h	8.0m	66.6L/h	8.6m	75L/h	8.8m	82.5L/h	8.8m
MS1104A	Red	73.5L/h	2.8m	82.8L/h	8.6m	93.9L/h	8.8m	103.5L/h	9.0m
MS1101B	Black	24.6L/h	5.0m	28L/h	5.6m	31L/h	6.0m	34L/h	6.4m
MS1102B	Blue	39L/h	6.4m	44L/h	6.4m	49L/h	7.0m	54L/h	7.2m
MS1103B	Green	58.5L/h	6.8m	66.8L/h	7.0m	75L/h	7.4m	82.5L/h	7.8m
MS1104B	Red	73.5L/h	7.4m	82.8L/h	8.0m	93.9L/h	8.0m	103.5L/h	8.4m
MS3002	Gray	42.20L/h	4.2m	47.50L/h	4.6m	51.70L/h	5.0m	58.40L/h	5.6m
MS3003	Black	59.00L/h	4.6m	68.60L/h	5.0m	76.20L/h	5.4m	83.20L/h	6.0m
MS3004	Green	79.30L/h	5.2m	97.00L/h	5.6m	100.60L/h	6.0m	106.20L/h	6.4m
MS3005	Blue	96.20L/h	5.6m	109.40L/h	6.2m	123.00L/h	6.4m	126.40L/h	6.6m
MS3006	Red	128.00L/h	6.2m	144.80L/h	3.3m	155.80L/h	7.0m	179.00L/h	7.2m
MS3007	Yellow	149.00L/h	6.4m	168.00L/h	7.0m	189.60L/h	7.2m	213.60L/h	7.4m
MS3008	Light Green	193.00L/h	7.0m	218.00L/h	7.4m	245.00L/h	7.4m	277.60L/h	7.6m

旋转微喷头和折射喷头 Microsprinkler & Microjet

产品名称 Product Description	图片 Picture	货号 Item No.	规格 Size	每袋数量 Qty/Bag (Pc)	每箱数量 Qty/Ctn (Pc)	纸箱规格 Ctn Size (Cm)	毛重 G.W (Kg)
倒挂式 360 度全圆微喷头 360° No Bridge Mini Sprinklers, Upside Down Type		MS8050 - MS80120	Dn7	100	4500	54*35*28	19
地插式 360 度全圆微喷头 360° No Bridge Mini Sprinklers, Standing Type		MS8150 - MS81120	Dn7	100	4500	54*35*28	19

技术参数 Technical Data:

压力 V S 流量和射程 Pressure VS Flowing A Wetting Radius												
工作压力 Working Pressure		1Bar		1.5Bar		2.0Bar		2.5Bar		3.0Bar		
货号 Item No.	叶轮 颜色 Impeller Color	喷嘴 颜色 Nozzle Color	流量 Discharge	射程直径 Standing Diameter	流量 Discharge	射程直径 Standing Diameter	流量 Discharge	射程直径 Standing Diameter	流量 Discharge	射程直径 Standing Diameter	流量 Discharge	射程直径 Standing Diameter
MS8050	蓝色 Blue	Green	28L/h	3.0m	32L/h	2.6m	34L/h	2.6m	38L/h	2.6m	41L/h	2.6m
MS8070		Blue	40L/h	2.6m	49L/h	2.8m	49L/h	3.0m	54L/h	3.2m	60L/h	3.2m
MS80100		Yellow	53L/h	2.6m	63L/h	2.8m	63L/h	3.6m	71L/h	4.4m	77L/h	4.8m
MS80120		Red	65L/h	4.0m	80L/h	5.0m	78L/h	5.0m	86L/h	5.0m	95L/h	5.0m
MS8150	绿色 Green	Green	28L/h	6.0m	32L/h	6.0m	34L/h	6.4m	38L/h	6.4m	41L/h	7.0m
MS8170		Blue	40L/h	6.0m	49L/h	6.4m	49L/h	6.4m	54L/h	6.4m	60L/h	6.6m
MS81100		Yellow	53L/h	6.4m	63L/h	6.4m	63L/h	6.4m	71L/h	6.4m	77L/h	7.0m
MS81120		Red	65L/h	6.0m	80L/h	6.4m	78L/h	6.4m	86L/h	7.0m	95L/h	7.0m

备注：地插高地面垂直距离为 1 米，倒挂高地面垂直距离 1 米，无风条件下测试

旋转微喷头和折射喷头 Microsprinkler & Microjet

产品名称 Product Description	图片 Picture	货号 Item No.	规格 Size	每袋数量 Qty/Bag (Pc)	每箱数量 Qty/Ctn (Pc)	纸箱规格 Ctn Size (Cm)	毛重 G.W (Kg)
折射式雾化微喷头 Microjet		MJ1201- MJ1204	Dn7	100	3600	54*35*28	16
防虫式全圆折射微喷头 Anti-Insect Microjet		MJ4002- MJ4007	Dn7	100	4600	54*35*28	14

Technical Data:

货号 Item No.	喷嘴颜色 Nozzle Color	工作压力 Working Pressure	1.5Bar	2.0Bar	2.5Bar	3.0Bar
MJ1201	Black	流量 Discharge	24.6L/h	28L/h	3.1L/h	3.4L/h
		倒挂直径 Hanged Diameter	2.0m-2.2m			
		地插直径 Standing Diameter	1.8m-2.0m			
MJ1202	Blue	流量 Discharge	39L/h	44L/h	49L/h	54L/h
		倒挂直径 Hanged Diameter	2.2m-2.4m			
		地插直径 Standing Diameter	2.0m-2.2m			
MJ1203	Green	流量 Discharge	58.5L/h	66.6L/h	75L/h	82.5L/h
		倒挂直径 Hanged Diameter	2.4m-2.6m			
		地插直径 Standing Diameter	2.2m-2.4m			
MJ1204	Red	流量 Discharge	73.5L/h	82.8L/h	93.9L/h	103.5L/h
		倒挂直径 Hanged Diameter	2.6m-2.8m			
		地插直径 Standing Diameter	2.4m-2.6m			

工作压力 Working Pressure		1.5Bar		2.0Bar		2.5Bar		3.0Bar	
货号 Item No.	喷嘴颜色 Nozzle Color	流量 Discharge	直径 Diameter	流量 Discharge	直径 Diameter	流量 Discharge	直径 Diameter	流量 Discharge	直径 Diameter
MJ4002	Gray	42.20L/h	2.2m	47.50L/h	2.6m	51.70L/h	2.8m	58.40L/h	3.0m
MJ4003	Black	59.00L/h	2.6m	68.60L/h	3.0m	76.20L/h	3.2m	83.20L/h	3.4m
MJ4004	Green	79.30L/h	3.0m	97.00L/h	3.4m	100.60L/h	3.8m	106.20L/h	4.2m
MJ4005	Blue	96.20L/h	3.4m	109.40L/h	4.0m	123.00L/h	4.2m	126.10L/h	4.4m
MJ4006	Red	128.00L/h	4.0m	144.80L/h	4.4m	155.80L/h	4.6m	179.00L/h	5.0m
MJ4007	Yellow	149.00L/h	4.2m	168.00L/h	4.6m	189.60L/h	5.0m	213.60L/h	5.2m

8908 131 8792

雾化喷头 Fogger & Mister
*KOM-60
6 ym*

产品名称 Product Description	图片 Picture	货号 Item No.	规格 Size	每袋数量 Qty/Bag (Pc)	每箱数量 Qty/Ctn (Pc)	纸箱规格 Ctn Size (Cm)	毛重 G.W (Kg)
四出口雾化喷头 4 Outlet Fogger		MJ1301A	绿色喷嘴 Green Nozzle	100	1200	54*35*28	18
		MJ1301B	灰色喷嘴 Grey Nozzle	100	1200	54*35*28	18
三出口雾化喷头 3 Outlet Fogger		MJ1301AT	绿色喷嘴 Green Nozzle	100	1200	54*35*28	18
		MJ1301BT	灰色喷嘴 Grey Nozzle	100	1200	54*35*28	18
一出口雾化喷头 One Outlet Fogger		MJ1311	黑色喷嘴 Black Nozzle	100	10000	54*35*28	26
		MJ1312	灰色喷嘴 Grey Nozzle	100	10000	54*35*28	26
一出口雾化喷头 Mist Sprager		MT0108T	红色喷嘴 1/4" Thread Red Nozzle	100	7000	54*35*28	19
弯喷头 Elbow Mister		MT0208	黑色喷嘴 Black Nozzle	100	11000	54*35*28	17
螺口式全圆 折射喷头 Microjet		MJ1412	62L/h@2bar	500	24000	42*28*21	14

技术参数 Technical Data:

货号 Item No.	工作压力 Working Pressure				
		2.5Bar	3.0Bar	3.5Bar	4.0Bar
MJ1301A	流量 Discharge	26L/h	28L/h	30L/h	31L/h
	倒挂直径 Hanged Diameter	1.6-2.0m			
MJ1301B	流量 Discharge	32L/h	35L/h	38L/h	40L/h
	倒挂直径 Hanged Diameter	1.6-2.0m			
MJ1301AT	流量 Discharge	20L/h	21L/h	23L/h	24L/h
	倒挂直径 Hanged Diameter	1.6-2.0m			
MJ1301BT	流量 Discharge	24L/h	25L/h	29L/h	30L/h
	倒挂直径 Hanged Diameter	1.6-2.0m			
MJ1311	流量 Discharge	8.0L/h	8.8L/h	9.5L/h	10.0L/h
	倒挂直径 Hanged Diameter	0.5-0.6m			
MJ1312	流量 Discharge	6.0L/h	6.7L/h	7.2L/h	7.7L/h
	倒挂直径 Hanged Diameter	0.4-2.0m			

货号 Item No.	工作压力 Working Pressure				
		1.5Bar	2.0Bar	2.5Bar	3.0Bar
MT0208	流量 Discharge	8.7L/h	9.3L/h	10.6L/h	11.8L/h
	射程直径 Standing Diameter	0.8-1.0m			
MT0104T	流量 Discharge	10L/h	14L/h	19L/h	23L/h
	射程直径 Standing Diameter	0.8-1.0m			
MT0108T	流量 Discharge	30L/h	36L/h	42L/h	50L/h
	射程直径 Standing Diameter	1.6-1.8m			
MJ1412	流量 Discharge	53L/h	62L/h	70L/h	82L/h
	射程直径 Standing Diameter	2.2-2.4m			

微喷头配件 Accessory for Microspray

产品名称 Product Description	图片 Picture	货号 Item No.	规格 Size	每袋数量 Qty/Bag(Pc)	每箱数量 Qty/Ctn(Pc)	纸箱规格 Ctn Size(Cm)	毛重 G.W(Kg)
双边承插式防滴器 Mini Anti-drainage Valve		4100	Dn7 Socket	100	6000	54*35*28	19
单边倒刺防滴器 Mini Anti-drainage Valve		4101	Dn7 Barb*Socket	100	6500	54*35*28	20
双边承插式直接 Double Socket Adaptor		5140	Dn7	100	25000	54*35*28	19
一边承插一边倒刺直接 One Barbed Adaptor		5141	Dn7	100	30000	54*35*28	21
双边倒刺式直接 Double Barbed Adapter		5142	Dn7	100	30000	54*35*28	21
内承插式单边倒刺直接 One Inside Barbed Adaptor		5145	Dn7	100	14000	54*35*28	21
双边内承插式接头 Double Inside Barbed Adaptor		5147	Dn7	100	14000	54*35*28	18

备注



- 防滴器可有效的控制倒挂微喷头配件在阀门关紧停水情况下，确保微喷头不滴水，从而有效保护作物。
- 当系统压力高于 0.7-1.0bar 时，水量通过防滴器微喷头开始喷水。
- 当系统压力低于 0.4-0.8bar 时，水量停止通过防滴器微喷头停止喷水。

Note:

- The Mini Anti-drainage vane can prevent the water from leaking the ground and prevent the little planting when microsprinkler or microjet is handed.
- When the pressure in system is up to 0.7-1.0bar, water flow through the Mini Anti-drainage valve.
- When the pressure in system is less than 0.4bar-0.8bar, water would be prevented by mini anti-drainage valve.





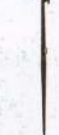

微喷头配件 Accessory for Microspray

产品名称 Product Description	图片 Picture	货号 Item No.	规格 Size	每袋数量 Qty/Bag (Pc)	每箱数量 Qty/Ctn (Pc)	纸箱规格 Ctn Size (Cm)	毛重 G.W (Kg)
重锤 Weight Hammer		5321	6cm 长 6cm Length	10	350	42*28*21	16
管上式堵头 Repairing End Line		5205	Dn6	50	20000	42*28*21	13
外螺纹变接头 Reducing Connector with Male Threaded		5194	Dn7*1/2"	100	3500	54*35*28	18
内螺纹变接头 Micro Spray Female Adaptor		SAT10T	1/4" *1/2"	100	2000	54*35*28	16
		SAT10B	Dn6*1/2"	100	2000	54*35*28	16
内螺纹长嘴接头 Micro Spray Female Adaptor		CHS250	Dn6*3/4"	100	1400	54*35*28	16
卡扣地插 Clip stake		CS0133	33cm 长 33cm Length	10	400	54*35*28	10
		CS0143	43cm 长 43cm Length	10	300	54*35*28	11
直立式地插 Straight Stake		SS0330	30cm 长 30cm Length	10	400	54*35*28	9
		SS0340	40cm 长 40cm Length	10	350	54*35*28	11
直立式地插 Straight Stake		SS0150	50cm 长 50cm Length	10	320	54*35*28	12



微喷头配件 Accessory for Microspray

产品名称 Product Description	图片 Picture	货号 Item No.	规格 Size	每袋数量 Qty/Bag (Pc)	每箱数量 Qty/Ctn (Pc)	纸箱规格 Ctn Size (Cm)	毛重 G.W (Kg)
倒挂三件套 Microsprinkler Hanged Support Set		HMS01	50cm 长 50cm Length	10	400	54*35*28	19
防滴倒挂三件套 Microsprinkler Hanged Support Set with Anti- drainage Valve		HMS02	50cm 长 50cm Length	10	400	54*35*28	26
地插三件套 Microsprinkler Support Stand Set		SMS0150	50cm 高 50cm 长 50cm Height 50cm Pipe	10	250	54*35*28	14
地插全套 地插微喷头 Microsprinkler Support Stand Set		SMS0230	30cm 高 50cm 长 30cm Height 50cm Pipe	10	250	54*35*28	14
		SMS0240	40cm 高 50cm 长 40cm Height 50cm Pipe	10	200	54*35*28	12
PVC 软管 PVC Soft Pipe		PV010474	Dn7 / 4mm, 4Bar	300 m/roll	3rolls/bag	Dn45*60	29



超十旋转喷头 Super Sprayer and Accessory

产品名称 Product Description	图片 Picture	货号 Item No.	规格 Size	每袋数量 Qty/Bag (Pc)	每箱数量 Qty/Ctn (Pc)	纸箱规格 Ctn Size (Cm)	毛重 G.W (Kg)
超十旋转喷头 Super Sprayer		SP3302	1/2"	10	300	54*35*28	15
		SP3303	1/2"	10	300	54*35*28	15
内螺丝支架接头 Support with Female Thread		5193	Dn12*1/2"	100	900	54*35*28	13
内螺纹地插接头 Support with Female Thread		ST5234	Dn16*3/4" Length:14.5cm	10	300	54*35*28	13
旁通接头 Offtake Connector		5191	Dn10*8	500	12000	54*35*28	16
承插接头 Barb Connector		5192	Dn12*8	100	8000	54*35*28	12
堵头 End Line		5195	Dn8	500	20000	54*35*28	16

货号 Item No.	工作压力 Working Pressure	1.5Bar	2.5Bar	3.0Bar	3.5Bar	4.0Bar
SP3302 (Blue Nozzle)	流量 Discharge	417L/h	465L/h	510L/h	545L/h	591L/h
	射程直径 Standing Diameter	15-16m				
SP3303 (Green Nozzle)	流量 Discharge	511L/h	567L/h	625L/h	673L/h	717L/h
	射程直径 Standing Diameter	17-18m				



塑料摇臂喷头 Plastic Impact Sprinkler

产品名称 Product Description	图片 Picture	货号 Item No.	规格 Size	每袋数量 Qty/Bag (Pc)	每箱数量 Qty/Ctn (Pc)	纸箱规格 Ctn Size (Cm)	毛重 G.W (Kg)
外螺纹摇臂喷头 Plastic Impact Sprinkler		RS5022	1/2" Male Thread	1	200	54*35*28	12
外螺纹摇臂喷头 Plastic Impact Sprinkler		RS5035	3/4" Male Thread	1	100	54*35*28	14

Technical Data:

喷嘴直径 喷嘴颜色 货号 Item No Nozzle Diameter Nozzle Color	压力 Pressure (bar)	单喷嘴流量 Single-nozzle Discharge (m ³ /h)	双喷嘴流量 Double-nozzle Discharge (m ³ /h)	射程 Spray Radius (m)	喷嘴直径 喷嘴颜色 货号 Item No Nozzle Diameter Nozzle Color	压力 Pressure (bar)	单喷嘴流量 Single-nozzle Discharge (m ³ /h)	双喷嘴流量 Double-nozzle Discharge (m ³ /h)	射程 Spray Radius (m)
RS5022-2 2.5+1.6 Purple+Brown	2 3 4	0.32 0.40 0.47	0.47 0.58 0.67	9.5 10.0 10.0	RS5035-2 4.0+3.0 Black+Grey	3 4 5	1.02 1.19 1.34	1.45 1.68 1.88	13.0 13.5 14.0
RS5022-3 2.8+1.6 Orange+Brown	2 3 4	0.42 0.52 0.60	0.55 0.70 0.81	9.5 10.0 10.0	RS5035-3 4.5+3.0 Brown+Grey	3 4 5	1.29 1.50 1.69	1.66 1.94 2.18	14.0 14.5 15.0
RS5022-4 3.0+1.6 Red+Brown	2 3 4	0.48 0.59 0.69	0.61 0.76 0.88	10.0 10.5 10.5	RS5035-4 5.0+3.0 Purple+Grey	3 4 5	1.58 1.84 2.07	1.95 2.28 2.56	14.5 15.0 16.0
RS5022-5 3.2+1.6 Green+Brown	2 3 4	0.54 0.68 0.79	0.68 0.85 0.99	10.5 10.5 11.0	RS5035-5 5.5+3.0 Orange+Grey	3 4 5	1.91 2.23 2.51	2.29 2.65 3.00	15.0 16.0 16.5
RS5022-6 3.5+1.6 Blue+Brown	2 3 4	0.64 0.80 0.94	0.78 0.97 1.14	10.5 11.0 11.0	RS5035-6 6.0+3.0 Red+Grey	3 4 5	2.21 2.57 2.90	2.57 3.00 3.38	15.0 16.5 17.0
RS5022-7 4.0+1.6 Black+Brown	2 3 4	0.82 1.03 1.22	0.95 1.20 1.43	11.0 11.5 11.5	RS5035-7 6.5+3.0 Gray+Grey	3 4 5	2.55 2.97 3.35	2.92 3.40 3.83	16.0 17.0 17.5



LDPE 软管

- 采用优质聚乙烯原料生产，同时添加抗 UV 和抗老化剂更加耐用。
- 公制，有多种规格和压力等级可供选择。
- 主要运用于灌溉系统中的主管道和分支管道。

LDPE Tubing

- Polyethylene hose manufactured from the highest grade of polyethylene resins, which provide maximum resistance to UV degradation and stress cracking.
- Various diameters, coil lengths and working pressure are available for selection.
- Ideal for installation of mainline and sub-line in irrigation system.













产品名称 Product Description	货号 Item No.	产品名称 Product Description	单位 Unit	包装 Package (m/roll)	包装规格 Package Size (Cm)	毛重 G.W (Kg)
	LP010605	Dn6 , 0.5mm , 4.0Bar	m	1000	Dn40*40	11
	LP010610	Dn6 , 1mm , 6.0Bar	m	1000	Dn40*40	17
	LP010806	Dn8 , 0.6mm , 2.5Bar	m	800	Dn50*42	13
	LP010808	Dn8 , 0.8mm , 4.0Bar	m	800	Dn50*42	16
	LP010812	Dn8 , 1.2mm , 6.0Bar	m	800	Dn50*42	21
	LP011208	Dn12 , 0.8mm , 2.5Bar	m	500	Dn70*30	16
	LP011210	Dn12 , 1mm , 4.0Bar	m	500	Dn70*30	19
	LP011214	Dn12 , 1.4mm , 6.0Bar	m	500	Dn70*30	25
	LP011610	Dn16 , 1mm , 2.5Bar	m	500	Dn90*30	26
	LP011612	Dn16 , 1.2mm , 4.0Bar	m	500	Dn90*30	27
	LP011616	Dn16 , 1.6mm , 6.0Bar	m	500	Dn90*30	38
	LP012012	Dn20 , 1.2mm , 2.5Bar	m	200	Dn75*30	15
	LP012015	Dn20 , 1.5mm , 4.0Bar	m	200	Dn75*30	18
	LP012020	Dn20 , 2mm , 6.0Bar	m	200	Dn75*30	23
	LP012514	Dn25 , 1.4mm , 2.5Bar	m	200	Dn90*35	22
	LP012519	Dn25 , 1.9mm , 4.0Bar	m	200	Dn90*35	29
	LP012523	Dn25 , 2.3mm , 6.0Bar	m	200	Dn90*35	33
	LP021613	外白内黑 White Color Outside Dn16 , 1.3mm , 4.0Bar	m	500	Dn90*30	26

备注：外层白色 PE 管可以有效防止太阳曝晒下管内水温升高，避免烫伤作物

Note: Under the sun exposure, the PE pipe with white color outside can be effective to prevent water from high temperature and avoid to hurt the crops.

微灌管用配件 Fitting for Tubing

产品名称 Product Description	图片 Picture	货号 Item No.	规格 Size	每袋数量 Qty/Bag	每箱数量 Qty/Ctn (Pc)	纸箱规格 Ctn Size (Cm)	毛重 G.W (Kg)
管用旁通接头 Offtake for PE Pipe		OP0112	Dn12	100	4500	54*35*28	19
		OP0116	Dn16	100	3500	54*35*28	19
		OP0120	Dn20	100	1800	54*35*28	18
管用旁通接头 (带双层胶圈) Offtake for PVC Pipe		OP0112R	Dn12	100	2800	54*35*28	22
		OP0116R	Dn16	100	2300	54*35*28	18
		OP0120R	Dn20	100	1400	54*35*28	19
新款管用旁通接头 (带双层胶圈) New Type Offtake for PVC Pipe		OP0216R	Dn16	100	1800	54*35*28	16
PVC 管用旁通三通 Offtake Tee for PVC Pipe		OT0116R	Dn16	100	1300	54*35*28	10
管用倒刺直通 Straight Connector		SC0116	Dn16	100	2800	54*35*28	18
		SC0120	Dn20	100	1100	54*35*28	17
		SC0125	Dn25	100	1000	54*35*28	15
管用变接头 Reducing Connector		RC011612	Dn16*12	100	2800	54*35*28	19
		RC012016	Dn20*16	100	1200	54*35*28	11
外螺纹管用接头 Male Threaded Connector		MC011612	Dn16*1/2"	100	2100	54*35*28	15
		MC011634	Dn16*3/4"	100	1200	54*35*28	13
		MC012012	Dn20*1/2"	100	1600	54*35*28	17
		MC012034	Dn20*3/4"	100	1000	54*35*28	11
		MC012534	Dn25*3/4"	100	1000	54*35*28	12
内螺纹管用接头 Female Threaded Connector		FC011612	Dn16*1/2"	100	1000	54*35*28	16
		FC011634	Dn16*3/4"	100	800	54*35*28	14
涂塑软管旁通接头 Barb Connector for Lay Flat Hose		BL0116	Dn16	50	700	54*35*28	17
		BL0120	Dn20	50	600	54*35*28	18
管用倒刺弯头 Elbow Connector		EC0116	Dn16	100	2100	54*35*28	10
		EC0120	Dn20	50	1200	54*35*28	12
		EC0125	Dn25	50	700	54*35*28	10
外螺纹管用倒刺弯头 Elbow With Male Thread		EC021612	Dn16*1/2"	100	1500	54*35*28	15

产品名称 Product Description	图片 Picture	货号 Item No.	规格 Size	每袋数量 Qty/Bag (Pc)	每箱数量 Qty/Ctn (Pc)	纸箱规格 Ctn Size (Cm)	毛重 G.W (Kg)
管用倒刺三通 Tee Connector		TC0116	Dn16	100	1300	54*35*28	10
		TC0120	Dn20	50	700	54*35*28	10
		TC0125	Dn25	50	400	54*35*28	9
折叠式管用堵头 End Line		EL0116	Dn16	100	3000	54*35*28	11
		EL0120	Dn20	100	1600	54*35*28	12
承插式管用堵头 Barb End Line		EL0216	Dn16	100	4000	54*35*28	19
		EL0220	Dn20	100	2000	54*35*28	19
双边外丝接头 Nipple		NP0112	1/2"	100	1800	54*35*28	14
		NP0134	3/4"	100	1000	54*35*28	13
		NP0110	1"	50	500	54*35*28	13
		NP0132	1-1/2"	6	240	54*35*28	11
		NP0150	2"	5	160	54*35*28	12
地插固定支架 Holddown Support		HS0112	Dn12	100	1400	54*35*28	9
		HS0216	Dn16	100	4000	54*35*28	28
夹紧圈 Safety Ring		SR0116	Dn16	100	2800	42*28*21	5
悬挂固定管夹 Hanging Clamp for PE pipe		HC0116	Dn16	100	2200	42*28*21	8
地插支架 Support Stake, 8cm Length		SS0407	Dn7 8cm	100	5000	42*28*21	6
多用途地插固定支架 Multiple Support, 15cm Length		MS0137	3*7mm 15cm	100	2200	42*28*21	9
涂塑软管旁通接头 Starter Connector for Layflat		SC013812	3/8" *1/2"	100	1000	54*35*28	17
双层胶圈 H Grommet		RR011608	Dn16*8	500	7500	54*35*28	20
大双层胶圈 H Grommet		RR011610	Dn16*10	500	6000	54*35*28	18
单层胶圈 T Grommet		RR021608	Dn16*8	500	6000	54*35*28	19

微灌管用阀门 Mini Valve for Tubing

产品名称 Product Description	图片 Picture	货号 Item No.	规格 Size	每袋数量 Qty/Bag (Pc)	每箱数量 Qty/Ctn (Pc)	纸箱规格 Ctn Size (Cm)	毛重 G.W (Kg)
承插直通阀门 Maxi Valve		MV0116	Dn16	50	600	54*35*28	15
		MV0120	Dn20	50	550	54*35*28	14
外螺纹承插阀门 Thread-barb Valve		TV011216	Dn1/2"*16	50	550	54*35*28	16
		TV011220	Dn1/2"*20	50	550	54*35*28	14
		TV013416	Dn3/4"*16	50	450	54*35*28	14
		TV013420	Dn3/4"*20	50	450	54*35*28	14
双头外螺纹阀门 Threaded Male-Male Valve		MM0134	3/4"*3/4"	50	400	54*35*28	14
内外螺纹阀门 Threaded Male-Female Valve		MF011212	1/2"*1/2"	50	400	54*35*28	13
		MF013434	3/4"*3/4"	50	350	54*35*28	15
内螺纹承插阀门 Barb-Female Thread Valve		BF011612	Dn16*1/2"	50	400	54*35*28	13
		BF011634	Dn16*3/4"	50	400	54*35*28	13
承插旁通阀门 (带单层胶圈) Barb Offtake Valve With Rubber Ring		OV0416R	Dn16	50	550	54*35*28	16
承插锁扣旁通阀门 Barb Lock Offtake Valve		OV0516	Dn16	50	500	54*35*28	17
涂塑软管旁通阀门 Barb Offtake Valve for Layflat Hose		OV0716	Dn16	50	300	54*35*28	15
		OV0720	Dn20	50	300	54*35*28	15

管用配套工具及其他 Accessory Tooling for Tubing

产品名称 Product Description	图片 Picture	货号 Item No.	规格 Size	每袋数量 Qty/Bag (Pc)	每箱数量 Qty/Ctn (Pc)	纸箱规格 Ctn Size (Cm)	毛重 G.W (Kg)
冲洗阀 Flush Valve		FV0234	3/4",0.18bar	100	1200	54*35*28	13
管上式打孔器 Punch for On-line Dripper		PD0104	Dn4	100	3500	42*28*21	13
简易打孔器 Simple Punch		SP0103	Dn3	10	450	54*35*28	28
		SP0108	Dn8	10	450	54*35*28	28
握式打孔器 Handle Punch		SP250	Dn3	1	60	42*28*21	8
压力表外牙接头 Take Pressure Adaptor		TP0114	1/4"	100	2400	42*28*21	10
压力表快速接头 Steack for Gauge		SG0114	1/4"	100	4000	42*28*21	6
涂塑软管打孔器 Punch for Lay Flat Hose		PF0215	Dn15	1	50	42*28*21	9
		PF0217	Dn17	1	50	42*28*21	9



塑料过滤器 Plastic Filter

- 外壳采用优质复合塑料生产，耐压、抗冲击、坚固耐用。
- 过滤内芯有不锈钢网和叠片两种可供选择，适应不同需要。
- 可过滤不同水质，广泛应用于农业和工业的水处理。
- 多种标准规格可供选择，满足不同需求。
- 易于安装和操作。

- Housings made of very strong plastic, designed to resist great pressure which can be used for long time.
- Two size of filter element can be chose, one is stainless screen and the other size is disc which can meet different requirement.
- Can filter many kinds of water quality and apply for the water treatment both in Agriculture and Industry.
- Many sizes available can be met widely demands.
- Easy installation and operation.

小型塑料过滤器 Micro Plastic Filter

产品名称 Product Description	图片 Picture	货号 Item No.	规格 Size	每袋数量 Qty/Bag (Pc)	每箱数量 Qty/Ctn (Pc)	纸箱规格 Ctn Size (Cm)	毛重 G.W (Kg)
网式过滤器 120 目 Screen Filter, 120 Mesh		1725S120MBT	3/4"BSP 外螺纹	1	40	54*35*28	9
		1725S120MNT	3/4"NPT 外螺纹	1	40	54*35*28	9
		1725S120MHT	3/4"Hose 外螺纹	1	40	54*35*28	9
叠片过滤器 120 目 Disc Filter, 120 Mesh		1725D120MBT	3/4"BSP 外螺纹	1	40	54*35*28	12
		1725D120MNT	3/4"NPT 外螺纹	1	40	54*35*28	12
		1725D120MHT	3/4"Hose 外螺纹	1	40	54*35*28	12
网式过滤器 120 目 Screen Filter, 120 Mesh		1732S120MBT	1"BSP 外螺纹	1	40	54*35*28	11
		1732S120MNT	1"NPT 外螺纹	1	40	54*35*28	11
叠片过滤器 120 目 Disc Filter, 120 Mesh		1732D120MBT	1" BSP 外螺纹	1	40	54*35*28	12
		1732D120MNT	1" NPT 外螺纹	1	40	54*35*28	12
网式过滤器 Screen In-line Filter 120Mesh		1825S120FHF	3/4"*3/4"Hose 外螺纹 * 内螺纹	10	120	42*28*21	7

技术参数 Technical Data:





货号 Item No.	规格 Size	过滤模式 Filter Elements	过滤目数 Filtration Grade	过滤面积 Filter Surface (cm ²)	最大工作压力 Max.pressure (bar)	最大流量 Max.flow (m ³ /h)
1725S120M	3/4"	网式 / Screen	120 Mesh	90	10	5
1725D120M	3/4"	叠片 / Disc	120 Mesh	90	10	4
1732S120M	1"	网式 / Screen	120 Mesh	90	10	5
1732D120M	1"	叠片 / Disc	120 Mesh	90	10	4
1825S120FHT	3/4"	网式 / Screen	120 Mesh	17	8	1.8

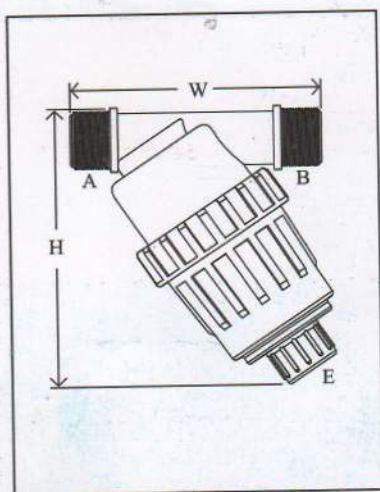



外观尺寸 Messure:

货号 Item No.	A	B	C	E	M	H(mm)	W(mm)	X(mm)	Weight(Kg)
1725S120M / 1725D120M	3/4"Male	3/4"Male	-	3/4"BSP	-	163	125	-	0.20 / 0.30
1732S120M / 1732D120M	1"Male	1"Male	-	1"BSP	-	168	134	-	0.20 / 0.30



中型塑料过滤器 Medium Plastic Filter

产品名称 Product Description	图片 Picture	货号 Item No.	规格 Size	每袋数量 Qty/Bag (Pc)	每箱数量 Qty/Ctn (Pc)	纸箱规格 Ctn Size (Cm)	毛重 G.W (Kg)
T 型网式过滤器 120 目 T Screen Filter, 120 Mesh		T1763S120B	2"BSP 外螺纹 2" BSP Male Thread	1	10	54*35*28	9
		T1763S120N	2"NPT 外螺纹 2" NPT Male Thread	1	10	54*35*28	9
T 型叠片过滤器 120 目 T Disc Filter, 120mesh		T1763D120B	2"BSP 外螺纹 2"BSP Male Thread	1	10	54*35*28	12
		T1763D120N	2"NPT 外螺纹 2" NPT Male Thread	1	10	54*35*28	12
T 型网式过滤器 120 目 T Screen Filter, 120mesh		T1750S120B	1-1/2"BSP 外螺纹 1-1/2" BSP Male Thread	1	10	54*35*28	7
		T1750S120N	1-1/2"BSP 外螺纹 1-1/2"NPT Male Thread	1	10	54*35*28	7
T 型叠片过滤器 120 目 T Disc Filter, 120mesh		T1750D120B	1-1/2"BSP 外螺纹 1-1/2" BSP Male Thread	1	10	54*35*28	12
		T1750D120N	1-1/2"BSP 外螺纹 1-1/2" BSP Male Thread	1	10	54*35*28	12
Y 型网式过滤器, 120 目 Y Screen Filter, 120mesh		Y1750S120B	1-1/2" BSP 外螺纹 1-1/2" BSP Male Thread	1	7	54*35*28	7
Y 型叠片过滤器, 120 目 Y Disc Filter, 120mesh		Y1750D120B	1-1/2" BSP 外螺纹 1-1/2" BSP Male Thread	1	7	54*35*28	10

产品名称 Product Description	图片 Picture	货号 Item No.	规格 Size	每袋数量 Qty/Bag (Pc)	每箱数量 Qty/Ctn (Pc)	纸箱规格 Ctn Size (Cm)	毛重 G.W (Kg)
Y型网式过滤器, 120目 Y Screen Filter, 120mesh		Y1763S120B	2" BSP 外螺纹 2" BSP Male Thread	1	7	54*35*28	7
Y型叠片过滤器, 120目 Y Disc Filter, 120mesh		Y1763D120B	2" BSP 外螺纹 2" BSP Male Thread	1	7	54*35*28	10
Y型加大网式过滤器, 120目 Y Super Screen Filter, 120mesh		YB1763S120B	2" BSP 外螺纹 2" BSP Male Thread	1	4	54*35*28	7
Y型加大叠片过滤器, 120目 Y Super Disc Filter, 120mesh		YB1763D120B	2" BSP 外螺纹 2" BSP Male Thread	1	4	54*35*28	8



中型塑料过滤器 Plastic Filter

技术参数 Technical Data:

货号 Item No.	规格 Size	过滤模式 Filter Elements	过滤目数 Filtration Grade	过滤面积 Filter Surface (cm ²)	最大工作压力 Max.pressure (bar)	最大流量 Max.flow (m ³ /h)
T1763S120B/N	2" 外螺纹	网式 / Screen	120 Mesh	246	8	11
T1763D120B/N	2" 外螺纹	叠片 / Disc	120 Mesh	254	8	10
T1750S120B/N	1-1/2" 外螺纹	网式 / Screen	120 Mesh	246	8	11
T1750D120B/N	1-1/2" 外螺纹	叠片 / Disc	120 Mesh	254	8	10
Y1750S120B	1-1/2" 外螺纹	网式 / Screen	120 Mesh	480	6	13
Y1750D120B	1-1/2" 外螺纹	叠片 / Disc	120 Mesh	577	6	13
Y1763S120B	2" 外螺纹	网式 / Screen	120 Mesh	480	6	13
Y1763D120B	2" 外螺纹	叠片 / Disc	120 Mesh	577	6	13
YB1763S120B	2" 外螺纹	网式 / Screen	120 Mesh	763	6	18
YB1763D120B	2" 外螺纹	叠片 / Disc	120 Mesh	879	6	18

外观尺寸 Measure:

货号 Item No.	A	B	C	E	M	H(mm)	W(mm)	X(mm)	Weight(Kg)
T1763S120B/T1763D120B	2"BSP	2"BSP	-	3/4"BSP	1/4"BSP	341	222	-	0.90 / 1.10
T1763S120N/T1763D120N	2"NPT	2"NPT	-	3/4"BSP	1/4"BSP	341	222	-	0.90 / 1.10
T1750S120B/T1750D120N	1-1/2"BSP	1-1/2"BSP	-	3/4"BSP	1/4"BSP	328	205	-	0.80 / 1.00
T1750S120N/T1750D120N	1-1/2"NPT	1-1/2"NPT	-	3/4"BSP	1/4"BSP	328	205	-	0.80 / 1.00
Y1763S120B/Y1763D120B	2"BSP	2"BSP	-	3/4"BSP	1/4"BSP	260	284	260	0.88 / 1.25
YB1763S120B/YB1763D120B	2"BSP	2"BSP	-	3/4"BSP	1/4"BSP	316	338	290	1.38 / 1.75
Y1750S120B/Y1750D120B	1-1/2"BSP	1-1/2"BSP	-	3/4"BSP	1/4"BSP	163	140	240	0.87 / 1.24

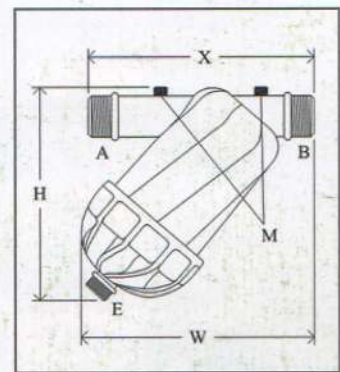
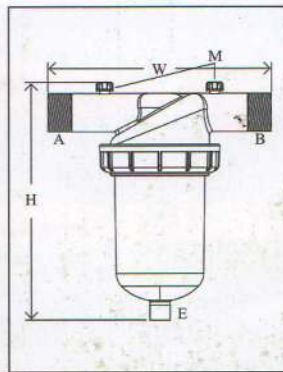

大流量塑料过滤器 Large Plastic Filter

产品名称 Product Description	图片 Picture	货号 Item No.	规格 Size	每袋数量 Qty/Bag (Pc)	每箱数量 Qty/Ctn (Pc)	纸箱规格 Ctn Size (Cm)	毛重 G.W (Kg)
2" 叠片过滤器 120目 2" Disc Filter, 120Mesh		FD02120B	2" BSP 外螺纹 2" BSP Male Thread	1	1	63*23*33	7
		FD02120N	2" NPT 外螺纹 2" NPT Male Thread	1	1	63*23*33	7
2" 网式过滤器 120目 2" Screen Filter, 120Mesh		FS02120B	2"BSP 外螺纹 2" BSP Male Thread	1	1	63*23*33	6
		FS02120N	2"NPT 外螺纹 2" NPT Male Thread	1	1	63*23*33	6
3" 叠片过滤器 120目 3" Disc Filter, 120Mesh		FD03120BBB	3"BSP*3"BSP*3"BSP 外螺纹 3"BSP*3"BSP*3"BSP Male Thread	1	1	76*36*24	10
		FD03120VVB	3" 卡扣 *3" 卡扣 *3"BSP 外螺纹 3"VIC*3"VIC*3"BSP Male Thread	1	1	76*36*24	10
		FD03120VBV	3" 卡扣 *3"BSP 外螺纹 *3" 卡扣 3"VIC*3"BSP Male Thread*3"VIC	1	1	76*36*24	10
3" 网式过滤器, 120目 3" Screen Filter, 120Mesh		FS03120BBB	3"BSP*3"BSP*3"BSP 外螺纹 3"BSP*3"BSP*3"BSP Male Thread	1	1	76*36*24	8
		FS03120VVB	3" 卡扣 *3" 卡扣 *3"BSP 外螺纹 3"VIC*3"VIC*3"BSP Male Thread	1	1	76*36*24	8
		FS03120VBV	3" 卡扣 *3"BSP 外螺纹 *3" 卡扣 3"VIC*3"BSP Male Thread*3"VIC	1	1	76*36*24	8
4" 叠片过滤器, 120目 4" Disc Filter, 120Mesh		FD04120BB	4"BSP*4"BSP 外螺纹 4"BSP*4"BSP Male Thread	1	1	100*38*24	12
		FD04120VV	4" 卡扣 *4" 卡扣 4"VIC*4"VIC	1	1	100*38*24	12
4" 网式过滤器, 120目 4" Screen Filter, 120Mesh		FS04120BB	4"BSP*4"BSP 外螺纹 4"BSP*4"BSP Male Thread	1	1	100*38*24	8
		FS04120VV	4" 卡扣 *4" 卡扣 4"VIC*4"VIC	1	1	100*38*24	8
4" 加长叠片过 滤器,120目 4" Super Disc Filter, 120Mesh		FD04S120BB	4"BSP*4"BSP 外螺纹 4"BSP*4"BSP Male Thread	1	1	125*38*24	14
		FD04S120VV	4" 卡扣 *4" 卡扣 4"VIC*4"VIC	1	1	125*38*24	14
4" 加长网式 过滤器,120目 4" Super Screen Filter, 120Mesh		FS04S120BB	4"BSP*4"BSP 外螺纹 4"BSP*4"BSP Male Thread	1	1	125*38*24	12
		FS04S120VV	4" 卡扣 *4" 卡扣 4"VIC*4"VIC	1	1	125*38*24	12

大流量塑料过滤器 Large Plastic Filter

技术参数 Technical Data:

货号 Item No.	规格 Size	过滤模式 Filter Elements	过滤目数 Filtration Grade	过滤面积 Filter Surface (cm ²)	最大工作压力 Max.pressure (bar)	最大流量 Max.flow (m ³ /h)
FD02120B/N	2"	叠片 / Disc	120 Mesh	1200	10	30
FS02120B/N	2"	网式 / Screen	120 Mesh	965	10	30
FD03120BBB/ VVB/VBV	3"	叠片 / Disc	120 Mesh	1700	10	50
FS03120BBB/ VVB/VBV	3"	网式 / Screen	120 Mesh	1090	10	50
FD04120BB/VV	4"	叠片 / Disc	120 Mesh	2400	10	70
FS04120BB/VV	4"	网式 / Screen	120 Mesh	1930	10	70
FD04S120BB/ VV	4"Super	叠片 / Disc	120 Mesh	3400	10	100
FS04S120BB/ VV	4"Super	网式 / Screen	120 Mesh	2180	10	100

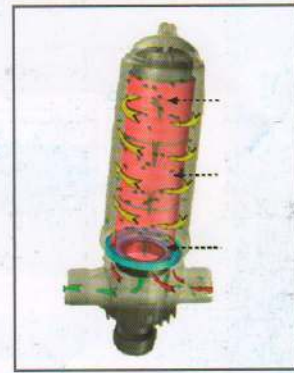
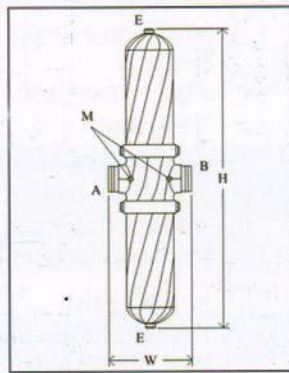
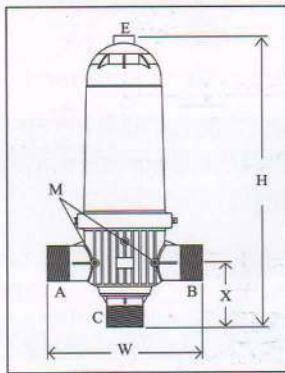



外观尺寸 Messure:

货号 Item No.	A	B	C	E	M	H(mm)	W(mm)	X(mm)	Weight(Kg)
FD02120B / FS02120B	2"BSP	2"BSP	2"BSP	3/4"BSP	1/4"BSP	595	324	138	7.00 / 6.00
FD02120N / FS02120N	2"NPT	2"NPT	2"NPT	3/4"BSP	1/4"NPT	595	324	138	7.00 / 6.00
FD03120BBB / FS03120BBB	3"BSP	3"BSP	3"BSP	3/4"BSP	1/4"BSP	727	336	147	7.70 / 6.70
FD03120VVB / FS03120VVB	3"VIC	3"VIC	3"BSP	3/4"BSP	1/4"BSP	727	336	147	7.70 / 6.70
FD03120VBV / FS03120VBV	3"VIC	3"BSP	3"VIC	3/4"BSP	1/4"BSP	727	336	147	7.70 / 6.70
FD04120BB / FS04120BB	4"BSP	4"BSP	-	3/4"BSP	1/4"BSP	950	342	-	11.60/8.70
FD04120VV / FS04120VV	4"VIC	4"VIC	-	3/4"BSP	1/4"BSP	950	342	-	11.60/8.70
FD04S120BB / FS04S120BB	4"BSP	4"BSP	-	3/4"BSP	1/4"BSP	1200	342	-	14.00
FD04S120VV / FS04S120VV	4"VIC	4"VIC	-	3/4"BSP	1/4"BSP	1200	342	-	14.00

自动反冲洗过滤器 Automatic Self-Cleaning Filter

- 自动反冲洗过滤器具有自动清洗功能，极大提高过滤效率。
- 反冲洗所需水量少和压力低，节水节能。
- 采用离心设计，冲洗更高效，维护更方便。
- 采用独特设计和优质材料，过滤和反冲洗工作稳定，可靠性强。
- 结构紧凑，便于运输和安装。
- 可与多种控制器兼容，便于操作。
- Automatic Self-cleaning Filter with maximum reliability and efficiency in filtration.
- Water and energy saving. Minimum backflushing pressure for maximum efficiency and using minimum water maintaining an efficient cleaning action.
- The helical action optimizes the filtration performance and reduces backwash frequency and maintenance.
- Specially designed and high quality materials used in manufacturing guarantees an extended life with high resistance.
- Compact assembled systems for easy transportation and installation.
- Compatible with various control units, easy operation

产品名称 Product Description	图片 Picture	货号 Item No.	规格 Size	每袋数量 Qty/Bag (Pc)	每箱数量 Qty/Ctn (Pc)	纸箱规格 Ctn Size (Cm)	毛重 G.W (Kg)
2" 加长自动反冲洗片过滤器, 120目 2" Super Automatic Self-cleaning Disc Filter, 120Mesh		AFD02S120BBB	2"BSP*2"BSP*2"BSP 外螺纹 2"BSP*2"BSP*1"BSP Male Thread	1	1	76*36*24	9
		AFD02S120VVB	2" 卡扣 *2" 卡扣 *2"BSP 外螺纹 2"VIC*2"VIC*2"BSP Male Thread	1	1	76*36*24	9
		AFD02S120VBV	2" 卡扣 *2"BSP 外螺纹 *2" 卡扣 2"VIC*2"BSP Male Thread*2"VIC	1	1	76*36*24	9
3" 自动反冲洗叠片过滤器, 120目 3" Automatic Self-cleaning Disc Filter, 120Mesh		AFD03120BBB	3"BSP*3"BSP*3"BSP 外螺纹 3"BSP*3"BSP*1.5BSP Male Thread	1	1	76*36*24	10
		AFD03120VVB	3" 卡扣 *3" 卡扣 *3"BSP 外螺纹 3"VIC*3"VIC*3"BSP Male Thread	1	1	76*36*24	10
		AFD03120VBV	3" 卡扣 *3"BSP 外螺纹 *3" 卡扣 3"VIC*3"BSP Male Thread*3"VIC	1	1	76*36*24	10
4" 加长自动反冲洗叠片过滤器, 120目 4" Super Automatic Self-cleaning Disc Filter, 120Mesh		AFD04S120BB	4"BSP*4"BSP 外螺纹 4"BSP*4"BSP Male Thread	1	1	125*38*24	17
		AFD04S120VV	4" 卡扣 *4" 卡扣 4"VIC*4"VIC	1	1	125*38*24	17

自动反冲洗过滤器 Automatic Self-Cleaning Filter

技术参数 Technical Data:

货号 Item No.	规格 Size	过滤模式 Filter Elements	过滤目数 Filtration Grade	过滤面积 Filter Surface (cm ²)	最大工作压力 Max.pressure (bar)	最大流量 Max.flow (m ³ /h)
AFD02S120BBB/VVB/VBV	2"	叠片 / Disc	120 Mesh	1650	10	50
AFD03120BBB/VVB/VBV	3"	叠片 / Disc	120 Mesh	1650	10	50
AFD04120BB/VV	4"	叠片 / Disc	120 Mesh	3300	10	100

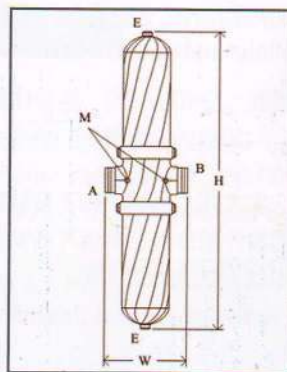
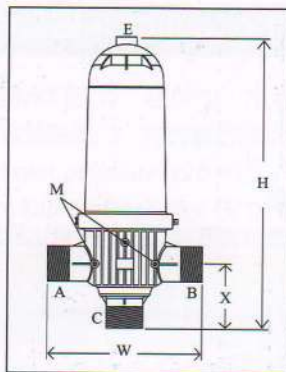

外观尺寸 Measure:

货号 Item No.	A	B	C	E	M	H(mm)	W(mm)	X(mm)	Weight(Kg)
AFD02S120BBB	2"BSP	2"BSP	2"BSP	3/4"BSP	1/4"BSP	721	324	138	8.10
AFD02S120VVB	2"VIC	2"VIC	2"BSP	3/4"BSP	1/4"BSP	721	324	138	8.10
AFD02S120VBV	2"VIC	2"BSP	2"VIC	3/4"BSP	1/4"BSP	721	324	138	8.10
AFD03120BBB	3"BSP	3"BSP	3"BSP	3/4"BSP	1/4"BSP	727	336	147	8.50
AFD03120VVB	3"VIC	3"VIC	3"BSP	3/4"BSP	1/4"BSP	727	336	147	8.50
AFD03120VBV	3"VIC	3"BSP	3"VIC	3/4"BSP	1/4"BSP	727	336	147	8.50
AFD04S120BB	4"BSP	4"BSP	-	3/4"BSP	1/4"BSP	1200	342	-	15.00
AFD04S120VV	4"VIC	4"VIC	-	3/4"BSP	1/4"BSP	1200	342	-	15.00

自动反冲洗流量和压力参数 Automatic Backflushing Data

货号 Item No.	AFD02S120BBB/ VVB / VBV	AFD03120BBB/ VVB / VBV	AFD04120BB / VV
最低反冲洗工作压力 Minimum Backflushing Pressure (Bar)	2.50-3.00 Bar	2.50-3.00 Bar	2.50-3.00 Bar
最低反冲洗流量 Minimum Backflushing Flow (L/s)	2.50 L/s	2.50 L/s	5.00 L/s
反冲洗时间 (秒) Backflushing Time (s)	8-30s	8-30s	8-30s
反冲洗耗水量 Backflushing Consumption (L)	20-75 L	20-75 L	40-150 L

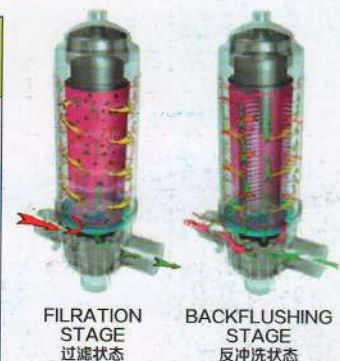

文丘里注肥器 Fertilizer Injector

特点 Advantage:

- 立体一次性成型，结构合理。
- 利用虹吸原理，方便吸入各种液态肥料并注入灌溉管道中，水肥均匀灌溉各种作物。
- 可与注肥器套件配合易于主管道相连接。
- 进出水口为外螺纹接头，方便连接。
- Commercial grade one with no moving parts.
- It works by suction and will draw liquid fertilizer out of almost any container you provide.
- Can be plumbed on a bypass for less restriction(the preferred method),or directly into a main water line.
- All sizes have Male Pipe threads on the inlet and outlet, which are easily adapted to hose threads.

应用 Application:

- 按作物及灌溉面积挑选相应规格注肥器，太大或太小都不利于有效施肥。
- 如无法确定时，挑选规格小的然后与注肥套件配合与主管道并联安装通过调整阀门控制水量达到注肥目的；如果确定注肥器偏小可通过阀门调小水量通过延长时间达到施肥目的。
- Select the appropriate specification of fertilizer Injector depend on the crop and irrigation area. Too big or too small maybe do nothing.
- If in doubt always choose a smaller size, put it on a bypass assembly which allows you to adjust the flow through the venturi injector and does not restrict the flow as much.

产品名称 Product Description	图片 Picture	货号 Item No.	规格 Size	每袋数量 Qty/Bag (Pc)	每箱数量 Qty/Ctn (Pc)	纸箱规格 Ctn Size (Cm)	毛重 G.W (Kg)
文丘里式注肥器 Venturi Injector		VI0112H	1/2"	10	300	54*35*28	11
		VI0134H	3/4"	10	250	54*35*28	11
		VI0110H	1"	10	100	54*35*28	12
		VI0132H	1-1/2"	1	40	54*35*28	9
		VI0150H	2"	1	25	54*35*28	8
过滤吸管套件 Suction Assembly		SA011234	1/2" or 3/4"	1	60	54*35*28	9
		SA011032	1" or 1-1/2"	1	20	54*35*28	9
		SA0120	2"	1	10	54*35*28	10

技术参数 Technical Data:

货号 Item No.	规格 Size	At0.8bar		At1.0bar		At1.5bar		At2.0bar		At2.5bar		At3.0bar		At3.5bar		At4.0bar	
		出水量 Outlet Flow (L/h)	吸水量 Injection Rate (L/h)	出水量 Outlet Flow (L/h)	吸水量 Injection Rate (L/h)	出水量 Outlet Flow (L/h)	吸水量 Injection Rate (L/h)	出水量 Outlet Flow (L/h)	吸水量 Injection Rate (L/h)	出水量 Outlet Flow (L/h)	吸水量 Injection Rate (L/h)	出水量 Outlet Flow (L/h)	吸水量 Injection Rate (L/h)	出水量 Outlet Flow (L/h)	吸水量 Injection Rate (L/h)	出水量 Outlet Flow (L/h)	吸水量 Injection Rate (L/h)
VI0112H	1/2"	280	63	305	70	353	74	389	74	420	71	448	71	447	72	501	72
VI0134H	3/4"	880	97	961	107	1098	114	1192	113	1292	113	1372	113	1462	113	1537	113
VI0110H	1"	1758	158	2112	244	2578	265	3043	357	3290	356	3691	352	3933	349	4203	351
VI0132H	1-1/2"	3540	544	4140	619	4980	787	5880	786	6480	785	6720	779	7704	778	8100	781

*备注：在 0.8-4.0 Bar 压力流量范围下有 50% 的水头损失。
 * Note: Flow Range at 0.8-4.0 Bar with 50% Pressure Differential.

压力调节阀 Pressure Regulator

特点 Advantage:

- 方便连接城市供水的水龙头，供水压力高时方便调节出水压力。
- 优质的 ABS 主体坚固耐用接头为内外牙有两种牙规可供选择。
- Ideal regulator for Low volume systems connected with outdoor faucets when the rural areas supply water at very high pressure.
- Impact resistant body, with 2 size of thread for choice.

应用范围 Application:

- 最大进水口压力：120PSI；压力调节范围：20-100PSI；流量范围：0.2-6.5GPM。
- 适用安装在阀门、定时器后面避免受到持续高水压的损坏。
- Max inlet pressure 120 PSI, Pressure range from 20-100 PSI and flow range: 0.2-6.5GPM
- Be installed after valve or timer; avoid to be damaged by constant high water pressure.

产品名称 Product Description	图片 Picture	货号 Item No.	规格 Size	每袋数量 Qty/Bag (Pc)	每箱数量 Qty/Ctn (Pc)	纸箱规格 Ctn Size (Cm)	毛重 G.W (Kg)
3/4" 低流量 压力调节阀 3/4" Low Flow Pressure Regulator		PR013415P	3/4" FPT*MPT 15PSI	10	200	48*28*21	8
		PR013415H	3/4" FHT*MHT 15PSI	10	200	48*28*21	8
		PR013420P	3/4" FPT*MPT 20PSI	10	200	48*28*21	8
		PR013420H	3/4" FHT*MHT 20PSI	10	200	48*28*21	8
		PR013425P	3/4" FPT*MPT 25PSI	10	200	48*28*21	8
		PR013425H	3/4" FHT*MHT 25PSI	10	200	48*28*21	8
		PR013430P	3/4" FPT*MPT 30PSI	10	200	48*28*21	8
		PR013430H	3/4" FHT*MHT 30PSI	10	200	48*28*21	8
		PR013445P	3/4" FPT*MPT 45PSI	10	200	48*28*21	8
		PR013445H	3/4" FHT*MHT 45PSI	10	200	48*28*21	8

技术参数 Technical Data:

货号 Item No.	规格 Model	进水压力 Inlet Pressure (PSI)	出水压力 Outlet Pressure (PSI)	流量范围 Flow Range (GPM)
PR013415P/H	15PSI	20-80	13-15	0.2-6.5
PR013420P/H	20PSI	25-80	18-20	0.2-6.5
PR013425P/H	25PSI	30-100	24-25	0.2-6.5
PR013430P/H	30PSI	35-100	29-30	0.2-6.5
PR013445P/H	45PSI	50-100	44-45	0.2-6.5

真空排气阀 Air & Vacuum Relief Valve

特点 Advantage:

- 进排气空气阀，适用于各种灌溉系统应用，系统注水时，空气阀排出管道中大量空气；系统排空时，空气阀吸入大量空气防止真空负压。
- 阀门采用先进的复合气体动力学设计，具有快速进排气；可避免空气积聚，防止形成负压，低压时具有良好的密封性能。
- Air valve is applied for irrigation system or networks of water supply. It evacuates air during pipeline filling and enables large volume air intake in the event of network draining.
- With its advanced aerodynamic design and kinetic orifice, this valve can provide excellent protection against vacuum formation, with improved sealing under low pressure conditions.

应用范围 Application:

- 灌溉系统管网：排出灌溉系统中的空气，避免水泵下游、沿程输水管道以及管道上下坡位置形成负压。
- 灌溉首部：排出空气，防止过滤器、施肥罐处形成负压。
- 灌溉管道高处：排出空气，避免系统高处空气聚集破坏管道。
- Main Irrigation Networks - Air relief and vacuum prevention downstream of pumps, along supply lines and at elevations in main irrigation networks.
- Irrigation Control Heads - Air relief and vacuum prevention at filtration and fertilization stations.
- High part of Irrigation Pipeline System - Air relief, Prevention of pipe broken as for high pressure air.

产品名称 Product Description	图片 Picture	货号 Item No.	规格 Size	每袋数量 Qty/Bag (Pc)	每箱数量 Qty/Ctn (Pc)	纸箱规格 Ctn Size (Cm)	毛重 G.W (Kg)
真空排气阀 Air & Vacuum Relief Valve		AV0112B	1/2"BSP	100	1200	42*28*21	7
真空排气阀 Air & Vacuum Relief Valve		AV0134B	3/4"BSP	10	200	54*35*28	16
		AV0134N	3/4"NPT	10	200	54*35*28	16
		AV0110B	1"BSP	10	180	54*35*28	18
		AV0110N	1"NPT	10	180	54*35*28	18
双向连续型真空 排气阀 Dual Acting Continuous Air & Vacuum Relief Valve		AV0210B	1"BSP	1	56	54*35*28	15
		AV0210N	1" NPT	1	56	54*35*28	15
		AV0232B	1-1/2"BSP	1	56	54*35*28	15
		AV0232N	1-1/2"NPT	1	56	54*35*28	15
双向连续型真空 排气阀 Dual Acting Continuous Air & Vacuum Relief Valve		AV0150B	2"BSP	1	15	54*35*28	12
		AV0150N	2"NPT	1	15	54*35*28	12

产品特性和优点 Advantage:

- 结构简单，性能可靠。
- 阀体采用直流道设计，进排气口尺寸大，流量大。
- 密封浮球移动行程长 - 防止浮球被高速气流吹起导致排气口过早关闭，并且不影响空气吸入或排除。
- 动力低压密封 - 可在低压下 (0.2bar) 保持良好密封性，避免发生漏水现象。
- 所有部件均具有抗腐蚀能力，维护频率低，使用寿命长。
- 系统注水过程中，大量空气快速从进排气口排出；水进入空气阀腔室后，浮球随液位上升关闭快速进排气口。符合气体动力学的阀体设计和浮球防吹起设计，可在水进入空气阀前防止浮球被高速气流吹起导致排气口过早关闭。
- 系统排空时形成负压差，空气向下推动浮球。动力式快速进排气口打开，空气进入空气阀，避免系统内形成负压。
- 系统有压状态下，进排气阀保持关闭。
- Compact, simple and reliable structure.
- Straight flow body with large diameter orifice – High flow rates.
- Aerodynamic full-body kinetic shield – Prevents premature closing without disturbing air intake or discharge.
- Dynamic sealing – Prevents leakage during operation even under low pressure conditions (0.2 bar).
- All parts are fully corrosion, chemical and fertilizer resistant – Lower maintenance and increased life span.
- Pipeline Filling: During the filling process of a pipeline, high air flow is forced out through the kinetic orifice of the air valve. Once water enters the valve's chamber, the float buoyed upwards causes the kinetic orifice to close. The unique aerodynamic structure of the valve body and float ensures that the float cannot be closed before water reaches the valve.
- Pipeline Draining: When a pipeline is drained, a negative differential pressure is created causing atmospheric air to push the float down.
- Pressurized Operation: During pressurized operation the kinetic orifice remains closed.

技术参数 Technical Data:

货号 Item No.	规格 Model	类型 Valve Type	最大工作压力 MAX Working Pressure (Psi)	封水压力 Sealing Pressure (psi)	排气量 Air Outtake Flow (m ³ /h)	真空吸入量 Air Intake Flow (m ³ /h)
AV0112B	1/2"BSP	排气阀 Air Relief Valve	150	6	0-35m ³ /h@0-6psi	-80-0m ³ /h @-6-0psi
AV0134B/N	3/4"BSP/NPT	真空排气阀 Air & Vacuum Relief Valve	150	5	0-50m ³ /h@0-5psi	-67-0m ³ /h @-6-0psi
AV0110B/N	1"BSP/NPT	真空排气阀 Air & Vacuum Relief Valve	150	5	0-50m ³ /h@0-5psi	-67-0m ³ /h @-6-0psi
AV0210B/N	1"BSP/NPT	真空排气阀 Air&Vacuum Relief Valve	150	5	0-280m ³ /h@0-5psi	-280-0 m ³ /h @-6-0psi
AV0232B/N	1-1/2"BSP/ NPT	真空排气阀 Air&Vacuum Relief Valve	225	5	0-330m ³ /h@0-5psi	-330-0 m ³ /h @-6-0psi
AV0150B/N	2"BSP/NPT	双向连续型真空排气阀 Dual Acting Continuous	225	5	0-235m ³ /h@0-5psi	-360-0m ³ /h @-6-0psi

1/2" 排气阀技术参数 1/2" Air Valve Technical Data

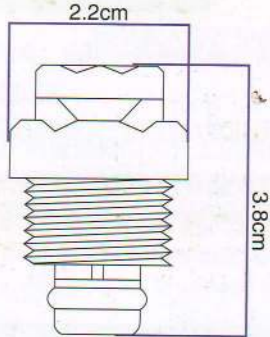

AV0112

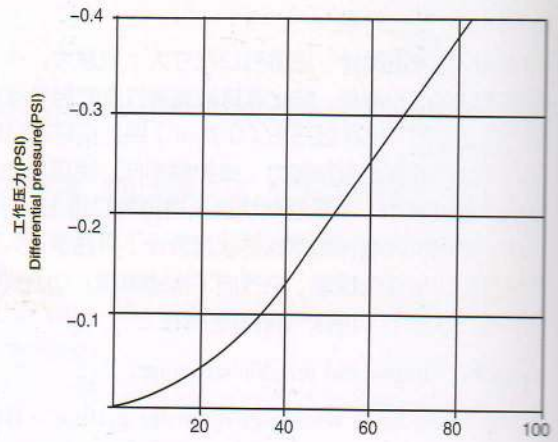

空气流量(m³/h) Air Flowing(m³/h)

1-1/2" 排气阀技术参数 1-1/2" Air Valve Technical Data



AV0210/AV0232

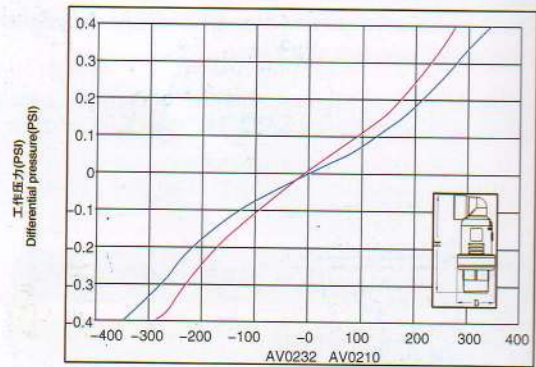

空气流量(m³/h) Air Flowing(m³/h)

2" 排气阀技术参数 2" Air Valve Technical Data

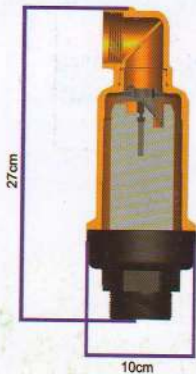

AV0150

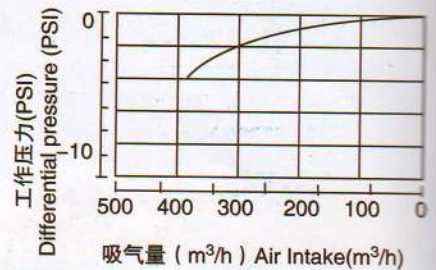
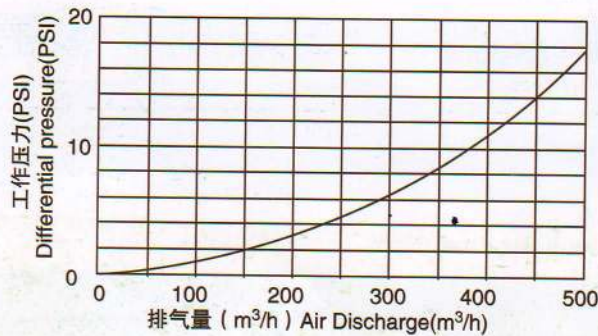

单位换算表 Conversion Table

压力 Pressure

从 From	到 To	倍数 Multiply by
kpa	psi	0.145
kpa	bar	0.01
kg/cm ²	psi	14.22
kg/cm ²	atm	0.968
bar	psi	14.5
bar	atm	0.987
atm	psi	14.692
atm	bar	1.013
psi	kg/cm ²	0.07
psi	kpa	6.89

体积 Volume

从 From	到 To	倍数 Multiply by
m ³	gal(USA)	264.172
m ³	gal(UK)	219.969
m ³	ft ³	35.315
cm ³	in ³	0.06
ft ³	m ³	0.028
in ³	cm ³	16.387
L	pinta(US)	2.113
L	gal(USA)	0.264
L	gal(UK)	0.22
gal(USA)	m ³	0.004

流量 Flow

从 From	到 To	倍数 Multiply by
m ³ /h	gpm(UK)	4.546
m ³ /h	gpm(USA)	3.785
m ³ /h	L/S	0.278
gpm(USA)	L/S	0.073
gpm(USA)	m ³ /h	0.264
gpm(UK)	L/S	0.061
gpm(UK)	m ³ /h	0.220
L/S	gpm(USA)	13.615
L/S	gpm(UK)	16.353

长度 Length

从 From	到 To	倍数 Multiply by
km	mi	0.621
m	ft	3.281
cm	in	0.0394
mm	in	0.394
mi	km	1.609
ft	m	0.305
in	Cm	2.54

灌溉用水量

$$W_{\text{日}} = 0.667 \times \frac{AE_p}{\eta}$$

$W_{\text{日}}$ —— 某块面积上日毛用水量 (m^3/d)

A —— 面积 (亩)

η —— 灌溉水利用系数

E_p —— 作物日需水量 (mm/d)

灌水定额

$$m = 0.1rH(\beta_1 - \beta_2)$$

m —— 设计灌水定额 (mm)

H —— 计划湿润层深度 (cm)

β_1, β_2 —— 适宜土壤含水量上下限 (重量百分比)

r —— 土壤干容重 (g/cm^3)

灌水周期

$$T = \frac{m}{E_p}$$

设计流量

$$Q_j = \frac{m \cdot A}{t \cdot T \cdot \eta} = \frac{E_p \cdot A}{t \cdot \eta}$$

$$Q_m = \frac{Q_j}{\eta_c}$$

Q_j, Q_m —— 系统设计净流量和毛流量 (m^3/h)

m —— 设计灌水定额 ($\text{m}^3/\text{亩}$)

A —— 灌溉面积 (亩)

T —— 设计灌水周期 (d)

t —— 每日净灌溉时间 (h)

η —— 田间水利用系数

η_c —— 输水系统水的利用系数

管嘴和小孔出流计算

$$Q = \mu A \sqrt{2gH_0}$$

Q 为流量, 单位 m^3/s

μ 为流量系数, 对于管嘴一般为 0.95, 对于孔口一般为 0.60~0.65

H_0 为出口前稳定段的总水头, 或者管道中的压力水头, 单位 m

A 断面面积, m^2

系统扬程计算

$$H = \Delta z + h_w + h_p$$

H —— 系统设计扬程

Δz —— 典型灌水器至水源水面的高度 (m)

h_w —— 水头损失

h_p —— 典型出水点灌水器的工作压力水头 (m)

沿程水头损失计算

$$h_f = f \frac{LQ^m}{d^b}$$

Q —— 管道中流量

L —— 计算管长 (m)

d —— 管道内径 (mm)

f —— 摩擦损失系数

m —— 流量指数

b —— 管径指数

规模不大的干管管径估算

当 $Q < 120 \text{m}^3/\text{h}$ 时, $D = 13\sqrt{Q}$

当 $Q \geq 120 \text{m}^3/\text{h}$ 时, $D = 11.5\sqrt{Q}$

D 是管径 (mm), Q 是每小时流量

微灌设计耗水强度

$$E_a = k_r E_c$$

$$k_r = \frac{G_c}{0.85}$$

E_a —— 微灌作为耗水强度, mm/d

k_r —— 作物的遮荫率对耗水量的修正系数, 当由计算出的数值大于 1 时, 取 $k_r = 1$

G_c —— 作物的遮荫率

E_c —— 作物需水量, mm/d

微灌灌水均匀度

$$q_v = \frac{q_{\max} - q_{\min}}{q_a}$$

q_{\max} —— 流量偏差

q_{\min} —— 灌水单元中灌水器最大流量, L/h

q_v —— 灌水单元中灌水器最小流量, L/h

q_a —— 灌水单元中灌水器平均流量或设计流量, L/h

水泵需配套功率估算

$$W = \frac{QH}{200}$$

W —— 需配备的动力大小, Kw

Q —— 设计流量, m^3/h

H —— 水泵扬程, m