















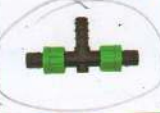

拉扣式带用配件 Lock Ring Fitting for Drip Tape

| 产品名称 Product Description | 图片 Picture | 货号 Item No. | 规格 Size | 每袋数量 Qty/Bag (Pc) | 每箱数量 Qty/Ctn (Pc) | 纸箱规格 Ctn Size (Cm) | 毛重 G.W (Kg) |
|---|---|----------------|------------|-------------------------|-------------------------|--------------------------|-------------------|
| 拉扣带用旁通接头 Lock Ring Offtake for Drip Tape |  | TO011312 | Dn13*12 | 100 | 3500 | 54*35*28 | 14 |
| | | TO021712 | Dn17*12 | 100 | 2000 | 54*35*28 | 12 |
| PVC 管用拉扣旁通 (带单层胶圈) PVC Offtake for Drip Tape |  | TO011312R | Dn13 | 100 | 3300 | 54*35*28 | 15 |
| | | TO021712R | Dn17 | 100 | 1800 | 54*35*28 | 14 |
| 拉扣带用直接 Lock Ring Coupling for Drip Tape |  | LC0213 | Dn13 | 100 | 3000 | 54*35*28 | 16 |
| | | LC0217 | Dn17 | 100 | 1400 | 54*35*28 | 12 |
| 拉扣带用承插接头 Barb Lock Ring Coupling for Drip Tape |  | BC021617 | Dn17*16 | 100 | 1600 | 54*35*28 | 11 |
| 外螺纹拉扣带用接头 Male Thread Lock Ring Coupling for Drip Tape |  | MT021712 | Dn17*16 | 100 | 1600 | 54*35*28 | 12 |
| 带用拉扣弯头 Lock Ring Elbow for Drip Tape |  | ET0217 | Dn17 | 100 | 1200 | 54*35*28 | 12 |
| 拉扣带用三通 Lock Ring Tee for Drip Tape |  | TT0317 | Dn17 | 50 | 700 | 54*35*28 | 14 |
| 拉扣带用旁通三通 Offtake Lock Ring Tee for Drip Tape |  | BT041712 | Dn17*12*17 | 50 | 800 | 54*35*28 | 14 |
| PVC 管用拉扣带用 旁通三通 PVC Offtake Lock Ring Tee for Drip Tape |  | BT041712R | Dn17*12*17 | 50 | 700 | 54*35*28 | 14 |
| 拉扣带用接头 Lock Ring Tape Plug |  | TP0317 | Dn17 | 100 | 2000 | 54*35*28 | 11 |

锁扣式带用配件 Lock Nut Fitting for Drip Tape

| 产品名称 Product Description | 图片 Picture | 货号 Item No. | 规格 Size | 每袋数量 Qty/Bag (Pc) | 每箱数量 Qty/Ctn (Pc) | 纸箱规格 Ctn Size (Cm) | 毛重 G.W (Kg) |
|--|---|----------------|------------|-------------------------|-------------------------|--------------------------|-------------------|
| 带用旁通接头 Tape Offtake |  | TO011706 | Dn17*6 | 100 | 1500 | 54*35*28 | 17 |
| | | TO011712 | Dn17*12 | 100 | 1300 | 54*35*28 | 15 |
| 带用锁扣旁通 Lock Type Offtake |  | LO0117 | Dn17 | 100 | 1000 | 54*35*28 | 13 |
| 带用旁通 (带单层胶圈) PVC Offtake for Tape |  | PO0117R | Dn17 | 100 | 1100 | 54*35*28 | 15 |
| 带用锁扣直接 Lock Coupling for Tape |  | LC0117 | Dn17 | 100 | 800 | 54*35*28 | 14 |
| | | LC0122 | Dn22 | 100 | 500 | 54*35*28 | 17 |
| 带用承插接头 Barbed Coupling for Tape |  | BC011617 | Dn17*16 | 100 | 1100 | 54*35*28 | 14 |
| | | BC012022 | Dn22*20 | 100 | 600 | 54*35*28 | 12 |
| 外螺纹带用接头 Male Thread Coupling for Tape |  | MT011712 | Dn17*1/2" | 100 | 1000 | 54*35*28 | 14 |
| | | MT011734 | Dn17*3/4" | 100 | 1000 | 54*35*28 | 15 |
| 带用涂塑软管旁通 接头 Connection for Lay Flat Hose |  | CT0117 | Dn17 | 100 | 900 | 54*35*28 | 17 |
| 可折式带用涂塑软管 旁通接头 Connection for Lay Flat Hose |  | CT0217 | Dn17 | 100 | 550 | 54*35*28 | 16 |
| 涂塑软管快速带用 接头 Croco Offtake for Lay Flat Hose |  | CT0317 | Dn17 | 100 | 700 | 54*35*28 | 19 |

| 产品名称 Product Description | 图片 Picture | 货号 Item No. | 规格 Size | 每袋数量 Qty/Bag (Pc) | 每箱数量 Qty/Ctn (Pc) | 纸箱规格 Ctn Size (Cm) | 毛重 G.W (Kg) |
|---|---|----------------|------------|-------------------------|-------------------------|--------------------------|-------------------|
| 带用锁扣弯头 Lock Elbow for Tape |  | ET0117 | Dn17 | 100 | 700 | 54*35*28 | 14 |
| 单边承插式带用三通 One Barb Tape Tee |  | BT011716 | Dn17*16*17 | 50 | 500 | 54*35*28 | 12 |
| 单头锁扣三通 Tape Tee with Two Barb |  | BT021716 | Dn17*16 | 50 | 800 | 54*35*28 | 12 |
| PVC 管用旁通带用三通 Offtake Tee for Tape with Rubber Ring |  | BT031708R | Dn17*10 | 50 | 400 | 54*35*28 | 12 |
| 三边锁扣带用三通 Lock Tee for Tape |  | TT0117 | Dn17 | 50 | 300 | 54*35*28 | 10 |
| 外螺纹带用三通 Male Threaded Tape Tee |  | TT021712 | Dn17*1/2" | 50 | 450 | 54*35*28 | 12 |
| 可折式带用涂塑软管三通接头 Tape Tee for Lay Flat Hose |  | TT0417 | Dn17 | 50 | 300 | 54*35*28 | 13 |
| 锁扣式带用堵头 Tape Plug |  | TP0117 | Dn17 | 100 | 2000 | 54*35*28 | 18 |
| 折叠式带用堵头 Tape Sleeve End |  | TP0217 | Dn17 | 100 | 2400 | 54*35*28 | 20 |



滴灌带用阀门 Mini Valve for Drip Tape

| 产品名称 Product Description | 图片 Picture | 货号 Item No. | 规格 Size | 每袋数量 Qty/Bag (Pc) | 每箱数量 Qty/Ctn (Pc) | 纸箱规格 Ctn Size (Cm) | 毛重 G.W (Kg) |
|---|---|----------------|------------|-------------------------|-------------------------|--------------------------|-------------------|
| 多功能 带用管用阀门 Multi Valve for Drip Tape and Pipe |  | MV021617 | Dn16*17 | 50 | 450 | 54*35*28 | 17 |
| 多功能带用管用阀门 (带双层胶圈) Multi Valve for Drip Tape and Pipe (With H Grommet) |  | MV021617R | Dn16*17 | 50 | 400 | 54*35*28 | 17 |
| 承插带用阀门 Barb-Lock Vale for Tape |  | BV011617 | Dn16*17 | 50 | 450 | 54*35*28 | 16 |
| 带用锁扣旁通阀门 Offtake Valve for Tape |  | OV0217 | Dn17 | 50 | 450 | 54*35*28 | 16 |
| 带用旁通阀门 Offtake Tape Valve |  | OV031708 | Dn17*8 | 50 | 450 | 54*35*28 | 16 |
| 带用旁通阀门 (带单层胶圈) Offtake Tape Valve with T Grommet |  | OV031708R | Dn17*8 | 50 | 400 | 54*35*28 | 17 |
| 外螺纹带用阀门 Male Thread Valve for Tape |  | TV0117 | Dn17*1/2" | 50 | 400 | 54*35*28 | 16 |
| 双边带用锁扣阀门 Lock Tape Coupler with Valve |  | LV0117 | Dn17 | 50 | 450 | 54*35*28 | 17 |
| 涂塑软管 旁通带用阀门 Tape Valve for Lay Flat Hose |  | TV0217 | Dn17 | 50 | 300 | 54*35*28 | 16 |

滴箭及其配件 Arrow Dripper and Accessory

滴箭

- 滴箭与 Dn5/3 PVC 软管相连接, 可同时有多个滴箭并连, 一般有一出一、一出二和一出四, 三种规格。
- 特别适用于盆栽作物的灌溉或定向作物灌溉。

Arrow Dipper

- Arrow Dripper is connected with Dn5/3mm soft PVC pipe and adapter, also can be connected with Multi-outlet assemblies to get several outlet in same time.
- Fit for watering the plants in pots.

| 产品名称 Product Description | 图片 Picture | 货号 Item No. | 规格 Size | 每袋数量 Qty/Bag (Pc) | 每箱数量 Qty/Ctn (Pc) | 纸箱规格 Ctn Size (Cm) | 毛重 G.W (Kg) |
|--|---|----------------|---------------|-------------------------|-------------------------|--------------------------|-------------------|
| 直滴箭 Straight Arrow Dripper |  | 2101 | 1.8L/h | 100 | 5000 | 54*35*28 | 13 |
| 弯滴箭 Bend Arrow Dripper |  | 2102 | 2.2L/h | 100 | 4500 | 54*35*28 | 10 |
| 长弯滴箭 Long Bend Arrow |  | 2152 | 2.2L/h | 100 | 2800 | 54*35*28 | 10 |
| 一出直滴箭 One Branch Straight Arrow Dripper |  | 2111 | 50cm*1 | 10 | 1800 | 66*31*40 | 18 |
| 一出弯滴箭 One Branch Bend Arrow Dripper |  | 2112 | 50cm*1 | 10 | 1500 | 66*31*40 | 16 |
| 二出直滴箭 Two Branches Straight Arrow Dripper |  | 2121 | 50cm*2 | 10 | 750 | 66*31*40 | 18 |
| 二出弯滴箭 Two Branches Bend Arrow Dripper |  | 2122 | 50cm*2 | 10 | 700 | 66*31*40 | 17 |
| 四出直滴箭 Four Branches Straight Arrow Dripper |  | 2141A | 50cm*4 Dn3 | 10 | 350 | 66*31*40 | 17 |
| | | 2141B | 50cm*4 Dn4 | 10 | 350 | 66*31*40 | 17 |
| 四出弯滴箭 Four Branches Bend Arrow Dripper |  | 2142A | 50cm*4 Dn3 | 10 | 300 | 66*31*40 | 13 |
| | | 2142B | 50cm*4 Dn4 | 10 | 300 | 66*31*40 | 13 |
| 一出长弯滴箭 One Branches Long Arrow Dripper |  | 21521 | 50cm*1 | 10 | 1100 | 66*31*40 | 13 |
| 二出长弯滴箭 Two Branches Long Arrow Dripper |  | 21522 | 50cm*2 | 10 | 400 | 66*31*40 | 10 |
| 四出长弯滴箭 Four Branches Long Arrow Dripper |  | 21524A | 50cm*4 Dn3 | 10 | 200 | 66*31*40 | 10 |
| | | 21524B | 50cm*4 Dn4 | 10 | 200 | 66*31*40 | 10 |

滴箭配件 Accessory for Arrow Dripper

| 产品名称 Product Description | 图片 Picture | 货号 Item No. | 规格 Size | 每袋数量 Qty/Bag (Pc) | 每箱数量 Qty/Ctn (Pc) | 纸箱规格 Ctn Size (Cm) | 毛重 G.W (Kg) |
|--|---|----------------|------------|-------------------------|-------------------------|--------------------------|-------------------|
| PVC 软管 PVC Soft Pipe |  | PV010453 | Dn5/3 | 500m/roll | 3rolls/bag | Dn45*60 | 30 |
| 单倒刺接头 Adaptor for Micro Tube |  | 5131 | Dn5 | 500 | 25000 | 42*28*21 | 9 |
| 双倒刺接头 Two Branches for Micro Tube |  | 5132 | Dn5 | 500 | 25000 | 42*28*21 | 9 |
| 双倒刺三通 Two Branches for Micro Tube |  | 5133 | Dn5 | 500 | 13000 | 42*28*21 | 9 |
| 四倒刺五通 Five Branches for Micro Tube |  | 5135A | Dn5*5 | 500 | 6000 | 42*28*21 | 7 |
| 四倒刺五通 Five Branches for Micro Tube |  | 5135B | Dn6*5 | 500 | 6000 | 42*28*21 | 7 |

技术参数 Technical Data:

| 货号 Item No. | 工作压力 VS 流量 Working Preaature (Bar) VS Discharge(L/h) CV ≤ 5% | | | | | | | | | | 流态指数 Flow Index |
|----------------|---|--------|--------|--------|--------|--------|--------|--------|--------|--------|--------------------|
| | 0.2Bar | 0.4Bar | 0.6Bar | 0.8Bar | 1.0Bar | 1.2Bar | 1.4Bar | 1.6Bar | 1.8Bar | 2.0Bar | |
| 2101 | 0.6 | 1.1 | 1.4 | 1.6 | 1.8 | 2.0 | 2.3 | 2.4 | 2.5 | 2.6 | $Q=1.8H^{0.619}$ |
| 2102 | 0.9 | 1.5 | 1.7 | 2.0 | 2.2 | 2.4 | 2.7 | 2.9 | 3.2 | 3.4 | $Q=2.2H^{0.548}$ |
| 2152 | 0.9 | 1.4 | 1.7 | 2.0 | 2.2 | 2.4 | 2.6 | 2.7 | 2.9 | 3.1 | $Q=2.2H^{0.516}$ |



管上式滴头 On-Line Dripper

特点:

- 采用优质工程塑料生产,耐化学腐蚀、抗紫外线、抗老化。
- 独特宽流道或紊流道设计,抗堵塞能力强。
- 其中可拆洗滴头方便拆装易于清洗。
- 流量可调式滴头,调整流量范围广,可适用地形起伏不定的灌溉区域,通过调整不同落差位置每个滴头的流量,达到整个灌溉区域每个滴头出水量均匀的效果。
- 紊流式管上滴头,具有一定的压力补偿效果,同时工作压力范围广,可适用地形起伏较大的灌溉区域,当地形落差较大,超过常规压力补偿滴头的工作压力范围时,可代替其使用。
- 采购成本和安装维护费用相对较低,便于广泛使用。
- 在低压力情况下,流量稳定性好,推荐使用压力范围为 1-1.5bar。
- 可以与 Dn6mm 软管联接或打孔直接安装在 Dn12-32PE 软管上,易于安装维护。
- 可广泛使用于落木丛、果园和其他作物的灌溉。

Advantage:

- Stable and high quality material resistant to agricultural chemicals and UV degradation.
- Highly clog-resistant due to wide, deep turbulent passageways.
- Easy to remove for inspection and cleaning.
- Low cost of these dripper makes them very popular.
- The discharges are rated from 1 bar to 1.5bar, and at lower pressure you will get a lower discharge and at higher pressure you will get a somewhat higher discharge.
- At very low pressure, these drippers work better than pressure compensating dripper.
- Easy installation, connect them with Dn6mm hose or insert them onto Dn12-32 PE hose directly for various requirement of irrigation.

Application:

- Ideal for those installations where quality of the water may represent a problem, you can be easy to clean the emitter if you use Take apart dripper
- Ideal for those installations where the terrain of land is excessive to be sure them work well although the differential head is large.
- Suitable for most horticultural trees, row crops, and vineyards.

| 产品名称 Product Description | 图片 Picture | 货号 Item No. | 规格 Size | 每袋数量 Qty/Bag (Pc) | 每箱数量 Qty/Ctn (Pc) | 纸箱规格 Ctn Size (Cm) | 毛重 G.W (Kg) |
|---|---|----------------|-------------------------------------|-------------------------|-------------------------|--------------------------|-------------------|
| 可拆洗式滴头 Take Apart Dripper |  | TAD0104 | 4L/h | 100 | 11000 | 54*35*28 | 18 |
| | | TAD0108 | 8L/h | 100 | 11000 | 54*35*28 | 18 |
| | | TAD0116 | 16L/h | 100 | 11000 | 54*35*28 | 18 |
| 可调式管上式滴头 Adjustable On-line |  | AOD0170 | 1/4" 0-70L/h@1Bar 15cm Length | 100 | 8800 | 54*35*28 | 15 |
| 可调式地插滴头 Adjustable Sprayer |  | AOD0170H | 1/4" 0-70L/h@1Bar 15cm Length | 100 | 1500 | 54*35*28 | 8 |
| 紊流式管上滴头 Turbulent Flowing On-line Dripper |  | TOD0102 | 2L/h | 100 | 3600 | 54*35*28 | 16 |
| | | TOD0104 | 4L/h | 100 | 3600 | 54*35*28 | 16 |
| | | TOD0108 | 8L/h | 100 | 3600 | 54*35*28 | 16 |
| | | TOD0116 | 16L/h | 100 | 3600 | 54*35*28 | 16 |

技术参数 Technical Data:

| 货号 Item No. | 工作压力 VS 流量 Working Preaaure (Bar) VS Discharge(L/h) | | | | | | |
|----------------|--|--------|--------|--------|--------|--------|--------|
| | 0.7Bar | 1.0Bar | 1.5Bar | 2.0Bar | 2.5Bar | 3.0Bar | 3.5Bar |
| TAD0104 | 3.4 | 3.8 | 4.2 | 4.5 | 4.7 | 5.1 | 5.5 |
| TAD0108 | 7.1 | 8.1 | 8.5 | 9.1 | 9.4 | 10.2 | 11.3 |
| TAD0116 | 14.7 | 16.3 | 17.1 | 17.9 | 18.6 | 19.7 | 21.6 |
| TOD0102 | 1.5 | 2.0 | 2.6 | 3.1 | 3.6 | 4.1 | 4.4 |
| TOD0104 | 3.5 | 4.1 | 5.0 | 5.8 | 6.5 | 7.2 | 7.8 |
| TOD0108 | 6.7 | 7.9 | 9.7 | 11.5 | 13.0 | 14.4 | 15.8 |
| TOD0116 | 14.2 | 16.1 | 20.9 | 25.1 | 29.2 | 32.8 | 36.2 |

* 备注: 以上滴头使用 6mm 毛管连接, 用 3mm 打孔器。

* Note: All above dripper with 6mm Barb Adaptor, for installation use Dn3mm Punch

| AOD0170 标准 | | | | | | |
|-------------|--|--------|--------|--------|--------|--------|
| 齿数 Click | 工作压力 VS 流量 Working Preaaure (Bar) VS Discharge(L/h) | | | | | |
| | 0.5Bar | 1.0Bar | 1.5Bar | 2.0Bar | 2.5Bar | 3.0Bar |
| 2 | 12.0 | 17.6 | 27.3 | 30.6 | 35.1 | 39.0 |
| 4 | 16.1 | 25.3 | 31.5 | 38.0 | 43.7 | 48.8 |
| 8 | 23.0 | 36.3 | 44.4 | 52.5 | 59.7 | 68.2 |
| 12 | 29.6 | 46.2 | 55.2 | 65.0 | 72.3 | 79.9 |
| 16 | 33.1 | 48.1 | 61.9 | 73.0 | 81.5 | 89.0 |
| 20 | 35.7 | 55.3 | 70.5 | 81.3 | 94.2 | 102.2 |
| 24 | 41.0 | 65.1 | 80.3 | 92.6 | 106.1 | 115.6 |
| 30 | 51.2 | 76.2 | 98.7 | 114.0 | 127.1 | 140.8 |
| 32 | 52.7 | 80.0 | 98.7 | 115.1 | 130.5 | 143.0 |

* 备注: 16 齿 = 1 圈 32 齿 = 2 圈, 最大可调为 2 圈

最小射程半径: 5cm@1Bar 最大射程半径: 40cm@1Bar

流量小于 12L/H 时滴水, 大于 12L/H 伞状出水

* Note: 16click=1Turn 32click=2Turn Max Adjusting 2Turn

Minimum Spray Radius 5cm@1bar, Maximum Spray Radius 40cm@1bar

Drip out when the flowing is less than 12L/h, Spary out when the flowing is more than 12L/h



压力补偿滴头 Dripper with PC

特点:

- 在因距离差或地面不平整而产生不同压力情况下, 压力补偿滴头可提供稳定的滴水量。
- 可拆式压力补偿滴头可以方便打开外壳, 易于清洗。
- 自清洗式压力补偿滴头采用宽流道设计, 抗堵塞能力强。
- 防倒吸式压力补偿滴头采用紊流道设计, 当压力低于 0.15bar 时自动关闭出水口, 当压力达到 0.4bar 滴头才出水, 防止系统开关过程中产生倒吸堵塞出水口, 同时也避免在系统关闭后出现滴漏水现象。
- 可以与 Dn6mm 软管联接或打孔直接安装在 Dn12-32PE 软管上, 易于安装维护, 可降低施工和维护成本

Advantage:

- PC dripper deliver a precise amount of water regardless of changes in pressure due to long rows or change in terrain.
- Take Apart PC dripper with removable cap for easy cleaning.
- Compact PC dripper with wide and deep passageways for highly clog-resistant .
- Compact PC dripper with wide and deep passageways for highly clog-resistant .
- No-drain PC dripper with turbulent passageways, can be self-flushing with opening pressure at 0.4bar and shutting off pressure at 0.15bar which prevents drainage from system and also allow system start and shut off quickly without leakage .
- Simplify the design of a system and greatly reduce the cost of installation and maintenance.
- Easy installation, connect them with Dn6mm hose or insert them onto Dn12-32 PE hose directly for various requirement of irrigation.

| 产品名称 Product Description | 图片 Picture | 货号 Item No. | 规格 Size | 每袋数量 Qty/Bag (Pc) | 每箱数量 Qty/Ctn (Pc) | 纸箱规格 Ctn Size (Cm) | 毛重 G.W (Kg) |
|--|---|----------------|------------|----------------------|----------------------|-----------------------|----------------|
| 可拆式压力补偿滴头 Take Apart PC Dripper |  | PCT0102 | 2L/h | 100 | 4500 | 54*35*28 | 17 |
| | | PCT0104 | 4L/h | 100 | 4500 | 54*35*28 | 17 |
| | | PCT0108 | 8L/h | 100 | 4500 | 54*35*28 | 17 |
| 管上式自清洗压力补偿滴头 Compact On-line PC Dripper |  | PCT0304 | 4L/h | 100 | 16000 | 54*35*28 | 17 |
| | | PCT0308 | 8L/h | 100 | 16000 | 54*35*28 | 17 |
| | | PCT0312 | 12L/h | 100 | 16000 | 54*35*28 | 17 |
| 防倒吸式压力补偿滴头 No-Drain PC Dripper |  | DPE0102 | 2L/h | 100 | 7000 | 54*35*28 | 20 |
| | | DPE0104 | 4L/h | 100 | 7000 | 54*35*28 | 20 |
| | | DPE0108 | 8L/h | 100 | 7000 | 54*35*28 | 20 |

技术参数 Technical Data:

| 货号 Item No. | 工作压力 VS 流量 Working Preaature (Bar) VS Discharge(L/h) | | | | | | | | |
|----------------|---|--------|--------|--------|--------|--------|--------|--------|--------|
| | 0.5Bar | 0.7Bar | 1.0Bar | 1.5Bar | 2.0Bar | 2.5Bar | 3.0Bar | 3.5Bar | 4.0Bar |
| PCT0102 | 1.9 | 2.0 | 2.1 | 2.0 | 2.2 | 2.1 | 2.2 | 2.2 | 2.1 |
| PCT0104 | 3.7 | 3.9 | 4.1 | 4.2 | 4.2 | 4.3 | 4.4 | 4.2 | 4.1 |
| PCT0108 | 7.8 | 7.9 | 8.0 | 8.2 | 8.1 | 8.4 | 8.3 | 8.1 | 7.9 |
| PCT0304 | 3.8 | 3.9 | 4.0 | 4.1 | 4.1 | 4.1 | 4.0 | 3.9 | 4 |
| PCT0308 | 7.9 | 7.9 | 8.1 | 8.2 | 8.1 | 8.0 | 8.0 | 7.9 | 7.8 |
| PCT0312 | 11.5 | 11.5 | 11.7 | 11.9 | 12.1 | 12.2 | 12.0 | 11.8 | 11.7 |
| DPE0102 | 1.8 | 1.8 | 2.1 | 2.2 | 2.3 | 2.4 | 2.1 | 1.7 | 1.7 |
| DPE0104 | 3.6 | 3.6 | 4.1 | 4.2 | 4.4 | 4.2 | 3.8 | 3.4 | 3.4 |
| DPE0108 | 7.6 | 7.6 | 7.9 | 8.5 | 8.8 | 8.7 | 7.8 | 7.5 | 7.5 |

* Note: All above dripper with 1/4" Barb Adaptor, for installation use Dn3mm Punch

旋转微喷头和折射喷头 Microsprinkler & Microjet

| 产品名称 Product Description | 图片 Picture | 货号 Item No. | 规格 Size | 每袋数量 Qty/Bag (Pc) | 每箱数量 Qty/Ctn (Pc) | 纸箱规格 Ctn Size (Cm) | 毛重 G.W (Kg) |
|---|---|-------------------|------------|-------------------------|-------------------------|--------------------------|-------------------|
| 倒挂式旋转微喷头 Microsprinkler, Upside Down Type |  | MS1101A - MS1104A | Dn7 | 100 | 3000 | 54*35*28 | 15 |
| 地插式旋转微喷头 Microsprinkler, Standing Type |  | MS1101B - MS1104B | Dn7 | 100 | 3000 | 54*35*28 | 15 |
| 防虫式旋转微喷头 Anti-Insect Microsprinkler |  | MS3002 - MS3008 | Dn7 | 100 | 4600 | 54*35*28 | 20 |

技术参数 Technical Data:

| 工作压力 Working Pressure | | 1.5Bar | | 2.0Bar | | 2.5Bar | | 3.0Bar | |
|-----------------------|----------------------|-----------------|----------------|-----------------|----------------|-----------------|----------------|-----------------|----------------|
| 货号 Item No. | 喷嘴颜色 Nozzle Color | 流量 Discharge | 直径 Diameter | 流量 Discharge | 直径 Diameter | 流量 Discharge | 直径 Diameter | 流量 Discharge | 直径 Diameter |
| MS1101A | Black | 24.6L/h | 6.4m | 28L/h | 7.0m | 31L/h | 7.0m | 34L/h | 7.2m |
| MS1102A | Blue | 39L/h | 7.8m | 44L/h | 8.0m | 49L/h | 8.2m | 54L/h | 8.4m |
| MS1103A | Green | 58.5L/h | 8.0m | 66.6L/h | 8.6m | 75L/h | 8.8m | 82.5L/h | 8.8m |
| MS1104A | Red | 73.5L/h | 2.8m | 82.8L/h | 8.6m | 93.9L/h | 8.8m | 103.5L/h | 9.0m |
| MS1101B | Black | 24.6L/h | 5.0m | 28L/h | 5.6m | 31L/h | 6.0m | 34L/h | 6.4m |
| MS1102B | Blue | 39L/h | 6.4m | 44L/h | 6.4m | 49L/h | 7.0m | 54L/h | 7.2m |
| MS1103B | Green | 58.5L/h | 6.8m | 66.8L/h | 7.0m | 75L/h | 7.4m | 82.5L/h | 7.8m |
| MS1104B | Red | 73.5L/h | 7.4m | 82.8L/h | 8.0m | 93.9L/h | 8.0m | 103.5L/h | 8.4m |
| MS3002 | Gray | 42.20L/h | 4.2m | 47.50L/h | 4.6m | 51.70L/h | 5.0m | 58.40L/h | 5.6m |
| MS3003 | Black | 59.00L/h | 4.6m | 68.60L/h | 5.0m | 76.20L/h | 5.4m | 83.20L/h | 6.0m |
| MS3004 | Green | 79.30L/h | 5.2m | 97.00L/h | 5.6m | 100.60L/h | 6.0m | 106.20L/h | 6.4m |
| MS3005 | Blue | 96.20L/h | 5.6m | 109.40L/h | 6.2m | 123.00L/h | 6.4m | 126.40L/h | 6.6m |
| MS3006 | Red | 128.00L/h | 6.2m | 144.80L/h | 3.3m | 155.80L/h | 7.0m | 179.00L/h | 7.2m |
| MS3007 | Yellow | 149.00L/h | 6.4m | 168.00L/h | 7.0m | 189.60L/h | 7.2m | 213.60L/h | 7.4m |
| MS3008 | Light Green | 193.00L/h | 7.0m | 218.00L/h | 7.4m | 245.00L/h | 7.4m | 277.60L/h | 7.6m |

旋转微喷头和折射喷头 Microsprinkler & Microjet

| 产品名称 Product Description | 图片 Picture | 货号 Item No. | 规格 Size | 每袋数量 Qty/Bag (Pc) | 每箱数量 Qty/Ctn (Pc) | 纸箱规格 Ctn Size (Cm) | 毛重 G.W (Kg) |
|--|---|------------------|------------|-------------------------|-------------------------|--------------------------|-------------------|
| 倒挂式 360 度全圆微喷头 360° No Bridge Mini Sprinklers, Upside Down Type |  | MS8050 - MS80120 | Dn7 | 100 | 4500 | 54*35*28 | 19 |
| 地插式 360 度全圆微喷头 360° No Bridge Mini Sprinklers, Standing Type |  | MS8150 - MS81120 | Dn7 | 100 | 4500 | 54*35*28 | 19 |

技术参数 Technical Data:

| 压力 V S 流量和射程 Pressure VS Flowing A Wetting Radius | | | | | | | | | | | | |
|---|-------------------------------|-----------------------------|-----------------|------------------------------|-----------------|------------------------------|-----------------|------------------------------|-----------------|------------------------------|-----------------|------------------------------|
| 工作压力 Working Pressure | | 1Bar | | 1.5Bar | | 2.0Bar | | 2.5Bar | | 3.0Bar | | |
| 货号 Item No. | 叶轮 颜色 Impeller Color | 喷嘴 颜色 Nozzle Color | 流量 Discharge | 射程直径 Standing Diameter | 流量 Discharge | 射程直径 Standing Diameter | 流量 Discharge | 射程直径 Standing Diameter | 流量 Discharge | 射程直径 Standing Diameter | 流量 Discharge | 射程直径 Standing Diameter |
| MS8050 | 蓝色 Blue | Green | 28L/h | 3.0m | 32L/h | 2.6m | 34L/h | 2.6m | 38L/h | 2.6m | 41L/h | 2.6m |
| MS8070 | | Blue | 40L/h | 2.6m | 49L/h | 2.8m | 49L/h | 3.0m | 54L/h | 3.2m | 60L/h | 3.2m |
| MS80100 | | Yellow | 53L/h | 2.6m | 63L/h | 2.8m | 63L/h | 3.6m | 71L/h | 4.4m | 77L/h | 4.8m |
| MS80120 | | Red | 65L/h | 4.0m | 80L/h | 5.0m | 78L/h | 5.0m | 86L/h | 5.0m | 95L/h | 5.0m |
| MS8150 | 绿色 Green | Green | 28L/h | 6.0m | 32L/h | 6.0m | 34L/h | 6.4m | 38L/h | 6.4m | 41L/h | 7.0m |
| MS8170 | | Blue | 40L/h | 6.0m | 49L/h | 6.4m | 49L/h | 6.4m | 54L/h | 6.4m | 60L/h | 6.6m |
| MS81100 | | Yellow | 53L/h | 6.4m | 63L/h | 6.4m | 63L/h | 6.4m | 71L/h | 6.4m | 77L/h | 7.0m |
| MS81120 | | Red | 65L/h | 6.0m | 80L/h | 6.4m | 78L/h | 6.4m | 86L/h | 7.0m | 95L/h | 7.0m |

备注：地插高地面垂直距离为 1 米，倒挂高地面垂直距离 1 米，无风条件下测试

旋转微喷头和折射喷头 Microsprinkler & Microjet

| 产品名称 Product Description | 图片 Picture | 货号 Item No. | 规格 Size | 每袋数量 Qty/Bag (Pc) | 每箱数量 Qty/Ctn (Pc) | 纸箱规格 Ctn Size (Cm) | 毛重 G.W (Kg) |
|------------------------------------|---|-------------------|------------|-------------------------|-------------------------|--------------------------|-------------------|
| 折射式雾化微喷头 Microjet |  | MJ1201- MJ1204 | Dn7 | 100 | 3600 | 54*35*28 | 16 |
| 防虫式全圆折射微喷头 Anti-Insect Microjet |  | MJ4002- MJ4007 | Dn7 | 100 | 4600 | 54*35*28 | 14 |

Technical Data:

| 货号 Item No. | 喷嘴颜色 Nozzle Color | 工作压力 Working Pressure | 1.5Bar | 2.0Bar | 2.5Bar | 3.0Bar |
|----------------|----------------------|--------------------------|-----------|---------|---------|----------|
| MJ1201 | Black | 流量 Discharge | 24.6L/h | 28L/h | 3.1L/h | 3.4L/h |
| | | 倒挂直径 Hanged Diameter | 2.0m-2.2m | | | |
| | | 地插直径 Standing Diameter | 1.8m-2.0m | | | |
| MJ1202 | Blue | 流量 Discharge | 39L/h | 44L/h | 49L/h | 54L/h |
| | | 倒挂直径 Hanged Diameter | 2.2m-2.4m | | | |
| | | 地插直径 Standing Diameter | 2.0m-2.2m | | | |
| MJ1203 | Green | 流量 Discharge | 58.5L/h | 66.6L/h | 75L/h | 82.5L/h |
| | | 倒挂直径 Hanged Diameter | 2.4m-2.6m | | | |
| | | 地插直径 Standing Diameter | 2.2m-2.4m | | | |
| MJ1204 | Red | 流量 Discharge | 73.5L/h | 82.8L/h | 93.9L/h | 103.5L/h |
| | | 倒挂直径 Hanged Diameter | 2.6m-2.8m | | | |
| | | 地插直径 Standing Diameter | 2.4m-2.6m | | | |

| 工作压力 Working Pressure | | 1.5Bar | | 2.0Bar | | 2.5Bar | | 3.0Bar | |
|-----------------------|----------------------|-----------------|----------------|-----------------|----------------|-----------------|----------------|-----------------|----------------|
| 货号 Item No. | 喷嘴颜色 Nozzle Color | 流量 Discharge | 直径 Diameter | 流量 Discharge | 直径 Diameter | 流量 Discharge | 直径 Diameter | 流量 Discharge | 直径 Diameter |
| MJ4002 | Gray | 42.20L/h | 2.2m | 47.50L/h | 2.6m | 51.70L/h | 2.8m | 58.40L/h | 3.0m |
| MJ4003 | Black | 59.00L/h | 2.6m | 68.60L/h | 3.0m | 76.20L/h | 3.2m | 83.20L/h | 3.4m |
| MJ4004 | Green | 79.30L/h | 3.0m | 97.00L/h | 3.4m | 100.60L/h | 3.8m | 106.20L/h | 4.2m |
| MJ4005 | Blue | 96.20L/h | 3.4m | 109.40L/h | 4.0m | 123.00L/h | 4.2m | 126.10L/h | 4.4m |
| MJ4006 | Red | 128.00L/h | 4.0m | 144.80L/h | 4.4m | 155.80L/h | 4.6m | 179.00L/h | 5.0m |
| MJ4007 | Yellow | 149.00L/h | 4.2m | 168.00L/h | 4.6m | 189.60L/h | 5.0m | 213.60L/h | 5.2m |

8908 131 8792

雾化喷头 Fogger & Mister
*KOM-60
6 ym*

| 产品名称 Product Description | 图片 Picture | 货号 Item No. | 规格 Size | 每袋数量 Qty/Bag (Pc) | 每箱数量 Qty/Ctn (Pc) | 纸箱规格 Ctn Size (Cm) | 毛重 G.W (Kg) |
|------------------------------|---------------|----------------|-----------------------------------|-------------------------|-------------------------|--------------------------|-------------------|
| 四出口雾化喷头 4 Outlet Fogger | | MJ1301A | 绿色喷嘴 Green Nozzle | 100 | 1200 | 54*35*28 | 18 |
| | | MJ1301B | 灰色喷嘴 Grey Nozzle | 100 | 1200 | 54*35*28 | 18 |
| 三出口雾化喷头 3 Outlet Fogger | | MJ1301AT | 绿色喷嘴 Green Nozzle | 100 | 1200 | 54*35*28 | 18 |
| | | MJ1301BT | 灰色喷嘴 Grey Nozzle | 100 | 1200 | 54*35*28 | 18 |
| 一出口雾化喷头 One Outlet Fogger | | MJ1311 | 黑色喷嘴 Black Nozzle | 100 | 10000 | 54*35*28 | 26 |
| | | MJ1312 | 灰色喷嘴 Grey Nozzle | 100 | 10000 | 54*35*28 | 26 |
| 一出口雾化喷头 Mist Sprager | | MT0108T | 红色喷嘴 1/4" Thread Red Nozzle | 100 | 7000 | 54*35*28 | 19 |
| 弯喷头 Elbow Mister | | MT0208 | 黑色喷嘴 Black Nozzle | 100 | 11000 | 54*35*28 | 17 |
| 螺口式全圆 折射喷头 Microjet | | MJ1412 | 62L/h@2bar | 500 | 24000 | 42*28*21 | 14 |

技术参数 Technical Data:

| 货号 Item No. | 工作压力 Working Pressure | | | | |
|----------------|--------------------------|----------|--------|--------|---------|
| | | 2.5Bar | 3.0Bar | 3.5Bar | 4.0Bar |
| MJ1301A | 流量 Discharge | 26L/h | 28L/h | 30L/h | 31L/h |
| | 倒挂直径 Hanged Diameter | 1.6-2.0m | | | |
| MJ1301B | 流量 Discharge | 32L/h | 35L/h | 38L/h | 40L/h |
| | 倒挂直径 Hanged Diameter | 1.6-2.0m | | | |
| MJ1301AT | 流量 Discharge | 20L/h | 21L/h | 23L/h | 24L/h |
| | 倒挂直径 Hanged Diameter | 1.6-2.0m | | | |
| MJ1301BT | 流量 Discharge | 24L/h | 25L/h | 29L/h | 30L/h |
| | 倒挂直径 Hanged Diameter | 1.6-2.0m | | | |
| MJ1311 | 流量 Discharge | 8.0L/h | 8.8L/h | 9.5L/h | 10.0L/h |
| | 倒挂直径 Hanged Diameter | 0.5-0.6m | | | |
| MJ1312 | 流量 Discharge | 6.0L/h | 6.7L/h | 7.2L/h | 7.7L/h |
| | 倒挂直径 Hanged Diameter | 0.4-2.0m | | | |

| 货号 Item No. | 工作压力 Working Pressure | | | | |
|----------------|--------------------------|----------|--------|---------|---------|
| | | 1.5Bar | 2.0Bar | 2.5Bar | 3.0Bar |
| MT0208 | 流量 Discharge | 8.7L/h | 9.3L/h | 10.6L/h | 11.8L/h |
| | 射程直径 Standing Diameter | 0.8-1.0m | | | |
| MT0104T | 流量 Discharge | 10L/h | 14L/h | 19L/h | 23L/h |
| | 射程直径 Standing Diameter | 0.8-1.0m | | | |
| MT0108T | 流量 Discharge | 30L/h | 36L/h | 42L/h | 50L/h |
| | 射程直径 Standing Diameter | 1.6-1.8m | | | |
| MJ1412 | 流量 Discharge | 53L/h | 62L/h | 70L/h | 82L/h |
| | 射程直径 Standing Diameter | 2.2-2.4m | | | |

微喷头配件 Accessory for Microspray

| 产品名称 Product Description | 图片 Picture | 货号 Item No. | 规格 Size | 每袋数量 Qty/Bag(Pc) | 每箱数量 Qty/Ctn(Pc) | 纸箱规格 Ctn Size(Cm) | 毛重 G.W(Kg) |
|--|---|----------------|--------------------|---------------------|---------------------|----------------------|---------------|
| 双边承插式防滴器 Mini Anti-drainage Valve |  | 4100 | Dn7 Socket | 100 | 6000 | 54*35*28 | 19 |
| 单边倒刺防滴器 Mini Anti-drainage Valve |  | 4101 | Dn7 Barb*Socket | 100 | 6500 | 54*35*28 | 20 |
| 双边承插式直接 Double Socket Adaptor |  | 5140 | Dn7 | 100 | 25000 | 54*35*28 | 19 |
| 一边承插一边倒刺直接 One Barbed Adaptor |  | 5141 | Dn7 | 100 | 30000 | 54*35*28 | 21 |
| 双边倒刺式直接 Double Barbed Adapter |  | 5142 | Dn7 | 100 | 30000 | 54*35*28 | 21 |
| 内承插式单边倒刺直接 One Inside Barbed Adaptor |  | 5145 | Dn7 | 100 | 14000 | 54*35*28 | 21 |
| 双边内承插式接头 Double Inside Barbed Adaptor |  | 5147 | Dn7 | 100 | 14000 | 54*35*28 | 18 |

备注

- 防滴器可有效的控制倒挂微喷头配件在阀门关紧停水情况下，确保微喷头不滴水，从而有效保护作物。
- 当系统压力高于 0.7-1.0bar 时，水量通过防滴器微喷头开始喷水。
- 当系统压力低于 0.4-0.8bar 时，水量停止通过防滴器微喷头停止喷水。

Note:

- The Mini Anti-drainage vane can prevent the water from leaking the ground and prevent the little planting when microsprinkler or microjet is handed.
- When the pressure in system is up to 0.7-1.0bar, water flow through the Mini Anti-drainage valve.
- When the pressure in system is less than 0.4bar-0.8bar, water would be prevented by mini anti-drainage valve.







微喷头配件 Accessory for Microspray

| 产品名称 Product Description | 图片 Picture | 货号 Item No. | 规格 Size | 每袋数量 Qty/Bag (Pc) | 每箱数量 Qty/Ctn (Pc) | 纸箱规格 Ctn Size (Cm) | 毛重 G.W (Kg) |
|---|---|----------------|-----------------------|----------------------|----------------------|-----------------------|----------------|
| 重锤 Weight Hammer |  | 5321 | 6cm 长 6cm Length | 10 | 350 | 42*28*21 | 16 |
| 管上式堵头 Repairing End Line |  | 5205 | Dn6 | 50 | 20000 | 42*28*21 | 13 |
| 外螺纹变接头 Reducing Connector with Male Threaded |  | 5194 | Dn7*1/2" | 100 | 3500 | 54*35*28 | 18 |
| 内螺纹变接头 Micro Spray Female Adaptor |  | SAT10T | 1/4" *1/2" | 100 | 2000 | 54*35*28 | 16 |
| | | SAT10B | Dn6*1/2" | 100 | 2000 | 54*35*28 | 16 |
| 内螺纹长嘴接头 Micro Spray Female Adaptor |  | CHS250 | Dn6*3/4" | 100 | 1400 | 54*35*28 | 16 |
| 卡扣地插 Clip stake |  | CS0133 | 33cm 长 33cm Length | 10 | 400 | 54*35*28 | 10 |
| | | CS0143 | 43cm 长 43cm Length | 10 | 300 | 54*35*28 | 11 |
| 直立式地插 Straight Stake |  | SS0330 | 30cm 长 30cm Length | 10 | 400 | 54*35*28 | 9 |
| | | SS0340 | 40cm 长 40cm Length | 10 | 350 | 54*35*28 | 11 |
| 直立式地插 Straight Stake |  | SS0150 | 50cm 长 50cm Length | 10 | 320 | 54*35*28 | 12 |



微喷头配件 Accessory for Microspray

| 产品名称 Product Description | 图片 Picture | 货号 Item No. | 规格 Size | 每袋数量 Qty/Bag (Pc) | 每箱数量 Qty/Ctn (Pc) | 纸箱规格 Ctn Size (Cm) | 毛重 G.W (Kg) |
|---|---|----------------|--|-------------------------|-------------------------|--------------------------|-------------------|
| 倒挂三件套 Microsprinkler Hanged Support Set |  | HMS01 | 50cm 长 50cm Length | 10 | 400 | 54*35*28 | 19 |
| 防滴倒挂三件套 Microsprinkler Hanged Support Set with Anti- drainage Valve |  | HMS02 | 50cm 长 50cm Length | 10 | 400 | 54*35*28 | 26 |
| 地插三件套 Microsprinkler Support Stand Set |  | SMS0150 | 50cm 高 50cm 长 50cm Height 50cm Pipe | 10 | 250 | 54*35*28 | 14 |
| 地插全套 地插微喷头 Microsprinkler Support Stand Set |  | SMS0230 | 30cm 高 50cm 长 30cm Height 50cm Pipe | 10 | 250 | 54*35*28 | 14 |
| | | SMS0240 | 40cm 高 50cm 长 40cm Height 50cm Pipe | 10 | 200 | 54*35*28 | 12 |
| PVC 软管 PVC Soft Pipe |  | PV010474 | Dn7 / 4mm, 4Bar | 300 m/roll | 3rolls/bag | Dn45*60 | 29 |



超十旋转喷头 Super Sprayer and Accessory

| 产品名称 Product Description | 图片 Picture | 货号 Item No. | 规格 Size | 每袋数量 Qty/Bag (Pc) | 每箱数量 Qty/Ctn (Pc) | 纸箱规格 Ctn Size (Cm) | 毛重 G.W (Kg) |
|--|---|----------------|----------------------------|-------------------------|-------------------------|--------------------------|-------------------|
| 超十旋转喷头 Super Sprayer |  | SP3302 | 1/2" | 10 | 300 | 54*35*28 | 15 |
| | | SP3303 | 1/2" | 10 | 300 | 54*35*28 | 15 |
| 内螺丝支架接头 Support with Female Thread |  | 5193 | Dn12*1/2" | 100 | 900 | 54*35*28 | 13 |
| 内螺纹地插接头 Support with Female Thread |  | ST5234 | Dn16*3/4" Length:14.5cm | 10 | 300 | 54*35*28 | 13 |
| 旁通接头 Offtake Connector |  | 5191 | Dn10*8 | 500 | 12000 | 54*35*28 | 16 |
| 承插接头 Barb Connector |  | 5192 | Dn12*8 | 100 | 8000 | 54*35*28 | 12 |
| 堵头 End Line |  | 5195 | Dn8 | 500 | 20000 | 54*35*28 | 16 |

| 货号 Item No. | 工作压力 Working Pressure | 1.5Bar | 2.5Bar | 3.0Bar | 3.5Bar | 4.0Bar |
|--------------------------|---------------------------|--------|--------|--------|--------|--------|
| SP3302 (Blue Nozzle) | 流量 Discharge | 417L/h | 465L/h | 510L/h | 545L/h | 591L/h |
| | 射程直径 Standing Diameter | 15-16m | | | | |
| SP3303 (Green Nozzle) | 流量 Discharge | 511L/h | 567L/h | 625L/h | 673L/h | 717L/h |
| | 射程直径 Standing Diameter | 17-18m | | | | |



塑料摇臂喷头 Plastic Impact Sprinkler

| 产品名称 Product Description | 图片 Picture | 货号 Item No. | 规格 Size | 每袋数量 Qty/Bag (Pc) | 每箱数量 Qty/Ctn (Pc) | 纸箱规格 Ctn Size (Cm) | 毛重 G.W (Kg) |
|-------------------------------------|---|----------------|------------------|----------------------|----------------------|-----------------------|----------------|
| 外螺纹摇臂喷头 Plastic Impact Sprinkler |  | RS5022 | 1/2" Male Thread | 1 | 200 | 54*35*28 | 12 |
| 外螺纹摇臂喷头 Plastic Impact Sprinkler |  | RS5035 | 3/4" Male Thread | 1 | 100 | 54*35*28 | 14 |

Technical Data:

| 喷嘴直径 喷嘴颜色 货号 Item No Nozzle Diameter Nozzle Color | 压力 Pressure (bar) | 单喷嘴流量 Single-nozzle Discharge (m ³ /h) | 双喷嘴流量 Double-nozzle Discharge (m ³ /h) | 射程 Spray Radius (m) | 喷嘴直径 喷嘴颜色 货号 Item No Nozzle Diameter Nozzle Color | 压力 Pressure (bar) | 单喷嘴流量 Single-nozzle Discharge (m ³ /h) | 双喷嘴流量 Double-nozzle Discharge (m ³ /h) | 射程 Spray Radius (m) |
|---|-------------------------|--|--|------------------------------|---|-------------------------|--|--|------------------------------|
| RS5022-2 2.5+1.6 Purple+Brown | 2 3 4 | 0.32 0.40 0.47 | 0.47 0.58 0.67 | 9.5 10.0 10.0 | RS5035-2 4.0+3.0 Black+Grey | 3 4 5 | 1.02 1.19 1.34 | 1.45 1.68 1.88 | 13.0 13.5 14.0 |
| RS5022-3 2.8+1.6 Orange+Brown | 2 3 4 | 0.42 0.52 0.60 | 0.55 0.70 0.81 | 9.5 10.0 10.0 | RS5035-3 4.5+3.0 Brown+Grey | 3 4 5 | 1.29 1.50 1.69 | 1.66 1.94 2.18 | 14.0 14.5 15.0 |
| RS5022-4 3.0+1.6 Red+Brown | 2 3 4 | 0.48 0.59 0.69 | 0.61 0.76 0.88 | 10.0 10.5 10.5 | RS5035-4 5.0+3.0 Purple+Grey | 3 4 5 | 1.58 1.84 2.07 | 1.95 2.28 2.56 | 14.5 15.0 16.0 |
| RS5022-5 3.2+1.6 Green+Brown | 2 3 4 | 0.54 0.68 0.79 | 0.68 0.85 0.99 | 10.5 10.5 11.0 | RS5035-5 5.5+3.0 Orange+Grey | 3 4 5 | 1.91 2.23 2.51 | 2.29 2.65 3.00 | 15.0 16.0 16.5 |
| RS5022-6 3.5+1.6 Blue+Brown | 2 3 4 | 0.64 0.80 0.94 | 0.78 0.97 1.14 | 10.5 11.0 11.0 | RS5035-6 6.0+3.0 Red+Grey | 3 4 5 | 2.21 2.57 2.90 | 2.57 3.00 3.38 | 15.0 16.5 17.0 |
| RS5022-7 4.0+1.6 Black+Brown | 2 3 4 | 0.82 1.03 1.22 | 0.95 1.20 1.43 | 11.0 11.5 11.5 | RS5035-7 6.5+3.0 Gray+Grey | 3 4 5 | 2.55 2.97 3.35 | 2.92 3.40 3.83 | 16.0 17.0 17.5 |



LDPE 软管

- 采用优质聚乙烯原料生产，同时添加抗 UV 和抗老化剂更加耐用。
- 公制，有多种规格和压力等级可供选择。
- 主要运用于灌溉系统中的主管道和分支管道。

LDPE Tubing

- Polyethylene hose manufactured from the highest grade of polyethylene resins, which provide maximum resistance to UV degradation and stress cracking.
- Various diameters, coil lengths and working pressure are available for selection.
- Ideal for installation of mainline and sub-line in irrigation system.













| 产品名称 Product Description | 货号 Item No. | 产品名称 Product Description | 单位 Unit | 包装 Package (m/roll) | 包装规格 Package Size (Cm) | 毛重 G.W (Kg) |
|---|----------------|---|------------|---------------------------|------------------------------|-------------------|
|  | LP010605 | Dn6 , 0.5mm , 4.0Bar | m | 1000 | Dn40*40 | 11 |
| | LP010610 | Dn6 , 1mm , 6.0Bar | m | 1000 | Dn40*40 | 17 |
| | LP010806 | Dn8 , 0.6mm , 2.5Bar | m | 800 | Dn50*42 | 13 |
| | LP010808 | Dn8 , 0.8mm , 4.0Bar | m | 800 | Dn50*42 | 16 |
| | LP010812 | Dn8 , 1.2mm , 6.0Bar | m | 800 | Dn50*42 | 21 |
| | LP011208 | Dn12 , 0.8mm , 2.5Bar | m | 500 | Dn70*30 | 16 |
| | LP011210 | Dn12 , 1mm , 4.0Bar | m | 500 | Dn70*30 | 19 |
| | LP011214 | Dn12 , 1.4mm , 6.0Bar | m | 500 | Dn70*30 | 25 |
| | LP011610 | Dn16 , 1mm , 2.5Bar | m | 500 | Dn90*30 | 26 |
| | LP011612 | Dn16 , 1.2mm , 4.0Bar | m | 500 | Dn90*30 | 27 |
| | LP011616 | Dn16 , 1.6mm , 6.0Bar | m | 500 | Dn90*30 | 38 |
| | LP012012 | Dn20 , 1.2mm , 2.5Bar | m | 200 | Dn75*30 | 15 |
| | LP012015 | Dn20 , 1.5mm , 4.0Bar | m | 200 | Dn75*30 | 18 |
| | LP012020 | Dn20 , 2mm , 6.0Bar | m | 200 | Dn75*30 | 23 |
| | LP012514 | Dn25 , 1.4mm , 2.5Bar | m | 200 | Dn90*35 | 22 |
| | LP012519 | Dn25 , 1.9mm , 4.0Bar | m | 200 | Dn90*35 | 29 |
| | LP012523 | Dn25 , 2.3mm , 6.0Bar | m | 200 | Dn90*35 | 33 |
| | LP021613 | 外白内黑 White Color Outside Dn16 , 1.3mm , 4.0Bar | m | 500 | Dn90*30 | 26 |

备注：外层白色 PE 管可以有效防止太阳曝晒下管内水温升高，避免烫伤作物

Note: Under the sun exposure, the PE pipe with white color outside can be effective to prevent water from high temperature and avoid to hurt the crops.

微灌管用配件 Fitting for Tubing

| 产品名称 Product Description | 图片 Picture | 货号 Item No. | 规格 Size | 每袋数量 Qty/Bag | 每箱数量 Qty/Ctn (Pc) | 纸箱规格 Ctn Size (Cm) | 毛重 G.W (Kg) |
|---|---|----------------|------------|-----------------|-------------------------|--------------------------|-------------------|
| 管用旁通接头 Offtake for PE Pipe |  | OP0112 | Dn12 | 100 | 4500 | 54*35*28 | 19 |
| | | OP0116 | Dn16 | 100 | 3500 | 54*35*28 | 19 |
| | | OP0120 | Dn20 | 100 | 1800 | 54*35*28 | 18 |
| 管用旁通接头 (带双层胶圈) Offtake for PVC Pipe |  | OP0112R | Dn12 | 100 | 2800 | 54*35*28 | 22 |
| | | OP0116R | Dn16 | 100 | 2300 | 54*35*28 | 18 |
| | | OP0120R | Dn20 | 100 | 1400 | 54*35*28 | 19 |
| 新款管用旁通接头 (带双层胶圈) New Type Offtake for PVC Pipe |  | OP0216R | Dn16 | 100 | 1800 | 54*35*28 | 16 |
| PVC 管用旁通三通 Offtake Tee for PVC Pipe |  | OT0116R | Dn16 | 100 | 1300 | 54*35*28 | 10 |
| 管用倒刺直通 Straight Connector |  | SC0116 | Dn16 | 100 | 2800 | 54*35*28 | 18 |
| | | SC0120 | Dn20 | 100 | 1100 | 54*35*28 | 17 |
| | | SC0125 | Dn25 | 100 | 1000 | 54*35*28 | 15 |
| 管用变接头 Reducing Connector |  | RC011612 | Dn16*12 | 100 | 2800 | 54*35*28 | 19 |
| | | RC012016 | Dn20*16 | 100 | 1200 | 54*35*28 | 11 |
| 外螺纹管用接头 Male Threaded Connector |  | MC011612 | Dn16*1/2" | 100 | 2100 | 54*35*28 | 15 |
| | | MC011634 | Dn16*3/4" | 100 | 1200 | 54*35*28 | 13 |
| | | MC012012 | Dn20*1/2" | 100 | 1600 | 54*35*28 | 17 |
| | | MC012034 | Dn20*3/4" | 100 | 1000 | 54*35*28 | 11 |
| | | MC012534 | Dn25*3/4" | 100 | 1000 | 54*35*28 | 12 |
| 内螺纹管用接头 Female Threaded Connector |  | FC011612 | Dn16*1/2" | 100 | 1000 | 54*35*28 | 16 |
| | | FC011634 | Dn16*3/4" | 100 | 800 | 54*35*28 | 14 |
| 涂塑软管旁通接头 Barb Connector for Lay Flat Hose |  | BL0116 | Dn16 | 50 | 700 | 54*35*28 | 17 |
| | | BL0120 | Dn20 | 50 | 600 | 54*35*28 | 18 |
| 管用倒刺弯头 Elbow Connector |  | EC0116 | Dn16 | 100 | 2100 | 54*35*28 | 10 |
| | | EC0120 | Dn20 | 50 | 1200 | 54*35*28 | 12 |
| | | EC0125 | Dn25 | 50 | 700 | 54*35*28 | 10 |
| 外螺纹管用倒刺弯头 Elbow With Male Thread |  | EC021612 | Dn16*1/2" | 100 | 1500 | 54*35*28 | 15 |

| 产品名称 Product Description | 图片 Picture | 货号 Item No. | 规格 Size | 每袋数量 Qty/Bag (Pc) | 每箱数量 Qty/Ctn (Pc) | 纸箱规格 Ctn Size (Cm) | 毛重 G.W (Kg) |
|---|---|----------------|---------------|-------------------------|-------------------------|--------------------------|-------------------|
| 管用倒刺三通 Tee Connector |  | TC0116 | Dn16 | 100 | 1300 | 54*35*28 | 10 |
| | | TC0120 | Dn20 | 50 | 700 | 54*35*28 | 10 |
| | | TC0125 | Dn25 | 50 | 400 | 54*35*28 | 9 |
| 折叠式管用堵头 End Line |  | EL0116 | Dn16 | 100 | 3000 | 54*35*28 | 11 |
| | | EL0120 | Dn20 | 100 | 1600 | 54*35*28 | 12 |
| 承插式管用堵头 Barb End Line |  | EL0216 | Dn16 | 100 | 4000 | 54*35*28 | 19 |
| | | EL0220 | Dn20 | 100 | 2000 | 54*35*28 | 19 |
| 双边外丝接头 Nipple |  | NP0112 | 1/2" | 100 | 1800 | 54*35*28 | 14 |
| | | NP0134 | 3/4" | 100 | 1000 | 54*35*28 | 13 |
| | | NP0110 | 1" | 50 | 500 | 54*35*28 | 13 |
| | | NP0132 | 1-1/2" | 6 | 240 | 54*35*28 | 11 |
| | | NP0150 | 2" | 5 | 160 | 54*35*28 | 12 |
| 地插固定支架 Holddown Support |  | HS0112 | Dn12 | 100 | 1400 | 54*35*28 | 9 |
| | | HS0216 | Dn16 | 100 | 4000 | 54*35*28 | 28 |
| 夹紧圈 Safety Ring |  | SR0116 | Dn16 | 100 | 2800 | 42*28*21 | 5 |
| 悬挂固定管夹 Hanging Clamp for PE pipe |  | HC0116 | Dn16 | 100 | 2200 | 42*28*21 | 8 |
| 地插支架 Support Stake, 8cm Length |  | SS0407 | Dn7 8cm | 100 | 5000 | 42*28*21 | 6 |
| 多用途地插固定支架 Multiple Support, 15cm Length |  | MS0137 | 3*7mm 15cm | 100 | 2200 | 42*28*21 | 9 |
| 涂塑软管旁通接头 Starter Connector for Layflat |  | SC013812 | 3/8" *1/2" | 100 | 1000 | 54*35*28 | 17 |
| 双层胶圈 H Grommet |  | RR011608 | Dn16*8 | 500 | 7500 | 54*35*28 | 20 |
| 大双层胶圈 H Grommet |  | RR011610 | Dn16*10 | 500 | 6000 | 54*35*28 | 18 |
| 单层胶圈 T Grommet |  | RR021608 | Dn16*8 | 500 | 6000 | 54*35*28 | 19 |

微灌管用阀门 Mini Valve for Tubing

| 产品名称 Product Description | 图片 Picture | 货号 Item No. | 规格 Size | 每袋数量 Qty/Bag (Pc) | 每箱数量 Qty/Ctn (Pc) | 纸箱规格 Ctn Size (Cm) | 毛重 G.W (Kg) |
|---|---|----------------|------------|-------------------------|-------------------------|--------------------------|-------------------|
| 承插直通阀门 Maxi Valve |  | MV0116 | Dn16 | 50 | 600 | 54*35*28 | 15 |
| | | MV0120 | Dn20 | 50 | 550 | 54*35*28 | 14 |
| 外螺纹承插阀门 Thread-barb Valve |  | TV011216 | Dn1/2"*16 | 50 | 550 | 54*35*28 | 16 |
| | | TV011220 | Dn1/2"*20 | 50 | 550 | 54*35*28 | 14 |
| | | TV013416 | Dn3/4"*16 | 50 | 450 | 54*35*28 | 14 |
| | | TV013420 | Dn3/4"*20 | 50 | 450 | 54*35*28 | 14 |
| 双头外螺纹阀门 Threaded Male-Male Valve |  | MM0134 | 3/4"*3/4" | 50 | 400 | 54*35*28 | 14 |
| 内外螺纹阀门 Threaded Male-Female Valve |  | MF011212 | 1/2"*1/2" | 50 | 400 | 54*35*28 | 13 |
| | | MF013434 | 3/4"*3/4" | 50 | 350 | 54*35*28 | 15 |
| 内螺纹承插阀门 Barb-Female Thread Valve |  | BF011612 | Dn16*1/2" | 50 | 400 | 54*35*28 | 13 |
| | | BF011634 | Dn16*3/4" | 50 | 400 | 54*35*28 | 13 |
| 承插旁通阀门 (带单层胶圈) Barb Offtake Valve With Rubber Ring |  | OV0416R | Dn16 | 50 | 550 | 54*35*28 | 16 |
| 承插锁扣旁通阀门 Barb Lock Offtake Valve |  | OV0516 | Dn16 | 50 | 500 | 54*35*28 | 17 |
| 涂塑软管旁通阀门 Barb Offtake Valve for Layflat Hose |  | OV0716 | Dn16 | 50 | 300 | 54*35*28 | 15 |
| | | OV0720 | Dn20 | 50 | 300 | 54*35*28 | 15 |

管用配套工具及其他 Accessory Tooling for Tubing

| 产品名称 Product Description | 图片 Picture | 货号 Item No. | 规格 Size | 每袋数量 Qty/Bag (Pc) | 每箱数量 Qty/Ctn (Pc) | 纸箱规格 Ctn Size (Cm) | 毛重 G.W (Kg) |
|--|---|----------------|--------------|-------------------------|-------------------------|--------------------------|-------------------|
| 冲洗阀 Flush Valve |  | FV0234 | 3/4",0.18bar | 100 | 1200 | 54*35*28 | 13 |
| 管上式打孔器 Punch for On-line Dripper |  | PD0104 | Dn4 | 100 | 3500 | 42*28*21 | 13 |
| 简易打孔器 Simple Punch |  | SP0103 | Dn3 | 10 | 450 | 54*35*28 | 28 |
| | | SP0108 | Dn8 | 10 | 450 | 54*35*28 | 28 |
| 握式打孔器 Handle Punch |  | SP250 | Dn3 | 1 | 60 | 42*28*21 | 8 |
| 压力表外牙接头 Take Pressure Adaptor |  | TP0114 | 1/4" | 100 | 2400 | 42*28*21 | 10 |
| 压力表快速接头 Steack for Gauge |  | SG0114 | 1/4" | 100 | 4000 | 42*28*21 | 6 |
| 涂塑软管打孔器 Punch for Lay Flat Hose |  | PF0215 | Dn15 | 1 | 50 | 42*28*21 | 9 |
| | | PF0217 | Dn17 | 1 | 50 | 42*28*21 | 9 |



塑料过滤器 Plastic Filter

- 外壳采用优质复合塑料生产，耐压、抗冲击、坚固耐用。
- 过滤内芯有不锈钢网和叠片两种可供选择，适应不同需要。
- 可过滤不同水质，广泛应用于农业和工业的水处理。
- 多种标准规格可供选择，满足不同需求。
- 易于安装和操作。

- Housings made of very strong plastic, designed to resist great pressure which can be used for long time.
- Two size of filter element can be chose , one is stainless screen and the other size is disc which can meet different requirement.
- Can filter many kinds of water quality and apply for the water treatment both in Agriculture and Industry.
- Many sizes available can be met widely demands.
- Easy installation and operation.

小型塑料过滤器 Micro Plastic Filter

| 产品名称 Product Description | 图片 Picture | 货号 Item No. | 规格 Size | 每袋数量 Qty/Bag (Pc) | 每箱数量 Qty/Ctn (Pc) | 纸箱规格 Ctn Size (Cm) | 毛重 G.W (Kg) |
|---|---|----------------|----------------------------|-------------------------|-------------------------|--------------------------|-------------------|
| 网式过滤器 120 目 Screen Filter, 120 Mesh |  | 1725S120MBT | 3/4"BSP 外螺纹 | 1 | 40 | 54*35*28 | 9 |
| | | 1725S120MNT | 3/4"NPT 外螺纹 | 1 | 40 | 54*35*28 | 9 |
| | | 1725S120MHT | 3/4"Hose 外螺纹 | 1 | 40 | 54*35*28 | 9 |
| 叠片过滤器 120 目 Disc Filter, 120 Mesh |  | 1725D120MBT | 3/4"BSP 外螺纹 | 1 | 40 | 54*35*28 | 12 |
| | | 1725D120MNT | 3/4"NPT 外螺纹 | 1 | 40 | 54*35*28 | 12 |
| | | 1725D120MHT | 3/4"Hose 外螺纹 | 1 | 40 | 54*35*28 | 12 |
| 网式过滤器 120 目 Screen Filter, 120 Mesh |  | 1732S120MBT | 1"BSP 外螺纹 | 1 | 40 | 54*35*28 | 11 |
| | | 1732S120MNT | 1"NPT 外螺纹 | 1 | 40 | 54*35*28 | 11 |
| 叠片过滤器 120 目 Disc Filter, 120 Mesh |  | 1732D120MBT | 1" BSP 外螺纹 | 1 | 40 | 54*35*28 | 12 |
| | | 1732D120MNT | 1" NPT 外螺纹 | 1 | 40 | 54*35*28 | 12 |
| 网式过滤器 Screen In-line Filter 120Mesh |  | 1825S120FHF | 3/4"*3/4"Hose 外螺纹 * 内螺纹 | 10 | 120 | 42*28*21 | 7 |

技术参数 Technical Data:





| 货号 Item No. | 规格 Size | 过滤模式 Filter Elements | 过滤目数 Filtration Grade | 过滤面积 Filter Surface (cm ²) | 最大工作压力 Max.pressure (bar) | 最大流量 Max.flow (m ³ /h) |
|----------------|------------|-------------------------|-----------------------------|--|---------------------------------|---|
| 1725S120M | 3/4" | 网式 / Screen | 120 Mesh | 90 | 10 | 5 |
| 1725D120M | 3/4" | 叠片 / Disc | 120 Mesh | 90 | 10 | 4 |
| 1732S120M | 1" | 网式 / Screen | 120 Mesh | 90 | 10 | 5 |
| 1732D120M | 1" | 叠片 / Disc | 120 Mesh | 90 | 10 | 4 |
| 1825S120FHT | 3/4" | 网式 / Screen | 120 Mesh | 17 | 8 | 1.8 |

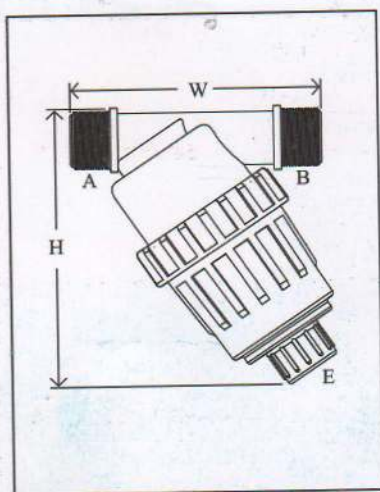



外观尺寸 Messure:

| 货号 Item No. | A | B | C | E | M | H(mm) | W(mm) | X(mm) | Weight(Kg) |
|-----------------------|----------|----------|---|---------|---|-------|-------|-------|-------------|
| 1725S120M / 1725D120M | 3/4"Male | 3/4"Male | - | 3/4"BSP | - | 163 | 125 | - | 0.20 / 0.30 |
| 1732S120M / 1732D120M | 1"Male | 1"Male | - | 1"BSP | - | 168 | 134 | - | 0.20 / 0.30 |



中型塑料过滤器 Medium Plastic Filter

| 产品名称 Product Description | 图片 Picture | 货号 Item No. | 规格 Size | 每袋数量 Qty/Bag (Pc) | 每箱数量 Qty/Ctn (Pc) | 纸箱规格 Ctn Size (Cm) | 毛重 G.W (Kg) |
|---|---|----------------|--|-------------------------|-------------------------|--------------------------|-------------------|
| T 型网式过滤器 120 目 T Screen Filter, 120 Mesh |  | T1763S120B | 2"BSP 外螺纹 2" BSP Male Thread | 1 | 10 | 54*35*28 | 9 |
| | | T1763S120N | 2"NPT 外螺纹 2" NPT Male Thread | 1 | 10 | 54*35*28 | 9 |
| T 型叠片过滤器 120 目 T Disc Filter, 120mesh |  | T1763D120B | 2"BSP 外螺纹 2" BSP Male Thread | 1 | 10 | 54*35*28 | 12 |
| | | T1763D120N | 2"NPT 外螺纹 2" NPT Male Thread | 1 | 10 | 54*35*28 | 12 |
| T 型网式过滤器 120 目 T Screen Filter, 120mesh |  | T1750S120B | 1-1/2"BSP 外螺纹 1-1/2" BSP Male Thread | 1 | 10 | 54*35*28 | 7 |
| | | T1750S120N | 1-1/2"BSP 外螺纹 1-1/2"NPT Male Thread | 1 | 10 | 54*35*28 | 7 |
| T 型叠片过滤器 120 目 T Disc Filter, 120mesh |  | T1750D120B | 1-1/2"BSP 外螺纹 1-1/2" BSP Male Thread | 1 | 10 | 54*35*28 | 12 |
| | | T1750D120N | 1-1/2"BSP 外螺纹 1-1/2" BSP Male Thread | 1 | 10 | 54*35*28 | 12 |
| Y 型网式过滤器, 120 目 Y Screen Filter, 120mesh |  | Y1750S120B | 1-1/2" BSP 外螺纹 1-1/2" BSP Male Thread | 1 | 7 | 54*35*28 | 7 |
| Y 型叠片过滤器, 120 目 Y Disc Filter, 120mesh |  | Y1750D120B | 1-1/2" BSP 外螺纹 1-1/2" BSP Male Thread | 1 | 7 | 54*35*28 | 10 |

| 产品名称 Product Description | 图片 Picture | 货号 Item No. | 规格 Size | 每袋数量 Qty/Bag (Pc) | 每箱数量 Qty/Ctn (Pc) | 纸箱规格 Ctn Size (Cm) | 毛重 G.W (Kg) |
|--|--|----------------|----------------------------------|-------------------------|-------------------------|--------------------------|-------------------|
| Y型网式过滤器, 120目 Y Screen Filter, 120mesh |  | Y1763S120B | 2" BSP 外螺纹 2" BSP Male Thread | 1 | 7 | 54*35*28 | 7 |
| Y型叠片过滤器, 120目 Y Disc Filter, 120mesh |  | Y1763D120B | 2" BSP 外螺纹 2" BSP Male Thread | 1 | 7 | 54*35*28 | 10 |
| Y型加大网式过滤器, 120目 Y Super Screen Filter, 120mesh |  | YB1763S120B | 2" BSP 外螺纹 2" BSP Male Thread | 1 | 4 | 54*35*28 | 7 |
| Y型加大叠片过滤器, 120目 Y Super Disc Filter, 120mesh |  | YB1763D120B | 2" BSP 外螺纹 2" BSP Male Thread | 1 | 4 | 54*35*28 | 8 |



中型塑料过滤器 Plastic Filter

技术参数 Technical Data:

| 货号 Item No. | 规格 Size | 过滤模式 Filter Elements | 过滤目数 Filtration Grade | 过滤面积 Filter Surface (cm ²) | 最大工作压力 Max.pressure (bar) | 最大流量 Max.flow (m ³ /h) |
|----------------|------------|-------------------------|-----------------------------|--|---------------------------------|---|
| T1763S120B/N | 2" 外螺纹 | 网式 / Screen | 120 Mesh | 246 | 8 | 11 |
| T1763D120B/N | 2" 外螺纹 | 叠片 / Disc | 120 Mesh | 254 | 8 | 10 |
| T1750S120B/N | 1-1/2" 外螺纹 | 网式 / Screen | 120 Mesh | 246 | 8 | 11 |
| T1750D120B/N | 1-1/2" 外螺纹 | 叠片 / Disc | 120 Mesh | 254 | 8 | 10 |
| Y1750S120B | 1-1/2" 外螺纹 | 网式 / Screen | 120 Mesh | 480 | 6 | 13 |
| Y1750D120B | 1-1/2" 外螺纹 | 叠片 / Disc | 120 Mesh | 577 | 6 | 13 |
| Y1763S120B | 2" 外螺纹 | 网式 / Screen | 120 Mesh | 480 | 6 | 13 |
| Y1763D120B | 2" 外螺纹 | 叠片 / Disc | 120 Mesh | 577 | 6 | 13 |
| YB1763S120B | 2" 外螺纹 | 网式 / Screen | 120 Mesh | 763 | 6 | 18 |
| YB1763D120B | 2" 外螺纹 | 叠片 / Disc | 120 Mesh | 879 | 6 | 18 |

外观尺寸 Measure:

| 货号 Item No. | A | B | C | E | M | H(mm) | W(mm) | X(mm) | Weight(Kg) |
|-------------------------|-----------|-----------|---|---------|---------|-------|-------|-------|-------------|
| T1763S120B/T1763D120B | 2"BSP | 2"BSP | - | 3/4"BSP | 1/4"BSP | 341 | 222 | - | 0.90 / 1.10 |
| T1763S120N/T1763D120N | 2"NPT | 2"NPT | - | 3/4"BSP | 1/4"BSP | 341 | 222 | - | 0.90 / 1.10 |
| T1750S120B/T1750D120N | 1-1/2"BSP | 1-1/2"BSP | - | 3/4"BSP | 1/4"BSP | 328 | 205 | - | 0.80 / 1.00 |
| T1750S120N/T1750D120N | 1-1/2"NPT | 1-1/2"NPT | - | 3/4"BSP | 1/4"BSP | 328 | 205 | - | 0.80 / 1.00 |
| Y1763S120B/Y1763D120B | 2"BSP | 2"BSP | - | 3/4"BSP | 1/4"BSP | 260 | 284 | 260 | 0.88 / 1.25 |
| YB1763S120B/YB1763D120B | 2"BSP | 2"BSP | - | 3/4"BSP | 1/4"BSP | 316 | 338 | 290 | 1.38 / 1.75 |
| Y1750S120B/Y1750D120B | 1-1/2"BSP | 1-1/2"BSP | - | 3/4"BSP | 1/4"BSP | 163 | 140 | 240 | 0.87 / 1.24 |

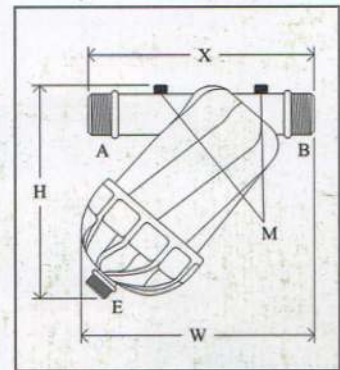
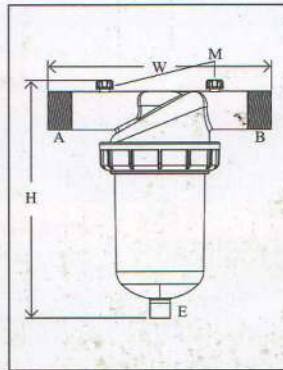

大流量塑料过滤器 Large Plastic Filter

| 产品名称 Product Description | 图片 Picture | 货号 Item No. | 规格 Size | 每袋数量 Qty/Bag (Pc) | 每箱数量 Qty/Ctn (Pc) | 纸箱规格 Ctn Size (Cm) | 毛重 G.W (Kg) |
|---|---|----------------|---|-------------------------|-------------------------|--------------------------|-------------------|
| 2" 叠片过滤器 120目 2" Disc Filter, 120Mesh |  | FD02120B | 2" BSP 外螺纹 2" BSP Male Thread | 1 | 1 | 63*23*33 | 7 |
| | | FD02120N | 2" NPT 外螺纹 2" NPT Male Thread | 1 | 1 | 63*23*33 | 7 |
| 2" 网式过滤器 120目 2" Screen Filter, 120Mesh |  | FS02120B | 2"BSP 外螺纹 2" BSP Male Thread | 1 | 1 | 63*23*33 | 6 |
| | | FS02120N | 2"NPT 外螺纹 2" NPT Male Thread | 1 | 1 | 63*23*33 | 6 |
| 3" 叠片过滤器 120目 3" Disc Filter, 120Mesh |  | FD03120BBB | 3"BSP*3"BSP*3"BSP 外螺纹 3"BSP*3"BSP*3"BSP Male Thread | 1 | 1 | 76*36*24 | 10 |
| | | FD03120VVB | 3" 卡扣 *3" 卡扣 *3"BSP 外螺纹 3"VIC*3"VIC*3"BSP Male Thread | 1 | 1 | 76*36*24 | 10 |
| | | FD03120VBV | 3" 卡扣 *3"BSP 外螺纹 *3" 卡扣 3"VIC*3"BSP Male Thread*3"VIC | 1 | 1 | 76*36*24 | 10 |
| 3" 网式过滤器, 120目 3" Screen Filter, 120Mesh |  | FS03120BBB | 3"BSP*3"BSP*3"BSP 外螺纹 3"BSP*3"BSP*3"BSP Male Thread | 1 | 1 | 76*36*24 | 8 |
| | | FS03120VVB | 3" 卡扣 *3" 卡扣 *3"BSP 外螺纹 3"VIC*3"VIC*3"BSP Male Thread | 1 | 1 | 76*36*24 | 8 |
| | | FS03120VBV | 3" 卡扣 *3"BSP 外螺纹 *3" 卡扣 3"VIC*3"BSP Male Thread*3"VIC | 1 | 1 | 76*36*24 | 8 |
| 4" 叠片过滤器, 120目 4" Disc Filter, 120Mesh |  | FD04120BB | 4"BSP*4"BSP 外螺纹 4"BSP*4"BSP Male Thread | 1 | 1 | 100*38*24 | 12 |
| | | FD04120VV | 4" 卡扣 *4" 卡扣 4"VIC*4"VIC | 1 | 1 | 100*38*24 | 12 |
| 4" 网式过滤器, 120目 4" Screen Filter, 120Mesh |  | FS04120BB | 4"BSP*4"BSP 外螺纹 4"BSP*4"BSP Male Thread | 1 | 1 | 100*38*24 | 8 |
| | | FS04120VV | 4" 卡扣 *4" 卡扣 4"VIC*4"VIC | 1 | 1 | 100*38*24 | 8 |
| 4" 加长叠片过 滤器,120目 4" Super Disc Filter, 120Mesh |  | FD04S120BB | 4"BSP*4"BSP 外螺纹 4"BSP*4"BSP Male Thread | 1 | 1 | 125*38*24 | 14 |
| | | FD04S120VV | 4" 卡扣 *4" 卡扣 4"VIC*4"VIC | 1 | 1 | 125*38*24 | 14 |
| 4" 加长网式 过滤器,120目 4" Super Screen Filter, 120Mesh |  | FS04S120BB | 4"BSP*4"BSP 外螺纹 4"BSP*4"BSP Male Thread | 1 | 1 | 125*38*24 | 12 |
| | | FS04S120VV | 4" 卡扣 *4" 卡扣 4"VIC*4"VIC | 1 | 1 | 125*38*24 | 12 |

大流量塑料过滤器 Large Plastic Filter

技术参数 Technical Data:

| 货号 Item No. | 规格 Size | 过滤模式 Filter Elements | 过滤目数 Filtration Grade | 过滤面积 Filter Surface (cm ²) | 最大工作压力 Max.pressure (bar) | 最大流量 Max.flow (m ³ /h) |
|------------------------|------------|-------------------------|-----------------------------|--|---------------------------------|---|
| FD02120B/N | 2" | 叠片 / Disc | 120 Mesh | 1200 | 10 | 30 |
| FS02120B/N | 2" | 网式 / Screen | 120 Mesh | 965 | 10 | 30 |
| FD03120BBB/ VVB/VBV | 3" | 叠片 / Disc | 120 Mesh | 1700 | 10 | 50 |
| FS03120BBB/ VVB/VBV | 3" | 网式 / Screen | 120 Mesh | 1090 | 10 | 50 |
| FD04120BB/VV | 4" | 叠片 / Disc | 120 Mesh | 2400 | 10 | 70 |
| FS04120BB/VV | 4" | 网式 / Screen | 120 Mesh | 1930 | 10 | 70 |
| FD04S120BB/ VV | 4"Super | 叠片 / Disc | 120 Mesh | 3400 | 10 | 100 |
| FS04S120BB/ VV | 4"Super | 网式 / Screen | 120 Mesh | 2180 | 10 | 100 |

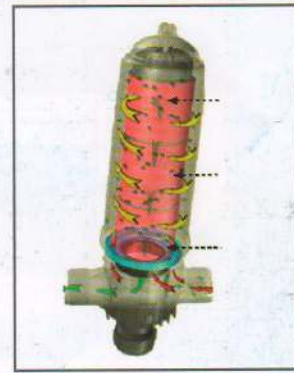
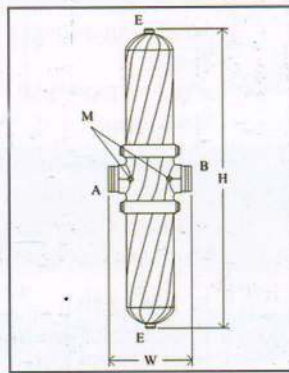
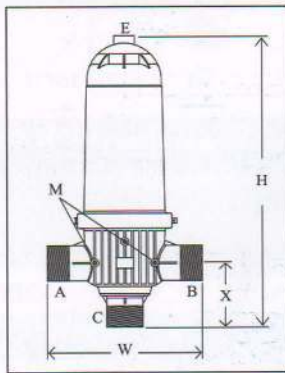



外观尺寸 Messure:

| 货号 Item No. | A | B | C | E | M | H(mm) | W(mm) | X(mm) | Weight(Kg) |
|-------------------------|-------|-------|-------|---------|---------|-------|-------|-------|-------------|
| FD02120B / FS02120B | 2"BSP | 2"BSP | 2"BSP | 3/4"BSP | 1/4"BSP | 595 | 324 | 138 | 7.00 / 6.00 |
| FD02120N / FS02120N | 2"NPT | 2"NPT | 2"NPT | 3/4"BSP | 1/4"NPT | 595 | 324 | 138 | 7.00 / 6.00 |
| FD03120BBB / FS03120BBB | 3"BSP | 3"BSP | 3"BSP | 3/4"BSP | 1/4"BSP | 727 | 336 | 147 | 7.70 / 6.70 |
| FD03120VVB / FS03120VVB | 3"VIC | 3"VIC | 3"BSP | 3/4"BSP | 1/4"BSP | 727 | 336 | 147 | 7.70 / 6.70 |
| FD03120VBV / FS03120VBV | 3"VIC | 3"BSP | 3"VIC | 3/4"BSP | 1/4"BSP | 727 | 336 | 147 | 7.70 / 6.70 |
| FD04120BB / FS04120BB | 4"BSP | 4"BSP | - | 3/4"BSP | 1/4"BSP | 950 | 342 | - | 11.60/8.70 |
| FD04120VV / FS04120VV | 4"VIC | 4"VIC | - | 3/4"BSP | 1/4"BSP | 950 | 342 | - | 11.60/8.70 |
| FD04S120BB / FS04S120BB | 4"BSP | 4"BSP | - | 3/4"BSP | 1/4"BSP | 1200 | 342 | - | 14.00 |
| FD04S120VV / FS04S120VV | 4"VIC | 4"VIC | - | 3/4"BSP | 1/4"BSP | 1200 | 342 | - | 14.00 |

自动反冲洗过滤器 Automatic Self-Cleaning Filter

- 自动反冲洗过滤器具有自动清洗功能，极大提高过滤效率。
- 反冲洗所需水量少和压力低，节水节能。
- 采用离心设计，冲洗更高效，维护更方便。
- 采用独特设计和优质材料，过滤和反冲洗工作稳定，可靠性强。
- 结构紧凑，便于运输和安装。
- 可与多种控制器兼容，便于操作。
- Automatic Self-cleaning Filter with maximum reliability and efficiency in filtration.
- Water and energy saving. Minimum backflushing pressure for maximum efficiency and using minimum water maintaining an efficient cleaning action.
- The helical action optimizes the filtration performance and reduces backwash frequency and maintenance.
- Specially designed and high quality materials used in manufacturing guarantees an extended life with high resistance.
- Compact assembled systems for easy transportation and installation.
- Compatible with various control units, easy operation

| 产品名称 Product Description | 图片 Picture | 货号 Item No. | 规格 Size | 每袋数量 Qty/Bag (Pc) | 每箱数量 Qty/Ctn (Pc) | 纸箱规格 Ctn Size (Cm) | 毛重 G.W (Kg) |
|--|---|----------------|---|-------------------------|-------------------------|--------------------------|-------------------|
| 2" 加长自动反冲洗片过滤器, 120目 2" Super Automatic Self-cleaning Disc Filter, 120Mesh |  | AFD02S120BBB | 2"BSP*2"BSP*2"BSP 外螺纹 2"BSP*2"BSP*1"BSP Male Thread | 1 | 1 | 76*36*24 | 9 |
| | | AFD02S120VVB | 2" 卡扣 *2" 卡扣 *2"BSP 外螺纹 2"VIC*2"VIC*2"BSP Male Thread | 1 | 1 | 76*36*24 | 9 |
| | | AFD02S120VBV | 2" 卡扣 *2"BSP 外螺纹 *2" 卡扣 2"VIC*2"BSP Male Thread*2"VIC | 1 | 1 | 76*36*24 | 9 |
| 3" 自动反冲洗叠片过滤器, 120目 3" Automatic Self-cleaning Disc Filter, 120Mesh |  | AFD03120BBB | 3"BSP*3"BSP*3"BSP 外螺纹 3"BSP*3"BSP*1.5BSP Male Thread | 1 | 1 | 76*36*24 | 10 |
| | | AFD03120VVB | 3" 卡扣 *3" 卡扣 *3"BSP 外螺纹 3"VIC*3"VIC*3"BSP Male Thread | 1 | 1 | 76*36*24 | 10 |
| | | AFD03120VBV | 3" 卡扣 *3"BSP 外螺纹 *3" 卡扣 3"VIC*3"BSP Male Thread*3"VIC | 1 | 1 | 76*36*24 | 10 |
| 4" 加长自动反冲洗叠片过滤器, 120目 4" Super Automatic Self-cleaning Disc Filter, 120Mesh |  | AFD04S120BB | 4"BSP*4"BSP 外螺纹 4"BSP*4"BSP Male Thread | 1 | 1 | 125*38*24 | 17 |
| | | AFD04S120VV | 4" 卡扣 *4" 卡扣 4"VIC*4"VIC | 1 | 1 | 125*38*24 | 17 |

自动反冲洗过滤器 Automatic Self-Cleaning Filter

技术参数 Technical Data:

| 货号 Item No. | 规格 Size | 过滤模式 Filter Elements | 过滤目数 Filtration Grade | 过滤面积 Filter Surface (cm ²) | 最大工作压力 Max.pressure (bar) | 最大流量 Max.flow (m ³ /h) |
|----------------------|------------|-------------------------|-----------------------------|--|---------------------------------|---|
| AFD02S120BBB/VVB/VBV | 2" | 叠片 / Disc | 120 Mesh | 1650 | 10 | 50 |
| AFD03120BBB/VVB/VBV | 3" | 叠片 / Disc | 120 Mesh | 1650 | 10 | 50 |
| AFD04120BB/VV | 4" | 叠片 / Disc | 120 Mesh | 3300 | 10 | 100 |

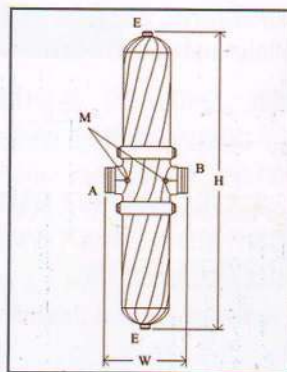
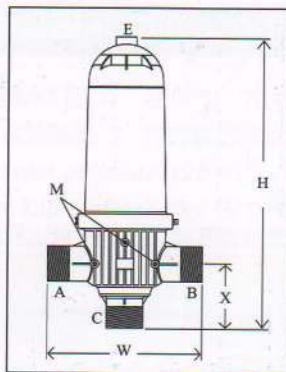

外观尺寸 Measure:

| 货号 Item No. | A | B | C | E | M | H(mm) | W(mm) | X(mm) | Weight(Kg) |
|--------------|-------|-------|-------|---------|---------|-------|-------|-------|------------|
| AFD02S120BBB | 2"BSP | 2"BSP | 2"BSP | 3/4"BSP | 1/4"BSP | 721 | 324 | 138 | 8.10 |
| AFD02S120VVB | 2"VIC | 2"VIC | 2"BSP | 3/4"BSP | 1/4"BSP | 721 | 324 | 138 | 8.10 |
| AFD02S120VBV | 2"VIC | 2"BSP | 2"VIC | 3/4"BSP | 1/4"BSP | 721 | 324 | 138 | 8.10 |
| AFD03120BBB | 3"BSP | 3"BSP | 3"BSP | 3/4"BSP | 1/4"BSP | 727 | 336 | 147 | 8.50 |
| AFD03120VVB | 3"VIC | 3"VIC | 3"BSP | 3/4"BSP | 1/4"BSP | 727 | 336 | 147 | 8.50 |
| AFD03120VBV | 3"VIC | 3"BSP | 3"VIC | 3/4"BSP | 1/4"BSP | 727 | 336 | 147 | 8.50 |
| AFD04S120BB | 4"BSP | 4"BSP | - | 3/4"BSP | 1/4"BSP | 1200 | 342 | - | 15.00 |
| AFD04S120VV | 4"VIC | 4"VIC | - | 3/4"BSP | 1/4"BSP | 1200 | 342 | - | 15.00 |

自动反冲洗流量和压力参数 Automatic Backflushing Data

| 货号 Item No. | AFD02S120BBB/ VVB / VBV | AFD03120BBB/ VVB / VBV | AFD04120BB / VV |
|--|----------------------------|---------------------------|-----------------|
| 最低反冲洗工作压力 Minimum Backflushing Pressure (Bar) | 2.50-3.00 Bar | 2.50-3.00 Bar | 2.50-3.00 Bar |
| 最低反冲洗流量 Minimum Backflushing Flow (L/s) | 2.50 L/s | 2.50 L/s | 5.00 L/s |
| 反冲洗时间 (秒) Backflushing Time (s) | 8-30s | 8-30s | 8-30s |
| 反冲洗耗水量 Backflushing Consumption (L) | 20-75 L | 20-75 L | 40-150 L |

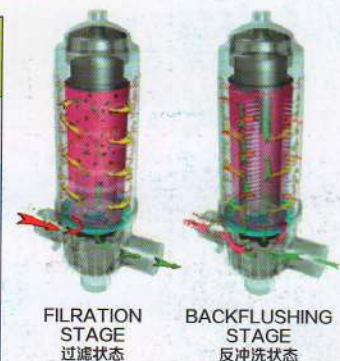

文丘里注肥器 Fertilizer Injector

特点 Advantage:

- 立体一次性成型，结构合理。
- 利用虹吸原理，方便吸入各种液态肥料并注入灌溉管道中，水肥均匀灌溉各种作物。
- 可与注肥器套件配合易于主管道相连接。
- 进出水口为外螺纹接头，方便连接。
- Commercial grade one with no moving parts.
- It works by suction and will draw liquid fertilizer out of almost any container you provide.
- Can be plumbed on a bypass for less restriction(the preferred method),or directly into a main water line.
- All sizes have Male Pipe threads on the inlet and outlet, which are easily adapted to hose threads.

应用 Application:

- 按作物及灌溉面积挑选相应规格注肥器，太大或太小都不利于有效施肥。
- 如无法确定时，挑选规格小的然后与注肥套件配合与主管道并联安装通过调整阀门控制水量达到注肥目的；如果确定注肥器偏小可通过阀门调小水量通过延长时间达到施肥目的。
- Select the appropriate specification of fertilizer Injector depend on the crop and irrigation area. Too big or too small maybe do nothing.
- If in doubt always choose a smaller size, put it on a bypass assembly which allows you to adjust the flow through the venturi injector and does not restrict the flow as much.

| 产品名称 Product Description | 图片 Picture | 货号 Item No. | 规格 Size | 每袋数量 Qty/Bag (Pc) | 每箱数量 Qty/Ctn (Pc) | 纸箱规格 Ctn Size (Cm) | 毛重 G.W (Kg) |
|-----------------------------|---------------|----------------|--------------|-------------------------|-------------------------|--------------------------|-------------------|
| 文丘里式注肥器 Venturi Injector | | VI0112H | 1/2" | 10 | 300 | 54*35*28 | 11 |
| | | VI0134H | 3/4" | 10 | 250 | 54*35*28 | 11 |
| | | VI0110H | 1" | 10 | 100 | 54*35*28 | 12 |
| | | VI0132H | 1-1/2" | 1 | 40 | 54*35*28 | 9 |
| | | VI0150H | 2" | 1 | 25 | 54*35*28 | 8 |
| 过滤吸管套件 Suction Assembly | | SA011234 | 1/2" or 3/4" | 1 | 60 | 54*35*28 | 9 |
| | | SA011032 | 1" or 1-1/2" | 1 | 20 | 54*35*28 | 9 |
| | | SA0120 | 2" | 1 | 10 | 54*35*28 | 10 |

技术参数 Technical Data:

| 货号 Item No. | 规格 Size | At0.8bar | | At1.0bar | | At1.5bar | | At2.0bar | | At2.5bar | | At3.0bar | | At3.5bar | | At4.0bar | |
|----------------|------------|-----------------------------|--------------------------------|-----------------------------|--------------------------------|-----------------------------|--------------------------------|-----------------------------|--------------------------------|-----------------------------|--------------------------------|-----------------------------|--------------------------------|-----------------------------|--------------------------------|-----------------------------|--------------------------------|
| | | 出水量 Outlet Flow (L/h) | 吸水量 Injection Rate (L/h) | 出水量 Outlet Flow (L/h) | 吸水量 Injection Rate (L/h) | 出水量 Outlet Flow (L/h) | 吸水量 Injection Rate (L/h) | 出水量 Outlet Flow (L/h) | 吸水量 Injection Rate (L/h) | 出水量 Outlet Flow (L/h) | 吸水量 Injection Rate (L/h) | 出水量 Outlet Flow (L/h) | 吸水量 Injection Rate (L/h) | 出水量 Outlet Flow (L/h) | 吸水量 Injection Rate (L/h) | 出水量 Outlet Flow (L/h) | 吸水量 Injection Rate (L/h) |
| VI0112H | 1/2" | 280 | 63 | 305 | 70 | 353 | 74 | 389 | 74 | 420 | 71 | 448 | 71 | 447 | 72 | 501 | 72 |
| VI0134H | 3/4" | 880 | 97 | 961 | 107 | 1098 | 114 | 1192 | 113 | 1292 | 113 | 1372 | 113 | 1462 | 113 | 1537 | 113 |
| VI0110H | 1" | 1758 | 158 | 2112 | 244 | 2578 | 265 | 3043 | 357 | 3290 | 356 | 3691 | 352 | 3933 | 349 | 4203 | 351 |
| VI0132H | 1-1/2" | 3540 | 544 | 4140 | 619 | 4980 | 787 | 5880 | 786 | 6480 | 785 | 6720 | 779 | 7704 | 778 | 8100 | 781 |

*备注：在 0.8-4.0 Bar 压力流量范围下有 50% 的水头损失。

* Note: Flow Range at 0.8-4.0 Bar with 50% Pressure Differential.

压力调节阀 Pressure Regulator

特点 Advantage:

- 方便连接城市供水的水龙头，供水压力高时方便调节出水压力。
- 优质的 ABS 主体坚固耐用接头为内外牙有两种牙规可供选择。
- Ideal regulator for Low volume systems connected with outdoor faucets when the rural areas supply water at very high pressure.
- Impact resistant body, with 2 size of thread for choice.

应用范围 Application:

- 最大进水口压力：120PSI；压力调节范围：20-100PSI；流量范围：0.2-6.5GPM。
- 适用安装在阀门、定时器后面避免受到持续高水压的损坏。
- Max inlet pressure 120 PSI, Pressure range from 20-100 PSI and flow range: 0.2-6.5GPM
- Be installed after valve or timer; avoid to be damaged by constant high water pressure.

| 产品名称 Product Description | 图片 Picture | 货号 Item No. | 规格 Size | 每袋数量 Qty/Bag (Pc) | 每箱数量 Qty/Ctn (Pc) | 纸箱规格 Ctn Size (Cm) | 毛重 G.W (Kg) |
|--|---|----------------|--------------------|-------------------------|-------------------------|--------------------------|-------------------|
| 3/4" 低流量 压力调节阀 3/4" Low Flow Pressure Regulator |  | PR013415P | 3/4" FPT*MPT 15PSI | 10 | 200 | 48*28*21 | 8 |
| | | PR013415H | 3/4" FHT*MHT 15PSI | 10 | 200 | 48*28*21 | 8 |
| | | PR013420P | 3/4" FPT*MPT 20PSI | 10 | 200 | 48*28*21 | 8 |
| | | PR013420H | 3/4" FHT*MHT 20PSI | 10 | 200 | 48*28*21 | 8 |
| | | PR013425P | 3/4" FPT*MPT 25PSI | 10 | 200 | 48*28*21 | 8 |
| | | PR013425H | 3/4" FHT*MHT 25PSI | 10 | 200 | 48*28*21 | 8 |
| | | PR013430P | 3/4" FPT*MPT 30PSI | 10 | 200 | 48*28*21 | 8 |
| | | PR013430H | 3/4" FHT*MHT 30PSI | 10 | 200 | 48*28*21 | 8 |
| | | PR013445P | 3/4" FPT*MPT 45PSI | 10 | 200 | 48*28*21 | 8 |
| | | PR013445H | 3/4" FHT*MHT 45PSI | 10 | 200 | 48*28*21 | 8 |

技术参数 Technical Data:

| 货号 Item No. | 规格 Model | 进水压力 Inlet Pressure (PSI) | 出水压力 Outlet Pressure (PSI) | 流量范围 Flow Range (GPM) |
|-------------|----------|---------------------------------|----------------------------------|-----------------------------|
| PR013415P/H | 15PSI | 20-80 | 13-15 | 0.2-6.5 |
| PR013420P/H | 20PSI | 25-80 | 18-20 | 0.2-6.5 |
| PR013425P/H | 25PSI | 30-100 | 24-25 | 0.2-6.5 |
| PR013430P/H | 30PSI | 35-100 | 29-30 | 0.2-6.5 |
| PR013445P/H | 45PSI | 50-100 | 44-45 | 0.2-6.5 |

真空排气阀 Air & Vacuum Relief Valve

特点 Advantage:

- 进排气空气阀，适用于各种灌溉系统应用，系统注水时，空气阀排出管道中大量空气；系统排空时，空气阀吸入大量空气防止真空负压。
- 阀门采用先进的复合气体动力学设计，具有快速进排气；可避免空气积聚，防止形成负压，低压时具有良好的密封性能。
- Air valve is applied for irrigation system or networks of water supply. It evacuates air during pipeline filling and enables large volume air intake in the event of network draining.
- With its advanced aerodynamic design and kinetic orifice, this valve can provide excellent protection against vacuum formation, with improved sealing under low pressure conditions.

应用范围 Application:

- 灌溉系统管网：排出灌溉系统中的空气，避免水泵下游、沿程输水管道以及管道上下坡位置形成负压。
- 灌溉首部：排出空气，防止过滤器、施肥罐处形成负压。
- 灌溉管道高处：排出空气，避免系统高处空气聚集破坏管道。
- Main Irrigation Networks - Air relief and vacuum prevention downstream of pumps, along supply lines and at elevations in main irrigation networks.
- Irrigation Control Heads - Air relief and vacuum prevention at filtration and fertilization stations.
- High part of Irrigation Pipeline System - Air relief, Prevention of pipe broken as for high pressure air.

| 产品名称 Product Description | 图片 Picture | 货号 Item No. | 规格 Size | 每袋数量 Qty/Bag (Pc) | 每箱数量 Qty/Ctn (Pc) | 纸箱规格 Ctn Size (Cm) | 毛重 G.W (Kg) |
|---|---|----------------|------------|-------------------------|-------------------------|--------------------------|-------------------|
| 真空排气阀 Air & Vacuum Relief Valve |  | AV0112B | 1/2"BSP | 100 | 1200 | 42*28*21 | 7 |
| 真空排气阀 Air & Vacuum Relief Valve |  | AV0134B | 3/4"BSP | 10 | 200 | 54*35*28 | 16 |
| | | AV0134N | 3/4"NPT | 10 | 200 | 54*35*28 | 16 |
| | | AV0110B | 1"BSP | 10 | 180 | 54*35*28 | 18 |
| | | AV0110N | 1"NPT | 10 | 180 | 54*35*28 | 18 |
| 双向连续型真空 排气阀 Dual Acting Continuous Air & Vacuum Relief Valve |  | AV0210B | 1"BSP | 1 | 56 | 54*35*28 | 15 |
| | | AV0210N | 1" NPT | 1 | 56 | 54*35*28 | 15 |
| | | AV0232B | 1-1/2"BSP | 1 | 56 | 54*35*28 | 15 |
| | | AV0232N | 1-1/2"NPT | 1 | 56 | 54*35*28 | 15 |
| 双向连续型真空 排气阀 Dual Acting Continuous Air & Vacuum Relief Valve |  | AV0150B | 2"BSP | 1 | 15 | 54*35*28 | 12 |
| | | AV0150N | 2"NPT | 1 | 15 | 54*35*28 | 12 |

产品特性和优点 Advantage:

- 结构简单，性能可靠。
- 阀体采用直流道设计，进排气口尺寸大，流量大。
- 密封浮球移动行程长 - 防止浮球被高速气流吹起导致排气口过早关闭，并且不影响空气吸入或排除。
- 动力低压密封 - 可在低压下 (0.2bar) 保持良好密封性，避免发生漏水现象。
- 所有部件均具有抗腐蚀能力，维护频率低，使用寿命长。
- 系统注水过程中，大量空气快速从进排气口排出；水进入空气阀腔室后，浮球随液位上升关闭快速进排气口。符合气体动力学的阀体设计和浮球防吹起设计，可在水进入空气阀前防止浮球被高速气流吹起导致排气口过早关闭。
- 系统排空时形成负压差，空气向下推动浮球。动力式快速进排气口打开，空气进入空气阀，避免系统内形成负压。
- 系统有压状态下，进排气阀保持关闭。
- Compact, simple and reliable structure.
- Straight flow body with large diameter orifice – High flow rates.
- Aerodynamic full-body kinetic shield – Prevents premature closing without disturbing air intake or discharge.
- Dynamic sealing – Prevents leakage during operation even under low pressure conditions (0.2 bar).
- All parts are fully corrosion, chemical and fertilizer resistant – Lower maintenance and increased life span.
- Pipeline Filling: During the filling process of a pipeline, high air flow is forced out through the kinetic orifice of the air valve. Once water enters the valve's chamber, the float buoyed upwards causes the kinetic orifice to close. The unique aerodynamic structure of the valve body and float ensures that the float cannot be closed before water reaches the valve.
- Pipeline Draining: When a pipeline is drained, a negative differential pressure is created causing atmospheric air to push the float down.
- Pressurized Operation: During pressurized operation the kinetic orifice remains closed.

技术参数 Technical Data:

| 货号 Item No. | 规格 Model | 类型 Valve Type | 最大工作压力 MAX Working Pressure (Psi) | 封水压力 Sealing Pressure (psi) | 排气量 Air Outtake Flow (m ³ /h) | 真空吸入量 Air Intake Flow (m ³ /h) |
|----------------|-------------------|--------------------------------------|--|--------------------------------------|--|---|
| AV0112B | 1/2"BSP | 排气阀 Air Relief Valve | 150 | 6 | 0-35m ³ /h@0-6psi | -80-0m ³ /h @-6-0psi |
| AV0134B/N | 3/4"BSP/NPT | 真空排气阀 Air & Vacuum Relief Valve | 150 | 5 | 0-50m ³ /h@0-5psi | -67-0m ³ /h @-6-0psi |
| AV0110B/N | 1"BSP/NPT | 真空排气阀 Air & Vacuum Relief Valve | 150 | 5 | 0-50m ³ /h@0-5psi | -67-0m ³ /h @-6-0psi |
| AV0210B/N | 1"BSP/NPT | 真空排气阀 Air&Vacuum Relief Valve | 150 | 5 | 0-280m ³ /h@0-5psi | -280-0 m ³ /h @-6-0psi |
| AV0232B/N | 1-1/2"BSP/ NPT | 真空排气阀 Air&Vacuum Relief Valve | 225 | 5 | 0-330m ³ /h@0-5psi | -330-0 m ³ /h @-6-0psi |
| AV0150B/N | 2"BSP/NPT | 双向连续型真空排气阀 Dual Acting Continuous | 225 | 5 | 0-235m ³ /h@0-5psi | -360-0m ³ /h @-6-0psi |

1/2" 排气阀技术参数 1/2" Air Valve Technical Data

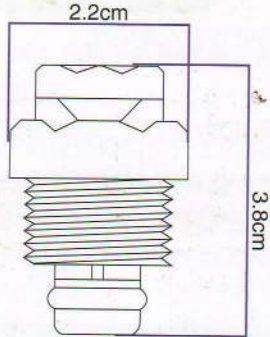

AV0112

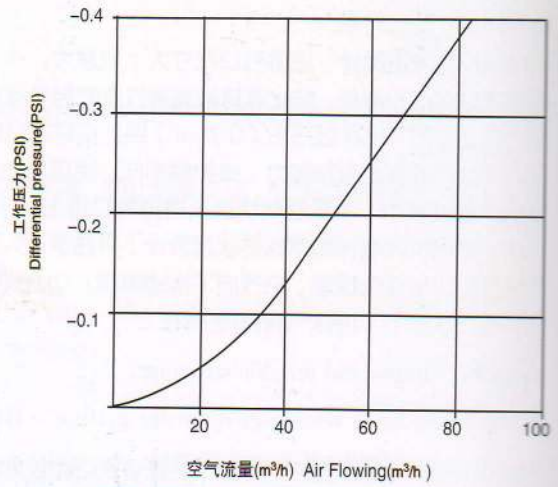

1-1/2" 排气阀技术参数 1-1/2" Air Valve Technical Data

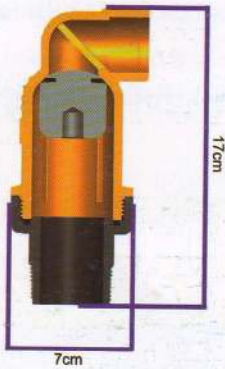

AV0210/AV0232

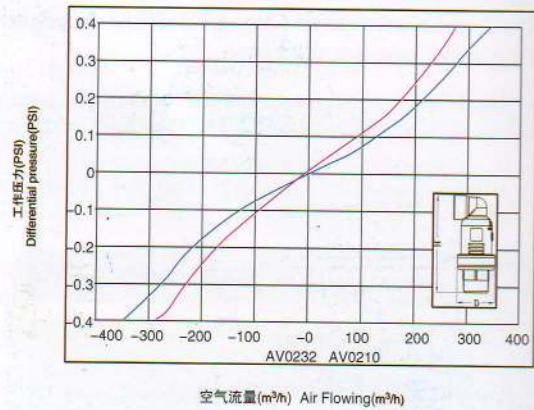

2" 排气阀技术参数 2" Air Valve Technical Data

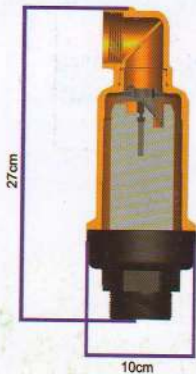

AV0150

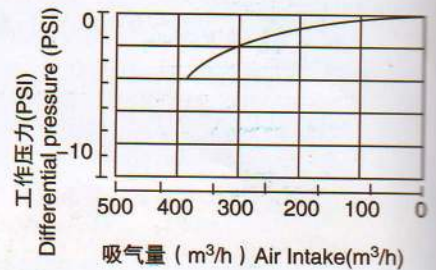
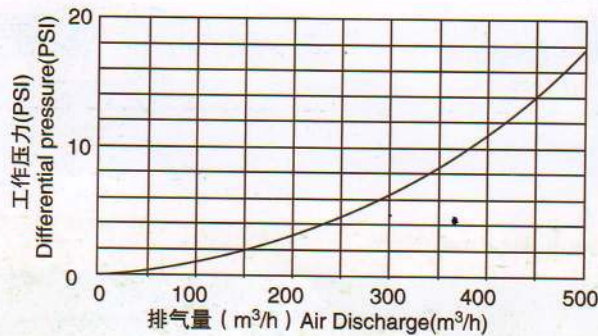

单位换算表 Conversion Table

压力 Pressure

| 从 From | 到 To | 倍数 Multiply by |
|--------------------|--------------------|----------------|
| kpa | psi | 0.145 |
| kpa | bar | 0.01 |
| kg/cm ² | psi | 14.22 |
| kg/cm ² | atm | 0.968 |
| bar | psi | 14.5 |
| bar | atm | 0.987 |
| atm | psi | 14.692 |
| atm | bar | 1.013 |
| psi | kg/cm ² | 0.07 |
| psi | kpa | 6.89 |

体积 Volume

| 从 From | 到 To | 倍数 Multiply by |
|-----------------|-----------------|----------------|
| m ³ | gal(USA) | 264.172 |
| m ³ | gal(UK) | 219.969 |
| m ³ | ft ³ | 35.315 |
| cm ³ | in ³ | 0.06 |
| ft ³ | m ³ | 0.028 |
| in ³ | cm ³ | 16.387 |
| L | pinta(US) | 2.113 |
| L | gal(USA) | 0.264 |
| L | gal(UK) | 0.22 |
| gal(USA) | m ³ | 0.004 |

流量 Flow

| 从 From | 到 To | 倍数 Multiply by |
|-------------------|-------------------|----------------|
| m ³ /h | gpm(UK) | 4.546 |
| m ³ /h | gpm(USA) | 3.785 |
| m ³ /h | L/S | 0.278 |
| gpm(USA) | L/S | 0.073 |
| gpm(USA) | m ³ /h | 0.264 |
| gpm(UK) | L/S | 0.061 |
| gpm(UK) | m ³ /h | 0.220 |
| L/S | gpm(USA) | 13.615 |
| L/S | gpm(UK) | 16.353 |

长度 Length

| 从 From | 到 To | 倍数 Multiply by |
|--------|------|----------------|
| km | mi | 0.621 |
| m | ft | 3.281 |
| cm | in | 0.0394 |
| mm | in | 0.394 |
| mi | km | 1.609 |
| ft | m | 0.305 |
| in | Cm | 2.54 |

灌溉用水量

$$W_{\text{日}} = 0.667 \times \frac{AE_p}{\eta}$$

$W_{\text{日}}$ —— 某块面积上日毛用水量 (m^3/d)

A —— 面积 (亩)

η —— 灌溉水利用系数

E_p —— 作物日需水量 (mm/d)

灌水定额

$$m = 0.1rH(\beta_1 - \beta_2)$$

m —— 设计灌水定额 (mm)

H —— 计划湿润层深度 (cm)

β_1, β_2 —— 适宜土壤含水量上下限 (重量百分比)

r —— 土壤干容重 (g/cm^3)

灌水周期

$$T = \frac{m}{E_p}$$

设计流量

$$Q_j = \frac{m \cdot A}{t \cdot T \cdot \eta} = \frac{E_p \cdot A}{t \cdot \eta}$$

$$Q_m = \frac{Q_j}{\eta_c}$$

Q_j, Q_m —— 系统设计净流量和毛流量 (m^3/h)

m —— 设计灌水定额 ($\text{m}^3/\text{亩}$)

A —— 灌溉面积 (亩)

T —— 设计灌水周期 (d)

t —— 每日净灌溉时间 (h)

η —— 田间水利用系数

η_c —— 输水系统水的利用系数

管嘴和小孔出流计算

$$Q = \mu A \sqrt{2gH_0}$$

Q 为流量, 单位 m^3/s

μ 为流量系数, 对于管嘴一般为 0.95, 对于孔口一般为 0.60~0.65

H_0 为出口前稳定段的总水头, 或者管道中的压力水头, 单位 m

A 断面面积, m^2

系统扬程计算

$$H = \Delta z + h_w + h_p$$

H —— 系统设计扬程

Δz —— 典型灌水器至水源水面的高度 (m)

h_w —— 水头损失

h_p —— 典型出水点灌水器的工作压力水头 (m)

沿程水头损失计算

$$h_f = f \frac{LQ^m}{d^b}$$

Q —— 管道中流量

L —— 计算管长 (m)

d —— 管道内径 (mm)

f —— 摩擦损失系数

m —— 流量指数

b —— 管径指数

规模不大的干管管径估算

当 $Q < 120 \text{m}^3/\text{h}$ 时, $D = 13\sqrt{Q}$

当 $Q \geq 120 \text{m}^3/\text{h}$ 时, $D = 11.5\sqrt{Q}$

D 是管径 (mm), Q 是每小时流量

微灌设计耗水强度

$$E_a = k_r E_c$$

$$k_r = \frac{G_c}{0.85}$$

E_a —— 微灌作为耗水强度, mm/d

k_r —— 作物的遮荫率对耗水量的修正系数, 当

由计算出的数值大于 1 时, 取 $k_r = 1$

G_c —— 作物的遮荫率

E_c —— 作物需水量, mm/d

微灌灌水均匀度

$$q_v = \frac{q_{\max} - q_{\min}}{q_a}$$

q_{\max} —— 流量偏差

q_{\min} —— 灌水单元中灌水器最大流量, L/h

q_v —— 灌水单元中灌水器最小流量, L/h

q_a —— 灌水单元中灌水器平均流量或设计流量, L/h

水泵需配套功率估算

$$W = \frac{QH}{200}$$

W —— 需配备的动力大小, Kw

Q —— 设计流量, m^3/h

H —— 水泵扬程, m